



TITANIUM SIGNATURE SERIES INSTALLATION MANUAL

ALL 1/2" FUEL PORTS



APPLICATION:

ND-TS-F16-250G
(250GPH @ 8-10PSI)
ND-TS-F16-290G
(290GPH @ 8-10PSI)

Powerstroke 6.4L
Standard Pickup Truck
2008-2010

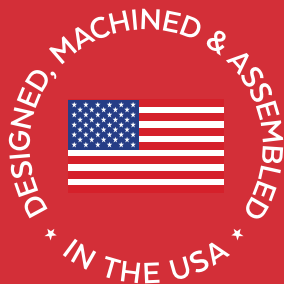

**Note: Cab and Chassis
may require modifications**



www.fassride.com

(866) 769.3747

Thank you for choosing FASS, from Diesel Performance Products, Inc.

FASS specializes in building extremely high-quality fuel products. We have earned an unsurpassed reputation for excellence in our industry by using only the highest-quality American-made components. In order to support our American workers and our American economy, more than 98+ percent of our products are manufactured completely in the United States.

Of course, that dedication to excellence comes at a price, but it is important to remember that price does not dictate quality-quality dictates price! We will never compromise by using cheaper, foreign-made components, like so many of our competitors do.

Customer satisfaction is our top priority and we strive always to provide outstanding customer service. Our Research and Development department, in conjunction with our Dealer Support Department, continually searches for ways to improve quality, expand our product line, and provide superb support. Our exclusive ViP Network ensures that customers receive the proper products and support at the local level. The extended lifetime warranty is only available on products purchased from the network. There is no warranty on products not purchased outside the network.

IMPORTANT:

In order to qualify for the lifetime extended warranty, your product registration form and proof of purchase from an authorized dealer must be submitted to FASS Fuel Systems within 30 days of purchase. Failure to comply will void the warranty. We have the right to deny any warranty believed to be false, altered or purchased through an unauthorized or terminated dealer. A current list of authorized dealers can be found on our website, FASSRide.com.

The complete conditions of the Limitation of Warranty can be found in the back of this manual, and FASSRide.com.

**For more information,
contact Technical Support:
Diesel Performance Products, Inc.
16234 State Hwy O Marthasville,
MO 63357
636-433-5410**



WARNING!

This product has NO WARRANTY unless:

1. It has been purchased from an **Authorized or **ViP FASS Dealer**. If in doubt, check www.FASSRide.com.**

2. It is registered within thirty (30) days of purchase.

Other conditions may apply. Please see full warranty information.

***NOTE:* Warranty is **void** if product was purchased below FASS website advertised pricing.**

ATTENTION!

Before you begin installation

Register for your Warranty ONLINE at

<https://www.fassride.com/register-a-warranty/>

No online access, call our TECH Support at

1-866-769-3747

FOLLOW THESE STEPS TO ENSURE A SIMPLE, CORRECT INSTALLATION OF YOUR NEW TITANIUM FUEL SYSTEM

ATTENTION:

Be sure to identify the proper FASS System and fuel line configuration. For help, our product finder can be found at www.FASSride.com. Follow the instructions to see fuel line detail.

- 1** Be sure the serial number on this installation manual matches that on the outside of the box.
- 2** Pay close attention to ALL WARNINGS
- 3** Read all instructions before starting installation of this product.
- 4** Inventory the package components. Notify the place of purchase immediately of any parts missing or damaged.
- 5** The installation recommendations contained herein are guidelines. Use good judgment and take into consideration your vehicles' accessories.
- 6** For best results in accuracy and efficiency (due to training, communication, and our relationship with our dealer network), we recommend a VIP FASS dealer for the installation. They are prepared to install the FASS fuel pumps with the most efficiency. If a situation or problem arises during the installation, the dealer is prepared to handle it. Diesel Performance Products, Inc. is not responsible for any installation mistakes.
- 7** If you have any questions or concerns that cannot be addressed with your dealer, email or call FASS.

**If any installation procedure is uncertain, contact FASS technical support.
Call customer service at 636-433-5410,
or send us an e-mail: techsupport@FASSride.com
with the following information:**

Your name, address and daytime phone number
Model (ND-TS-F16-250G) or (ND-TS-F16-290G)
Serial Number
Last 6 digits of vehicles' VIN

Date of purchase
Nature of Your Concern
Serial number



INSTALLATION MANUAL

ND-TS-F16-250G or ND-TS-F16-290G

(Installation Videos are available at www.fassride.com)

RECOMMENDED APPLICATION

ND-TS-F16-250G: Powerstroke (6.4L) 2008-2010 with extreme horsepower modifications

ND-TS-F16-290G: Powerstroke (6.4L) 2008-2010 with extreme horsepower modifications

1. **Read all instructions before starting installation of this product!**
2. **Installing the improper FASS Pump can cause severe engine damage.**
3. **Secure vehicle from ROLLING!**
4. **Cab and Chassis may require modifications**
5. **Consult vehicle's manufacturers' instructions concerning the electrical system before attempting any electrical connections.**
6. **Be sure that the serial # on this installation manual matches that of the outside of the box.**
7. **Flush and clean all brass fittings and fuel line from debris.**
8. **Keep debris from entering the internals of the system during installation. Getting debris in the water separator nipple can lock up the motor. If the motor does lock up from debris call FASS for technical assistance.**

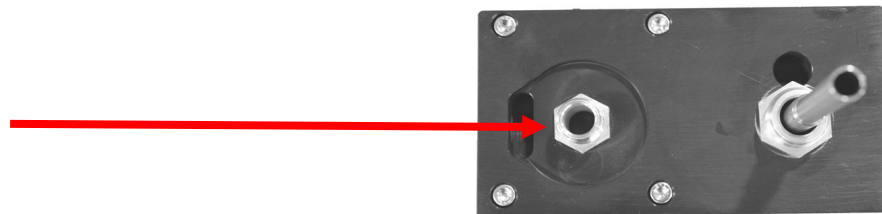

9. **Wear safety glasses when operating power tools such as drills and grinders or when using a punch or chisel.**
10. **Properly secure lines to prevent chaffing.**

BEFORE STARTING THE INSTALLATION PROCESS LUBRICATE THE BED BOLT WITH WD-40 TO HELP WITH INSTALLATION



WARNING!

Always be sure to fill the fuel tank to full after a new FASS installation. Failure to do so can result in excessive sound output, or priming issues!

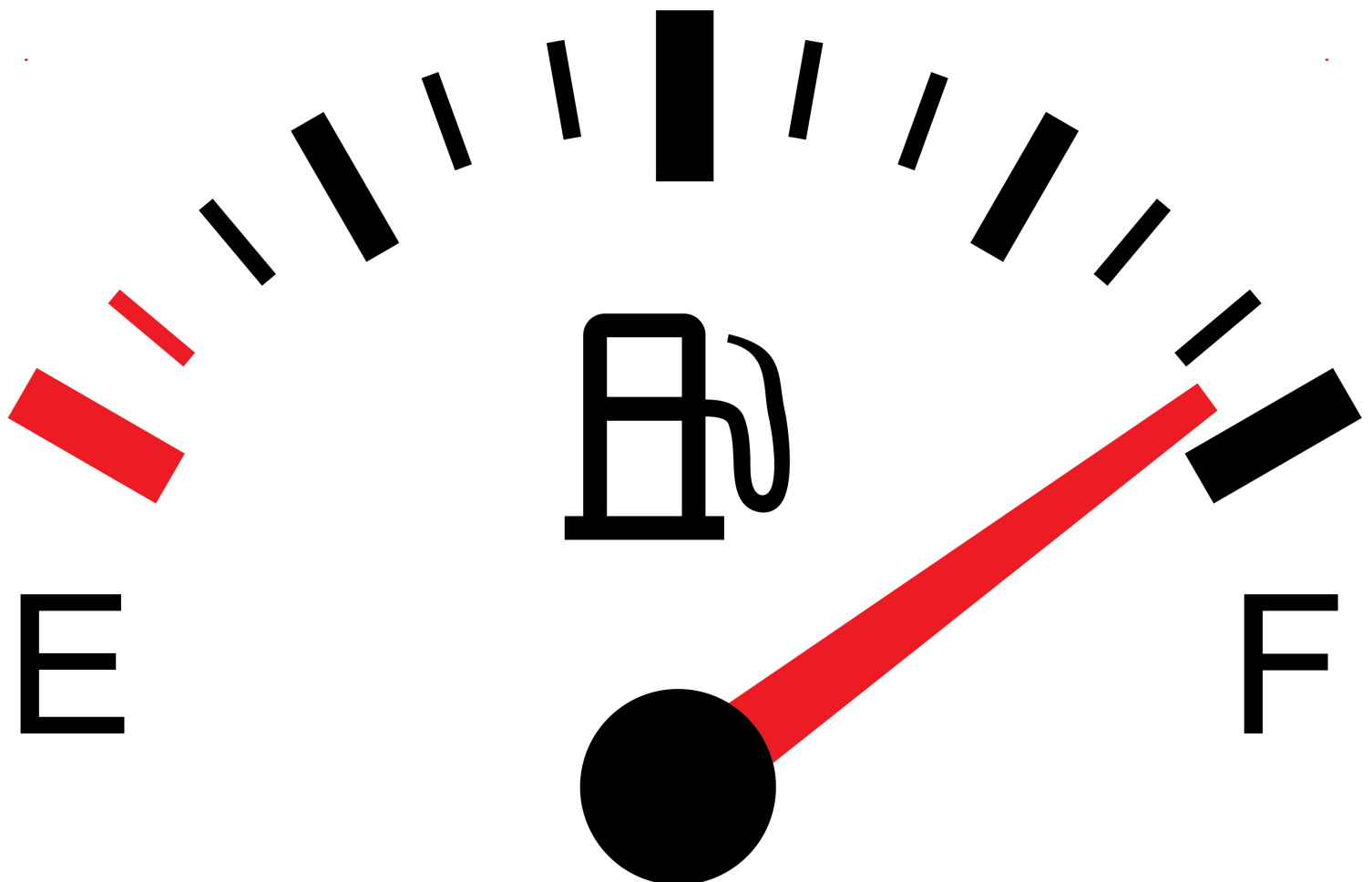

TITANIUM **Signature SERIES** **250GPH or 290GPH** **8-10 psi (Approximately)**

Rear View



Front View



PUMP GUIDE:

- 1. "E" To Engine**
- 2. "R" Return to Tank**
- 3. Serial Number**
- 4. "T" Fuel Inlet**
- 5. Electric Heater Ports**
- 6. "G" Gauge Port**

INSTALLATION GUIDE:

- Step 1. Install Electrical Harness**
- Step 2. Prep the FASS**
- Step 3. Mount the FASS**
- Step 4. Fuel Line Supply**
- Step 5. Review Installation**



www.fassride.com
(866) 769.3747

TITANIUM SIGNATURE SERIES 250 GPH or 290 GPH

8-10 PSI (Approximately)
Note: Going over 80 PSI WILL void warranty.

**NOTE: WARRANTY MAY BE VOID IF SILICONE
BAND IS REMOVED FROM MOTOR!!**

*The silicone band is in place to retain motor
wires, preventing damage to the electric motor.*



CONTENTS

NOTE: Owner's Manual available for download on our website,
www.FASSride.com



SP-5501



OR-350VITON



SC-5501

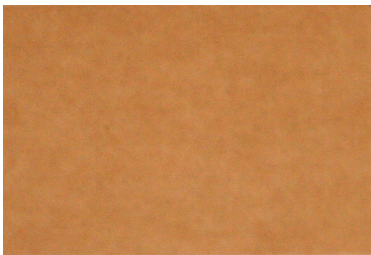

MP-9054-2-ND



FL-1002X9'

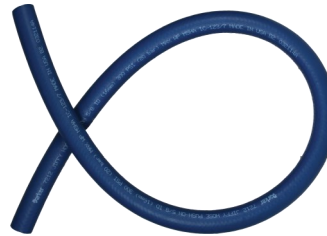

FL-1058X3'



WH-1006-3



DIELECTRIC GREASE



OR-030



**TWO (2)
OR-017**

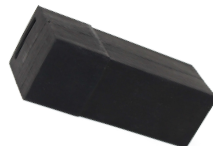

RELAY COVER



PBR-2001

PFB-2002



PFB-2001C

NOTE: THESE SPARE BASE O-RINGS ARE INCLUDED WITH THE KIT IN THE EVENT OF A PINCHED O-RING DURING ASSEMBLY

MOUNTING PACKAGE CONTENTS

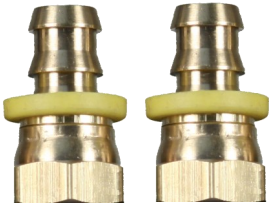

(TWO)
PL-1005



10-300



PL-1010



PL-1004



PL-1058



10-302



TWO (2) RING
TERMINAL



HEX BOLT
1/2" -20x1
3/4"



PLB-1212



TWO (2) PLB-1238



1/2" WASHERS



46044



46251



SHCS 3/8" -16x2"



0424860



THREE (3)
HEX BOLT
1/4" -20x1
3/4"

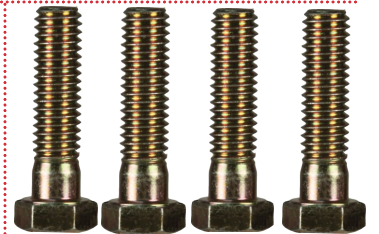

FOUR (4) Hex Bolt 3/8"
-16x1 1/2"



THREE (3) WA-1001D



FOUR (4)
3/8"
WASHERS



FOUR (4) LOCKING
NUT 3/8"



CABLE TIES

MOUNTING PACKAGE CONTENTS



RS-2001C



RS-2001

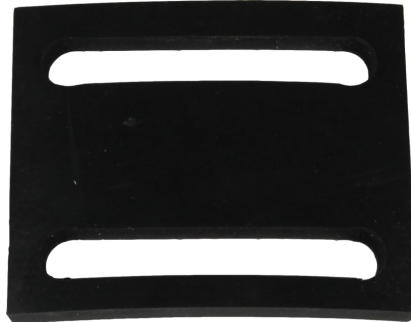

RS-2002

STEP 1:
INSTALL ELECTRICAL HARNESS

The installation of the electrical harness is done first, allowing power to be applied to the pump for lubrication purposes later in the installation.

**NOTE: USE SUPPLIED DIELECTRIC GREASE
SPARINGLY ON ALL ELECTRICAL
CONNECTIONS! BE SURE TO GREASE RELAY
PIGTAIL!**



STEP 1:
INSTALL ELECTRICAL HARNESS

The installation of the electrical harness is done first, allowing power to be applied to the pump for lubrication purposes later in the installation.

Install the Relay Cover onto the relay on the FASS harness.

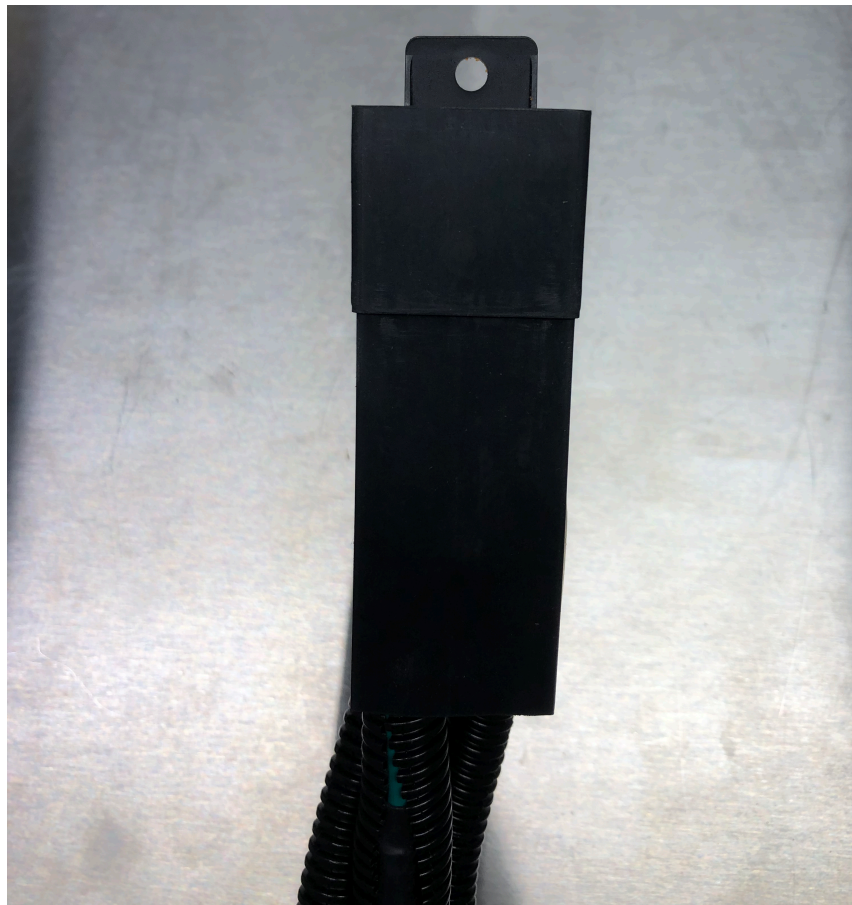

STEP 1:
INSTALL ELECTRICAL HARNESS

The installation of the electrical harness is done first, allowing power to be applied to the pump for lubrication purposes later in the installation.

**NOTE: BE SURE TO INSTALL THE SUPPLIED
30 AMP FUSE INTO THE FASS WIRING
HARNESS!!**



STEP 1: **INSTALL ELECTRICAL HARNESS**

- A.** Using wire stripping tool remove excess insulation off the ADD-A-CIRCUIT 46044 and the RED single wire of WH-1006-3



- B.** Place wire from ADD-A-CIRCUIT 46044 and WH-1006-3 into butt connector. Using crimping tool connect ADD-A-CIRCUIT 46044 and WH-1006-3 with butt connector. Install 46251 to ADD-A-CIRCUIT 46044 TOP slot. (Near the added circuit/wire). Route ADD-A-CIRCUIT 46044 lead through the fire wall using existing grommet.

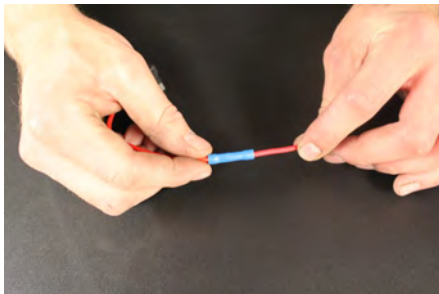

- C.** Crimp the ring terminals to the red and green wires of the WH-1006-3 Wire Harness. Attach red wire to the positive terminal of the battery and the green wire to the negative terminal. The use of a corrosion preventative on electrical connections is recommended.



STEP 1: **INSTALL ELECTRICAL HARNESS**

The installation of the electrical harness is done first, allowing power to be applied to the pump for lubrication purposes later in the installation.

D. Secure Relay in an upright position, as shown, to prevent moisture from entering. Apply dielectric grease to relay pigtail.



E. Using wire crimpers, connect the 46044 to the RED single wire of WH-1006-3. Route the extension to the engine bay fuse panel, remove a fuse (maximum of 10A) that is “hot” when the key is on. Use a test probe to locate the “hot side” of the circuit in the fuse block. Install the fuse tap into the open location. Install the pulled fuse into the open space on the fuse tap. Disconnect the vehicles’ battery and continue installation.

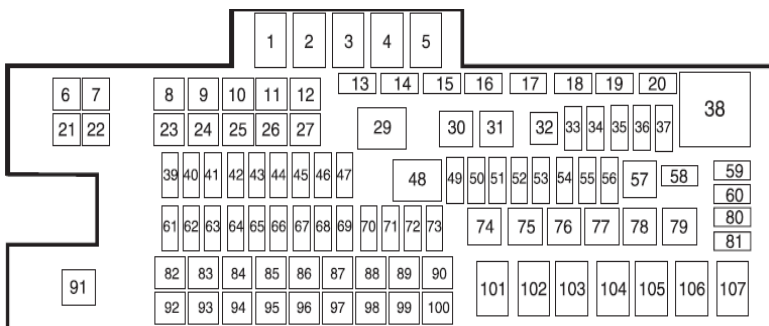

STEP 1: INSTALL ELECTRICAL HARNESS

NOTE: If the truck has a no start/no crank condition after the FASS installation, this could be caused by O.E.M. fuel pump codes (P0232) as this was disconnected during the FASS installation process. To correct this issue one of the two methods bellow can be used.

1. Trigger the FASS relay using the O.E.M pump circuit by connecting the RED single wire of WH-1006-3 to the O.E.M lift pump positive wire. You will also need to connect the O.E.M lift pump negative wire to a ground source on the frame.

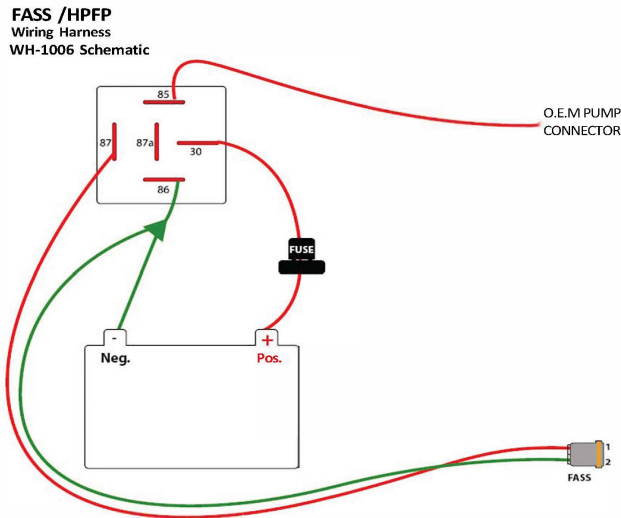

2. Wire a 10 ohm 50 watt resistor into the O.E.M. lift pump circuit to fool the ECU and prevent this condition.



NOTE:

ATTENTION: While installing fittings into Titanium pump **DO NOT** Apply side pressure to draw tube of pump

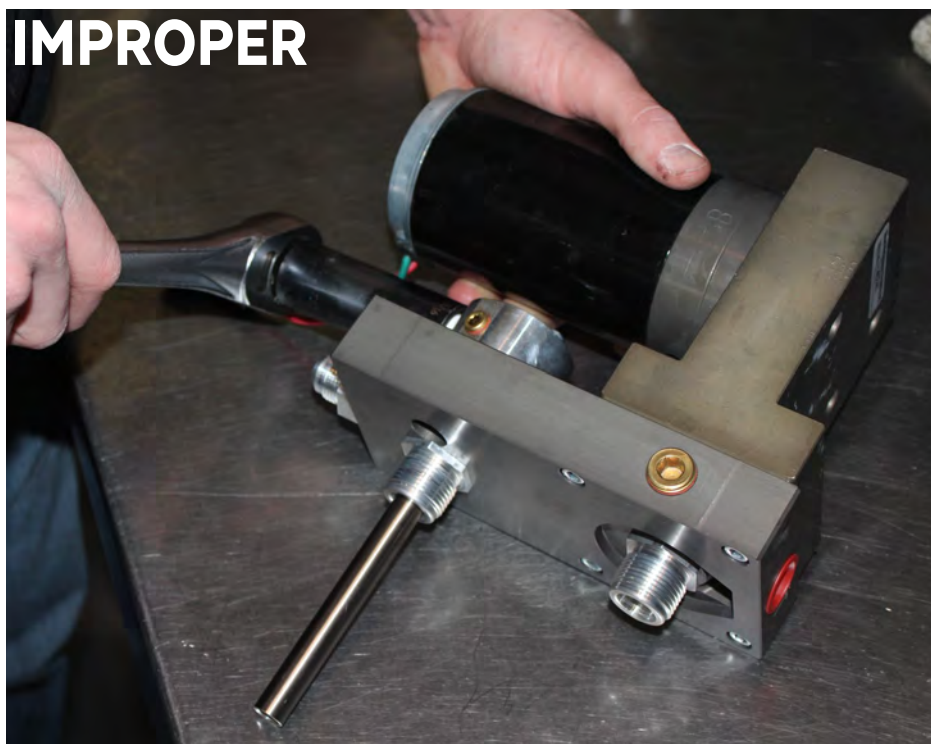

STEP 2: MOUNT FUEL SYSTEM

NOTE: Before installing fittings make sure to inspect for burs or flare imperfections. When cutting fuel line make sure to blow out line to keep debris from moving forward.

- A. Install 10-300 into the "E" port and 10-302 into the "T" port of the FASS, torque to 20 ft./lbs.
FITTINGS COME EQUIPPED WITH THREAD SEALANT, DO NOT USE THREAD TAPE

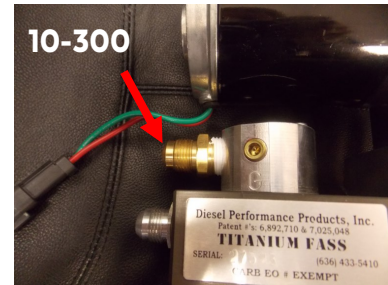
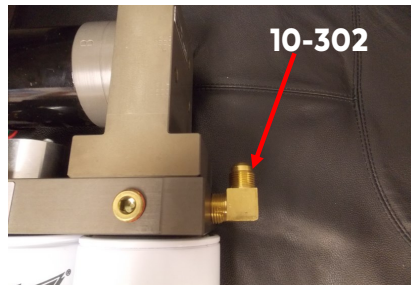

- B. For fitting purposes. Secure PBR-2001 to pump assembly lightly with (3) 1/4"-20x1 3/4 bolts and (3) WA-1001D. Assembly will be used in future steps for correct fitting of brackets. (Note: Bracket may-be flipped to accommodate your application.)

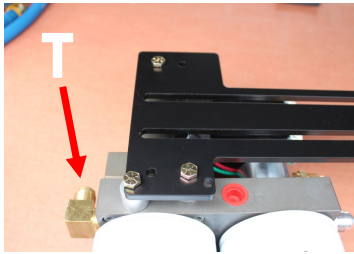
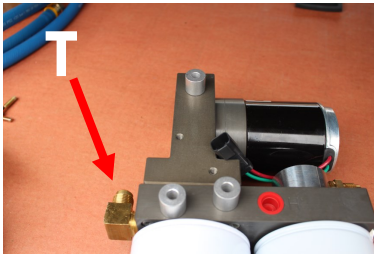

STEP 2: **MOUNT FUEL SYSTEM**

C. Assemble PFB-2002C and RS-2001C RS will make contact with bed channel when assembled correctly. Insert the PFB-2002C assembly in to bed channel align the nut with the opening on the channel.



D. Secure PFB-2002 and RS-2001 with (1) hex bolt 1/2" -20 x 1 1/2" and (1) 1/2" washer to PFB-2002C

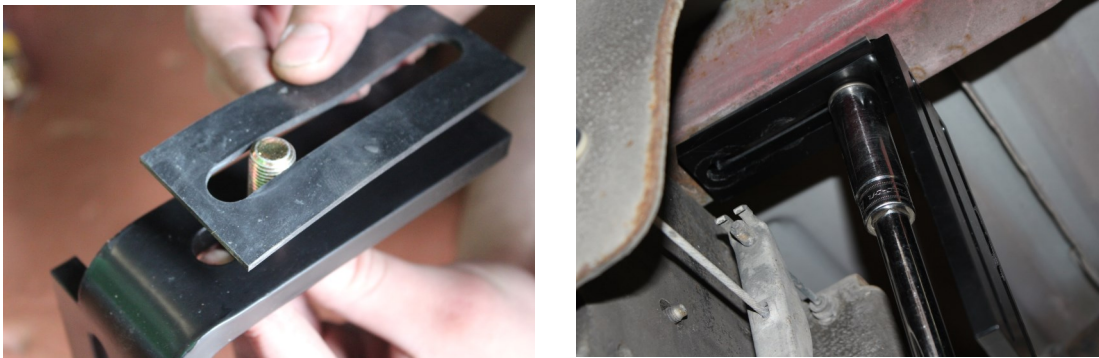

E. Disconnect the factory power plug to the HFCM lift pump. Using electrical tape or heat shrink, seal the factory connector to prevent water/debris intrusion.



STEP 2: **MOUNT FUEL SYSTEM**

F. Turn key to “on”. With pump operating (you may have to bump the starter), turn pump over, liberally spray WD-40 (or equivalent) into water separator nipple lubricating Gerotor.

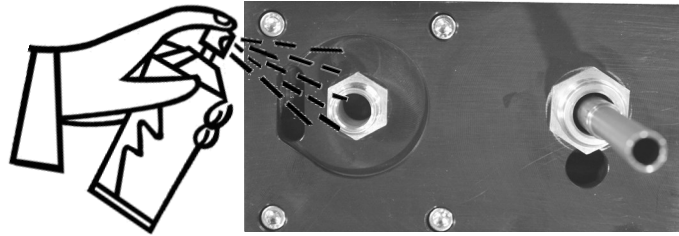

G. Position the PBR-2001 to the PFB-2002 pump assembly at the mounting location and check for fit. Once location is established mark location for mounting in next step.



H. Assemble the FASS pump bracket PBR-2001 using the RS-2002 spacer between PFB-2002 and PBR-2001 bracket with 4-3/8 bolts, nuts, and washers. Note: Torque bolts not flange nut.

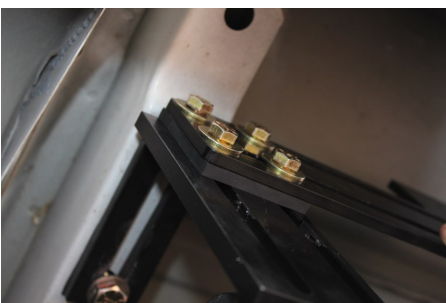
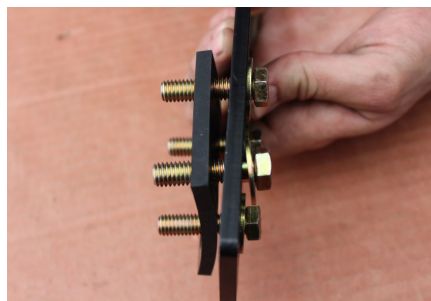
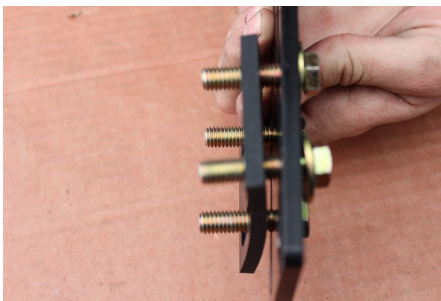

STEP 2: **MOUNT FUEL SYSTEM**

- I. Once secure use 3-1 3/4 bolts and 3-WA-1001D spacers to mount the pump to the bracket.

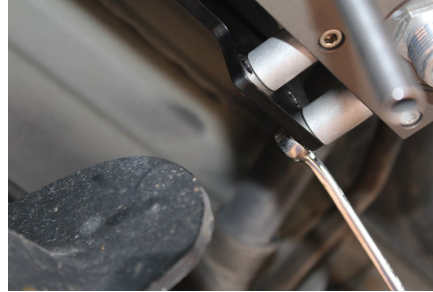

- J. Apply motor oil to gasket located on filters. Attach to system and hand tighten.



**Extreme Water Separator -
Install XWS-3002 on side of
pump with draw tube in the
middle of the filter nipple.**



**Particulate Filter -Install PF-3001 on
filter nipple without the draw tube.
Make sure to insert O-Ring provided
on nipple.**

STEP 3: **SUMP INSTALLATION**

A. Remove the OEM fuel tank skid plate.

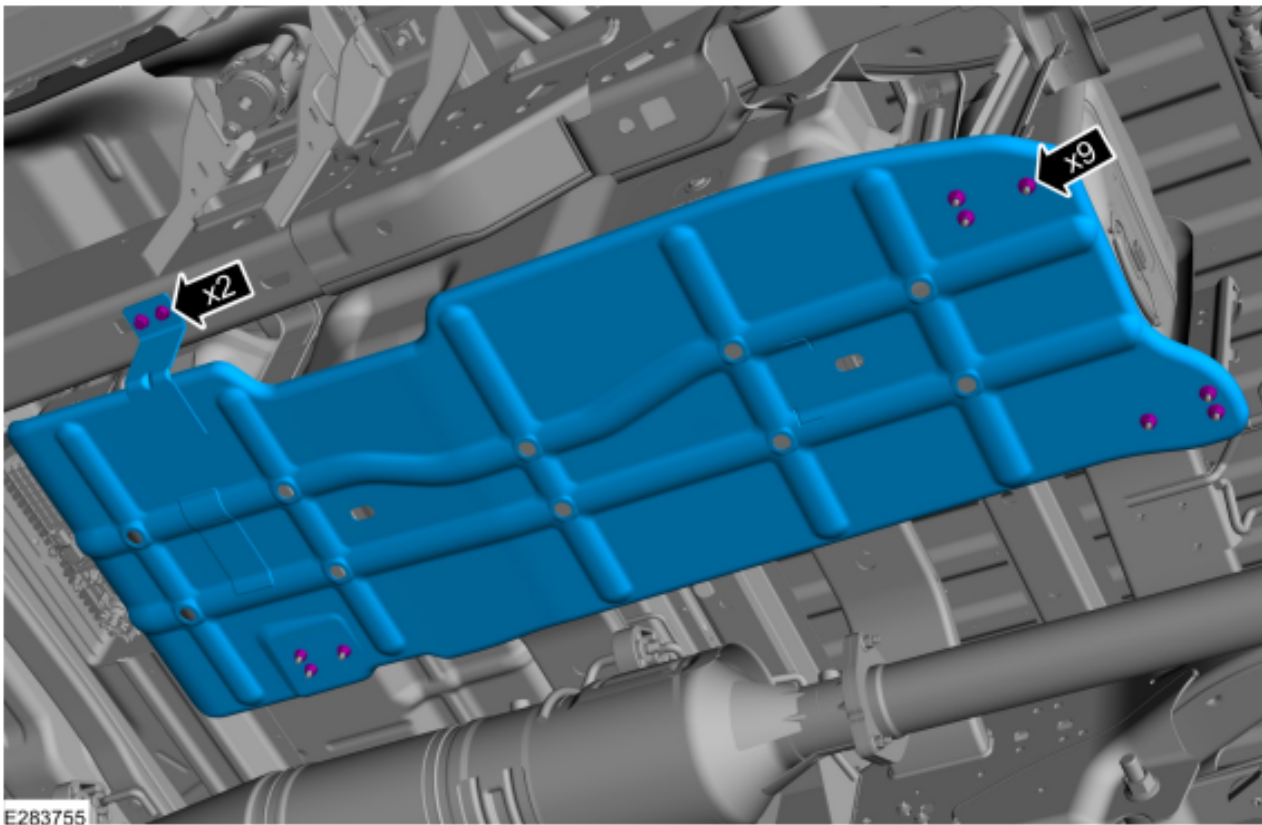

STEP 3: **SUMP INSTALLATION**

B. Locate the lowest point of the fuel tank, which is typically below the factory fuel module. On some applications there is a dimple you can use for a center point reference and it has the flattest surface for sealing the sump.



STEP 3: **SUMP INSTALLATION**

C. Using the center point, drill a small hole to drain the remaining fuel. Recommend having a container large enough to retain the remain fuel. Allow fuel to drain completely.



STEP 3: SUMP INSTALLATION

- D. Using a 3-3/4" hole saw drill the center point previously marked or notated.



STEP 3: SUMP INSTALLATION

E. Deburr hole and remove all shavings.



STEP 3: SUMP INSTALLATION

F. Install SC-5501 into fuel tank positioned as shown.

NOTE: THIS SIDE FACES SP-5501

NOTE: THIS SIDE FACES THE INSIDE OF TANK

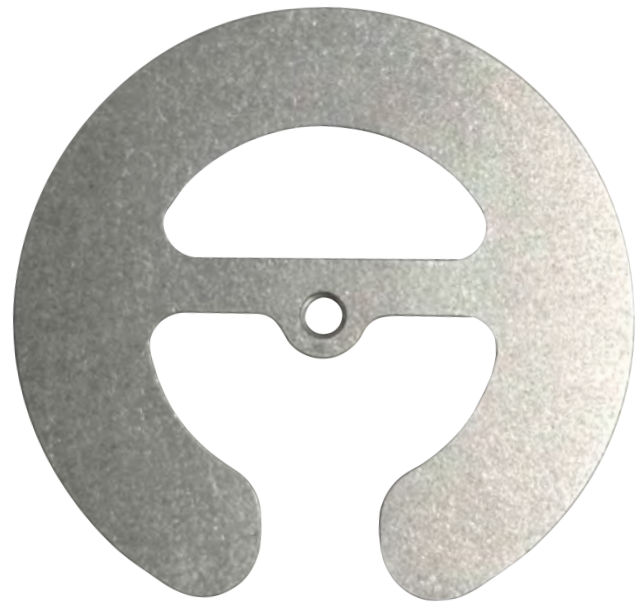

STEP 3: **SUMP INSTALLATION**

- G.** Using grease, install OR-350VITON into the groove of SP-5501



STEP 3: SUMP INSTALLATION

H. Install the supplied 3/8-16x2" SHCS through O424860 and hand tighten SP-5501 into place.



NOTE: O424860 MUST BE INSTALLED BEFORE TIGHTENING SP-5501 INTO PLACE



STEP 3: **SUMP INSTALLATION**

I. Rotate SP-5501 to your desired position and torque the 3/8-16x2" SHCS to 12 FT/LBS .



STEP 3: **SUMP INSTALLATION**

NOTE: YOU WILL NEED TO USE A HOLESAW OR SIMILAR TOOL AND CUT A CLEARANCE HOLE IN THE SKID PLATE FOR THE SUMP.

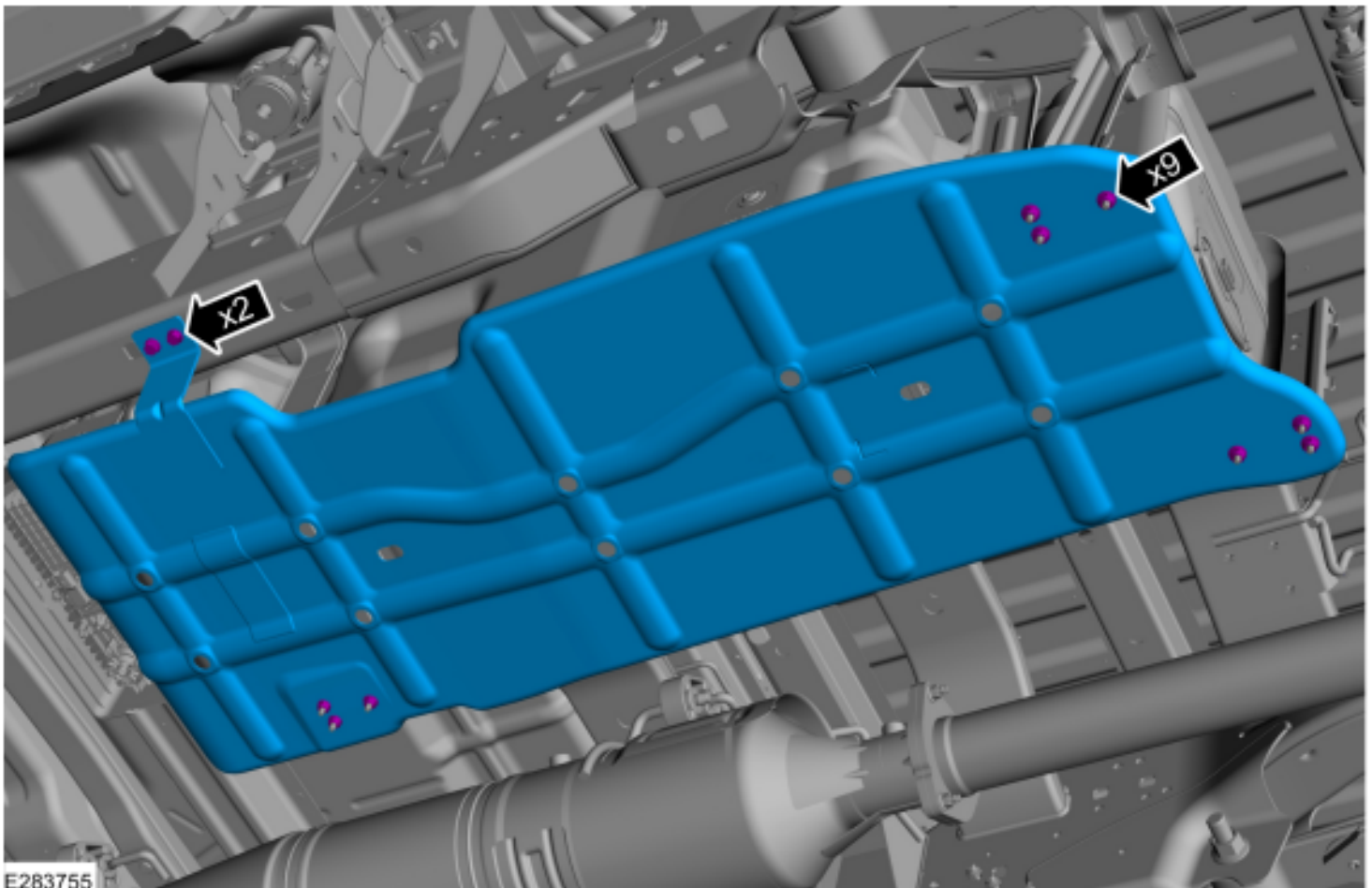

STEP 3: SUMP INSTALLATION

NOTE: RETURN PORT AND POCKET



NOTE: SUPPLY PORT AND POCKET



STEP 3: SUMP INSTALLATION

- I. Install PL-1004 into the return port of SP-5501 and tighten accordingly.



STEP 3: SUMP INSTALLATION

J. Install PL-1010 into the suction port of SP-5501 and tighten accordingly.



STEP 4: **INSTALL FUEL LINE**

A. Using grease, press FL-1002 onto the return port PL-1004. Route FL-1002 to the 'R' port of the FASS pump and cut to length. Using grease, press FL-1002 onto PL-1005 and tighten accordingly.



STEP 4: **INSTALL FUEL LINE**

B. Using grease, press FL-1058 onto the suction port PL-1010. Route FL-1058 to the 'T' port of the FASS pump and cut to length. Using grease, press FL-1010 onto PL-1058 and tighten accordingly.

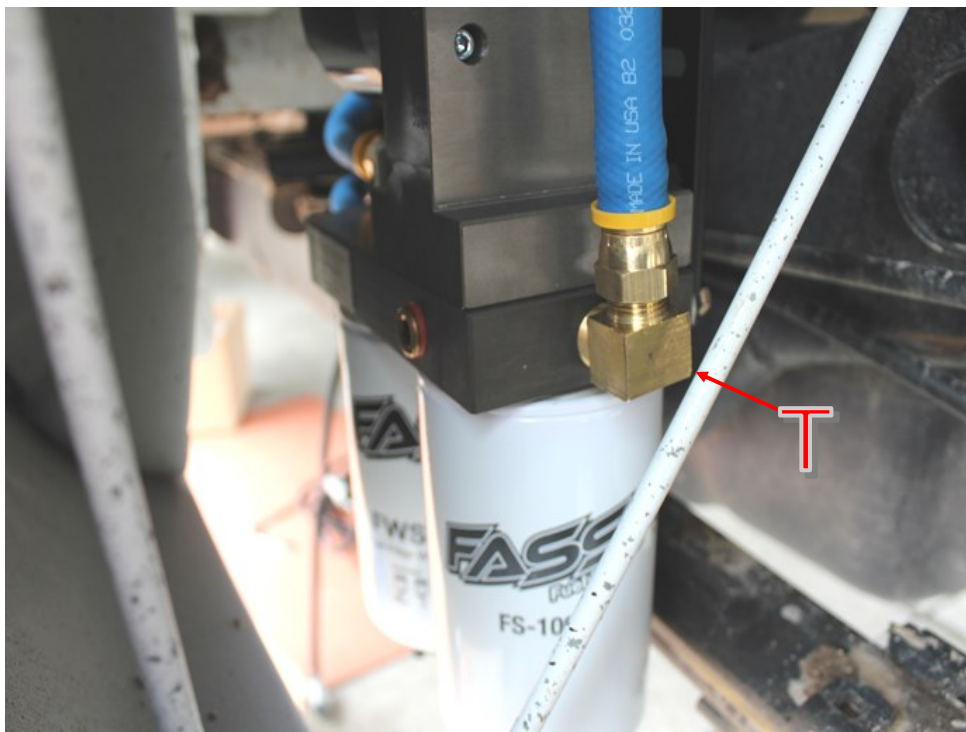

STEP 4:

INSTALL FUEL LINE

Caution: DO NOT use sealant on AN fittings

C. Insert PL-1005 into remaining fuel line using oil. Attach fuel line to the 'E' port of the FASS system. Torque to 18 ft./lbs. Route this line to the engine side of the factory lift pump. Do not cut at this time.



D. Bypass factory fuel pump.

E. Drain fuel from factory pump/filter using a 6mm hex drive, turning it counterclockwise.



F. Using quick disconnect tools, remove the fuel lines from the front of the factory fuel pump. Remove the fuel lines attached to the rear of the factory fuel pump by pressing in on the tabs.

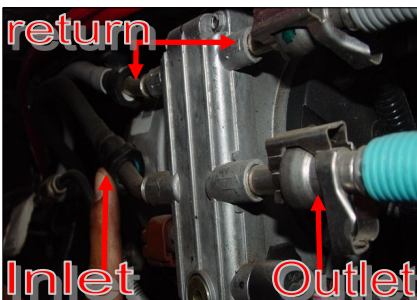

STEP 4: **INSTALL FUEL LINE**

G. Route the fuel line from the 'E' port of the FASS to the factory lift pump's outlet quick disconnect and cut to length. Insert the PLB-1212 into FASS fuel line using oil. Slide the PLB-1212 into the factory quick disconnect until you hear a click. Lock down factory retainer clip.

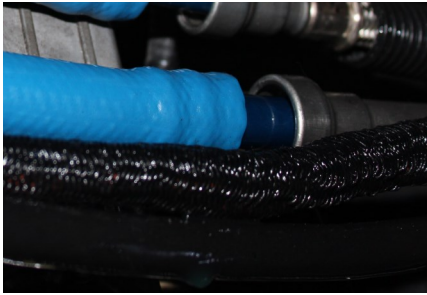

H. Measure between the two factory return fittings. Insert two PLB-1238 fittings into the provided FL-1002 fuel line using oil. Insert fuel line into factory quick disconnects until you hear a click. Lock down retainer clip. Secure fuel line.

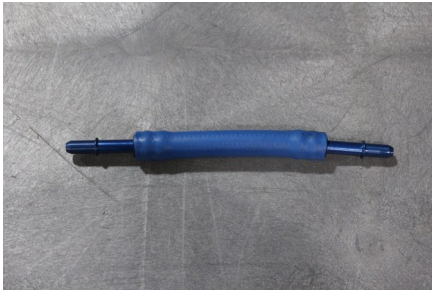

Note: Secure all fuel lines with cable ties. Cable ties are an economical way to prevent the possibility of problems occurring!

STEP 4: **INSTALL FUEL LINE**

I. We recommend putting approximately 5 gallons of fuel in the tank prior to filling the tank to check for fuel leaks. Prime the FASS system and check for leaks. Once you confirm no fuel leaks, the tank can be filled to capacity.



STEP 5: **REVIEW INSTALLATION**

To assist with priming your FASS pump crack the FF-3003. Put power to the FASS pump to activate the pump. When the tone of the pump changes you can tighten up the fuel filter. If you need a video of the priming process go to www.FASSride.com.



Note: The Red Plastic Plugs located in the “H” ports can stay in place fuel will not flow through these ports. Coolant can be plumbed into these ports to heat the fuel in the Winter months.

STEP 5: **REVIEW INSTALLATION**

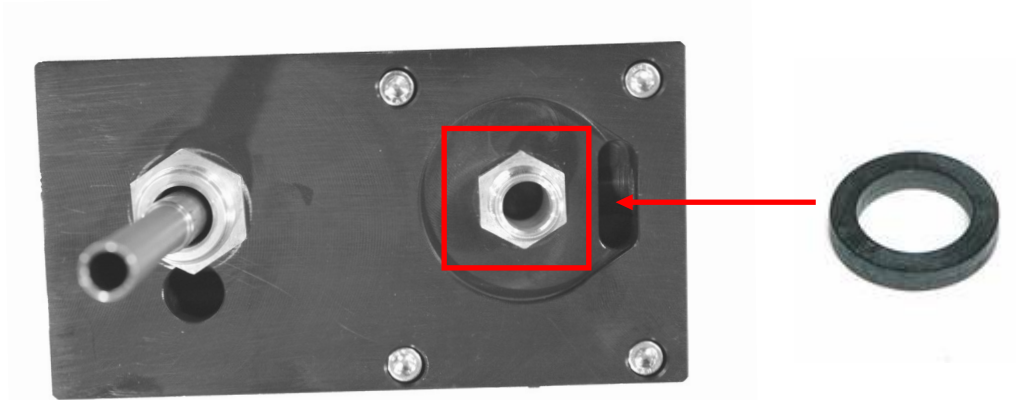

Note: O-Ring must be put back on suction side of pump. Failure to do so can result in priming issues, cavitation, or pressure losses.

1. Blow out any open lines/cover any open ports
2. Bolts and fasteners properly tightened?
3. Electrical harness and fuel lines secured and properly tightened? Reconnect the battery.
4. Has the system been primed?
 - a. Turn key to the ignition position, turning on the FASS pump for 15 sec..
 - b. Crank engine and allow to run for at least 1 minute.
5. Check for leaks.
6. Start the engine
7. Recheck all fluid and filter connections for leaks
8. This pump comes with a 1 Year Manufacturer's Warranty based on the date it has been manufactured. To receive your extended Lifetime Warranty, you have 30 days from date of purchase to complete warranty information ONLINE at <https://fassride.com/register-a-warranty/>



www.fassride.com

(866) 769.3747

LIMITATION OF LIFETIME WARRANTY

Disclaimer: To help insure you receive the proper system and customer support at the local level, FASS has a VIP and Authorized Dealer network representing FASS products. This is one reason you must purchase through a dealer to comply with our warranty policies. If you do not, there is no warranty! We recommend you go to www.FASSride.com, click "Find a Dealer", put in their ZIP code, select the type of dealer, and see if the company you purchased from is listed. If they are not, put their phone number in the field below the ZIP code field to see if they are listed. Below these two fields is a list of "Terminated/Unauthorized" dealers. You may want to review this list. If the company is not listed or is on the "Terminated/Unauthorized" list, we suggest you return the product immediately to that dealer and call FASS. We'll recommend you to the nearest dealer.

Diesel Performance Products, Inc. (hereafter "SELLER") gives Limited Warranty as to description, quality, merchantability, fitness for any product's purpose, productiveness, or any other matter of SELLER'S product sold herewith. The SELLER shall be in no way responsible for the product's open use and service and the BUYER hereby waives all rights other than those expressly written herein. This Warranty shall not be extended or varied except by a written instrument signed by SELLER and BUYER.

When MANUFACTURER receives the "ORIGINAL" PRODUCT REGISTRATION form with a copy of the "BILL OF SALE/SALES RECEIPT" within 30 days of the sale, then the following applies! The Warranty will then and only then be validated to that of which typically accompanies your unit for your specific application from the date of sale or for recommended service life and limited solely to the original purchaser and/or vehicle and parts contained within the product's kit. This warranty does not cover normal wear on consumable items such as but not limited to filters, fuel line, wire harness & etc. The warranty does not cover seized gears due to lack of filtration. Warranty is voided if used with other than diesel fuel. Returned items will arrive prepaid to the place of purchase. Diesel Performance Products, Inc. will repair, without cost, any product found to be defective during the warranty period; parts only, or at its option, will replace such products in exchange for the product. Repair or replacements are warranted for the remainder of the original warranty period. All Warranty claims are subject to approval by Diesel Performance Products, Inc.

A Return Material Authorization (RMA) number must be obtained before any product is to be returned to Diesel Performance Products, Inc. for warranty consideration, repair or product return. Requests for product returns must be offset by an equal value order. Return parts must be completed and in resalable condition. No returns after 30 days.

The following information is required to obtain a RMA number before returning product:

Your Name, Address, and Phone Number's

Model and Serial Number (Not Motor Number) Example: Model HD Series, Serial: 00125966 VIN Number of Vehicle

Date of Purchase

Nature of Problem

RMA and Product Serial Number must be on all paperwork and correspondence. Failure to obtain the required information or paperwork will result in \$25.00/item penalty and delay or denial of any warranty claim.

Under no circumstances shall the SELLER and/or MANUFACTURER be liable for any labor charged or travel time incurred in diagnosis for defects, removal, or reinstallation of this product, or any other contingent expenses.

Under no circumstances shall the SELLER and/or MANUFACTURER be liable for any damage or expenses insured by reason of the use or sale of any such equipment. This warranty does not apply to products which Diesel Performance Products, Inc. has determined to have been misused or abused, improperly maintained by the user, or where the malfunction or defect can be attributed to the use of non-genuine Diesel Performance Products, Inc. parts.

IN THE EVENT THAT THE BUYER DOES NOT AGREE WITH THIS AGREEMENT: THE BUYER MAY PROMPTLY RETURN THIS PRODUCT, IN A NEW AND UNUSED CONDITION, WITH A DATED PROOF OF PURCHASE, TO THE PLACE OF PURCHASE WITHIN THIRTY (30) DAYS FROM DATE OF PURCHASE FOR A FULL REFUND LESS SHIPPING.

THE INSTALLATION OF THIS PRODUCT INDICATES THAT THE BUYER HAS READ AND UNDERSTANDS THIS AGREEMENT AND ACCEPTS ITS TERMS AND CONDITIONS.



www.fassride.com
(866) 769.3747

NOTES: