

Fuel Tank

advanced FLOW engineering

Instruction Manual P/N: 42-31001

Make: Ford Model: F-250/F-350 Superduty CC/SB Year: 2008-2010 Engine: V-8 6.4L(td)



- Please read the entire instruction manual before proceeding.
- **Ensure all components listed are present.**
- For technical support please call 951-493-7185.
- **Ensure you have all necessary tools before proceeding.**
- **Do not attempt to work on your vehicle when the engine is hot.**
- **Retain factory parts for future use.**

Label	Qty.	Description	Part Number
A	1	Fuel Tank: 42-31001	05-4231001
B	1	Strap, Fuel Tank: Front	05-61125
C	1	Strap, Fuel Tank: Rear	05-61126
D	2	Insulator, Fuel Tank Strap	05-61236
E	3	Plug, 1/2" NPT	03-50249
F	1	Fitting, 1/2" NPT x 3/4" Barb	05-01705
G	2	Fitting, Safety Valve Gas Tank Rollover	03-50760
H	1	O-Ring, Buna-N (-359)	03-50763
I	8	Nut, Round Push 3/8" Screw Size	03-50654
J	8	Nut, Nylon Insert Lock: 3/8"-16	03-50762
K	21	Hose, Fuel: 5/16" ID, Black	05-00112
L	4	Hose, Fuel: 5/16" ID, Black	05-00112
M	1	Ring, Fuel Sender Locking: Outer	05-61123
N	1	3/8 Extension Hose	05-61241
O	1	1/2 Extension Hose	05-61242
P	1	Gasket, Fuel Tank Seal	05-61123
Q	2	Ring, Fuel Sender Locking: Inner	05-61124

Installation will require the following tools:

8mm nut driver, 3" / 6" / 12" extension, ratchet, 8mm socket, 10mm socket, 13mm socket, 13mm (12 pt) socket, 9/16 socket, hammer, standard screwdriver, jack, adjustable wrench, pliers,

Warranty Information available at <https://afepower.com/contact#warranty>

Emissions Disclaimer: This product is not currently CARB exempt and is not available for purchase in California or for use on any vehicle registered with the California Department of Motor Vehicles.

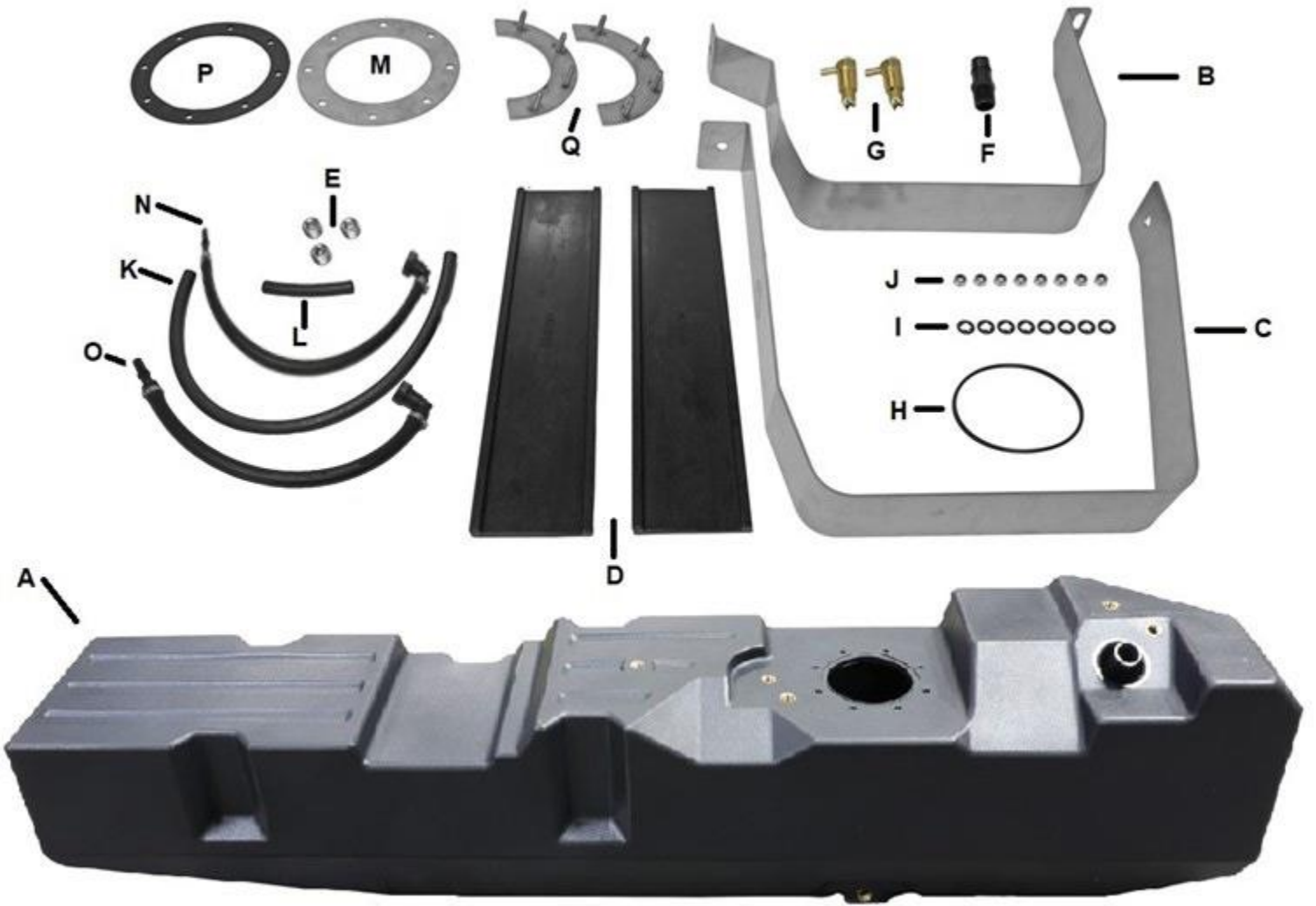

**Figure A****Refer to Figure A for Step 1:**

NOTE: Make sure the vehicle is safely parked with the parking brake set and the wheels chocked.

NOTE: Make sure the fuel tank gauge is reading $\frac{1}{4}$ tank or less prior to installation.

Step 1: If your truck is equipped with a factory fuel tank skid plate (1), it will need to be removed prior to installation. Remove the hardware and the retaining nuts from the frame. They will not be reused.

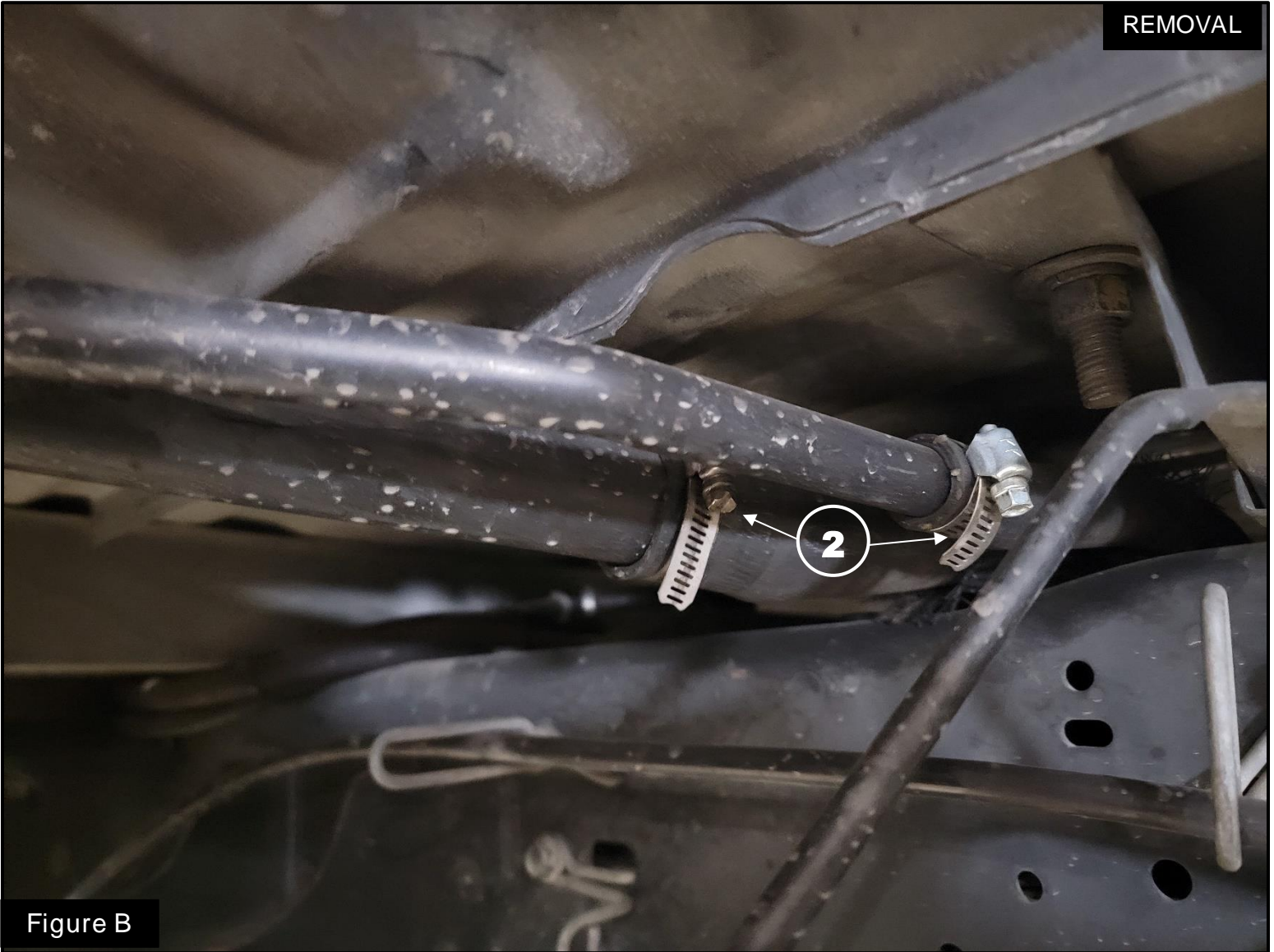

Figure B

Refer to Figure B for Step 2:

Step 2: Disconnect the hose clamps ② from the vent and the filler neck tube.

**Figure C****Refer to Figure C for Step 3:**

NOTE: Removing the driveshaft is not required but it will allow you more working room to install the fuel tank.

Step 3: Support the driveshaft near the center support bearing. Remove the two (2) bolts (3) from the center support bearing and allow the driveshaft to hang.

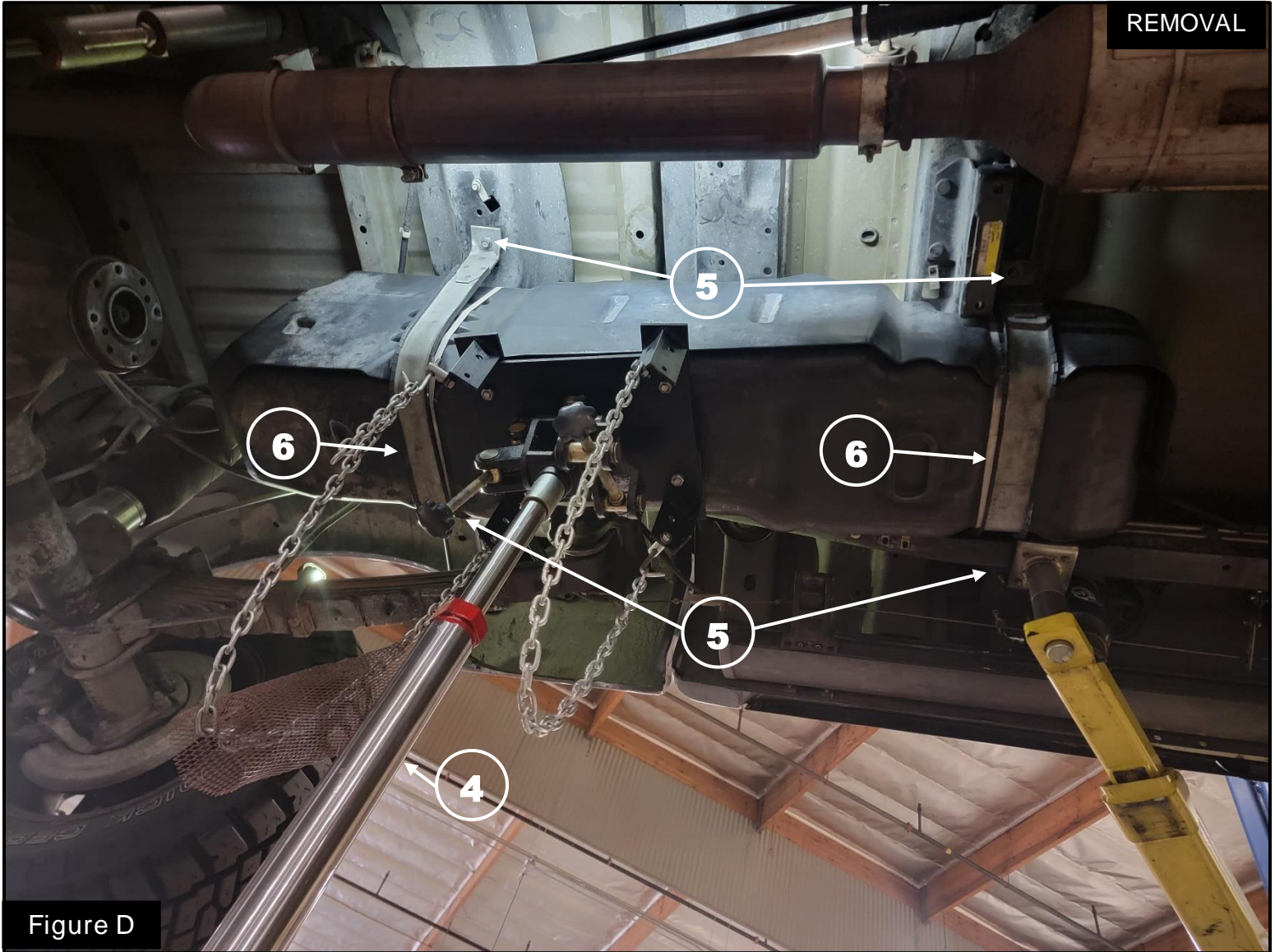

Figure D

Refer to Figure D for Steps 4-5:

Step 4: Support the fuel tank with a jack. (4)

Step 5: Remove the four (4) factory fuel tank straps bolts. (5) Remove the two (2) factory fuel tank straps (6) from the vehicle.

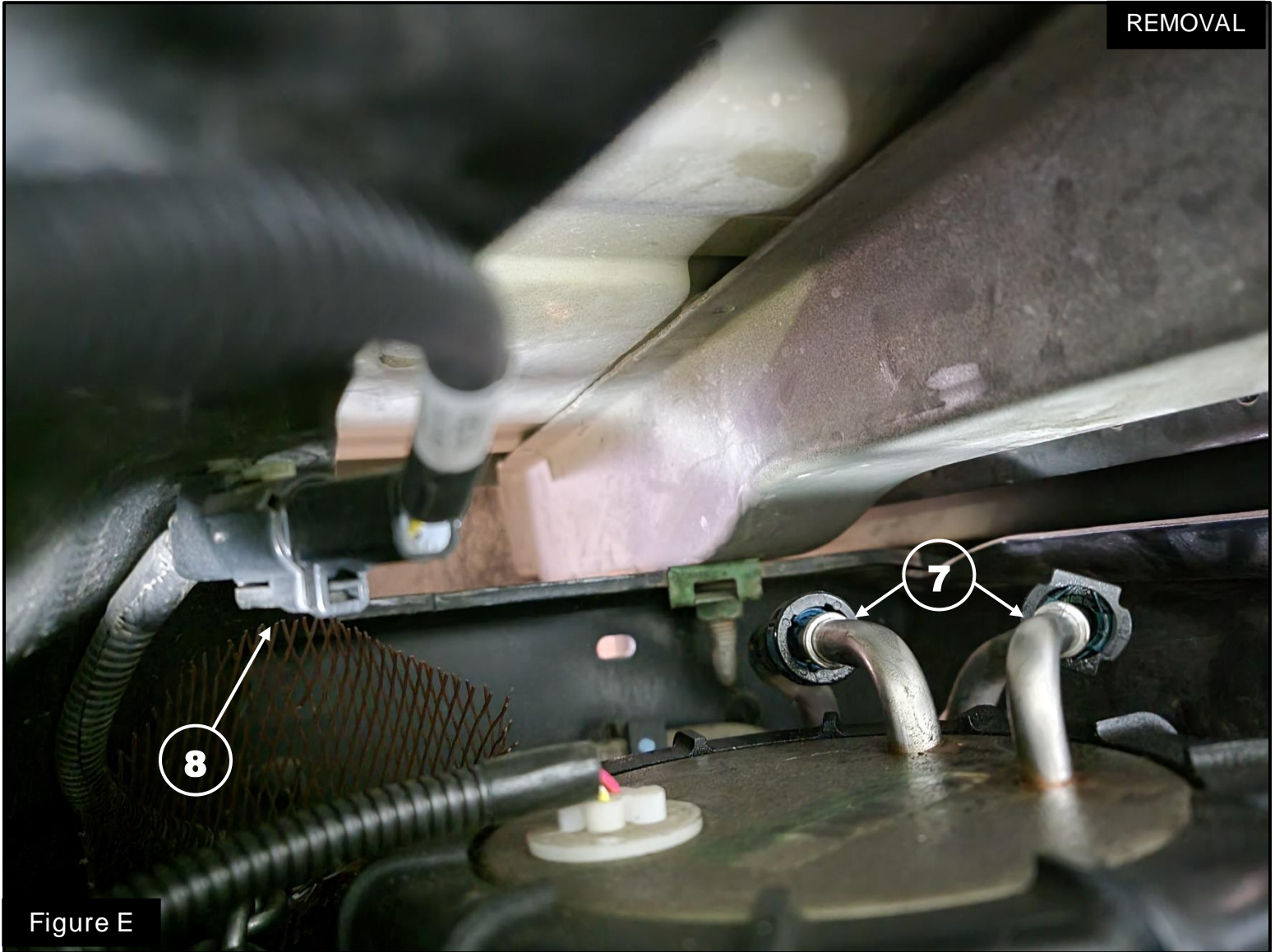

Figure E

Refer to Figure E for Steps 6-8:

NOTE: When lowering the tank, only lower the tank enough for you to disconnect the fuel lines and electrical connector. Be careful not to go too low and kink the factory fuel lines.

Step 6: Lower the tank down slightly.

Step 7: Disconnect the supply and return fuel line. (7)

Step 8: Disconnect the electrical connector for the fuel sender. (8)



Refer to Figure F for Step 9:

Step 9: Disconnect the factory breather hoses (9) on the top of the fuel tank. One is located in the middle of the tank, and one is located at the rear of the tank.

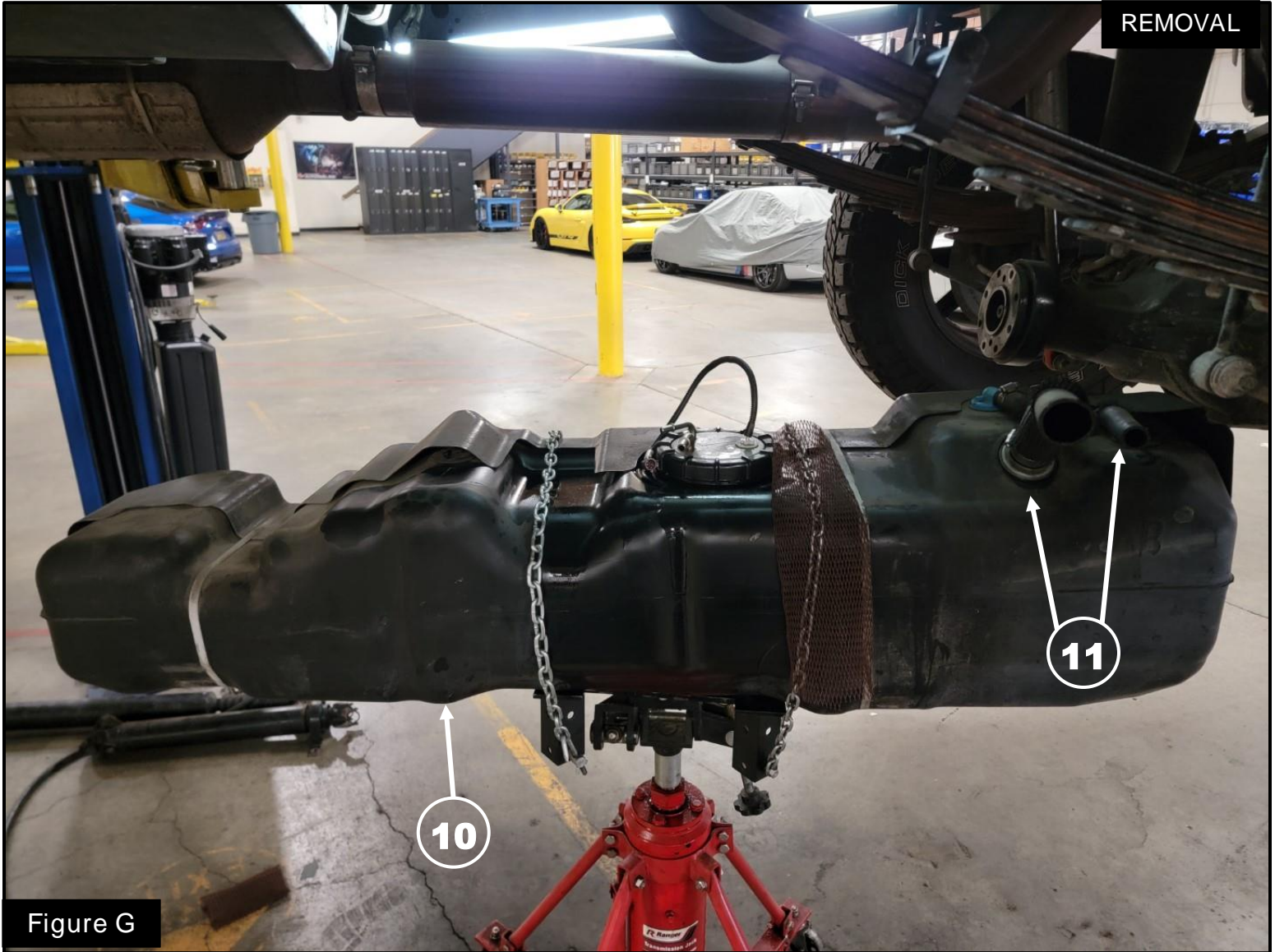

Refer to Figure G for Steps 10-11:

Step 10: Lower the tank (10) from the truck.

Step 11: Remove the fill hose and the vent hose (11) from the factory fuel tank. Save the hose clamps and the hoses for reinstallation.

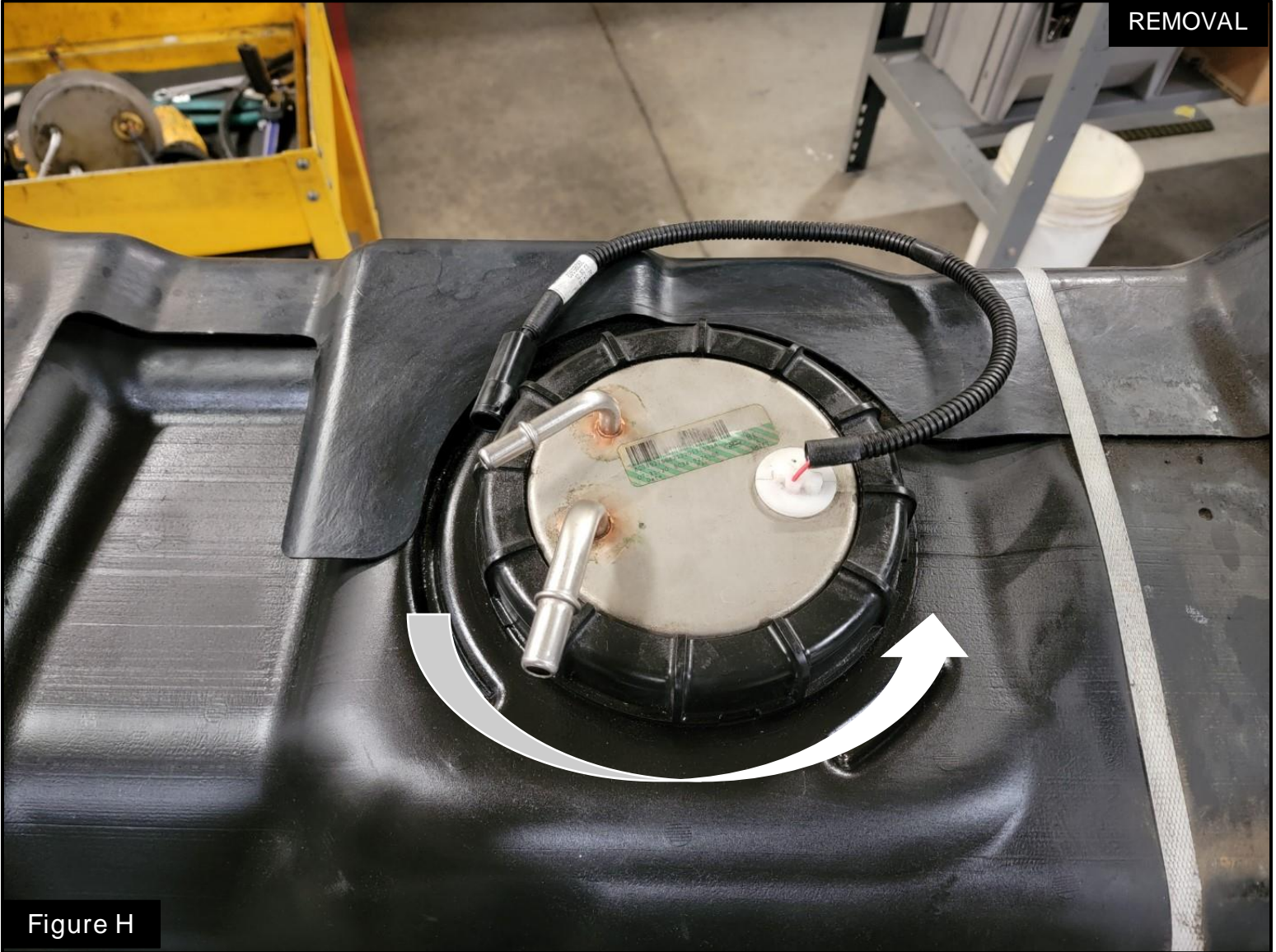
**Figure H****Refer to Figure H for Step 12:**

NOTE: Make sure to clean the top of the tank prior to removing the nut and the sender to prevent dirt from getting into the tank.

NOTE: Make sure to take note of the position that the fuel sender is removed. It will need to go back into the aFe fuel tank the same way.

Step 12: Remove the factory fuel sender from the factory fuel tank by unscrewing the retaining nut. Remove it by using the tool designed for it or by using a chisel and a hammer to unscrew it. Save the factory fuel sender for reinstallation.

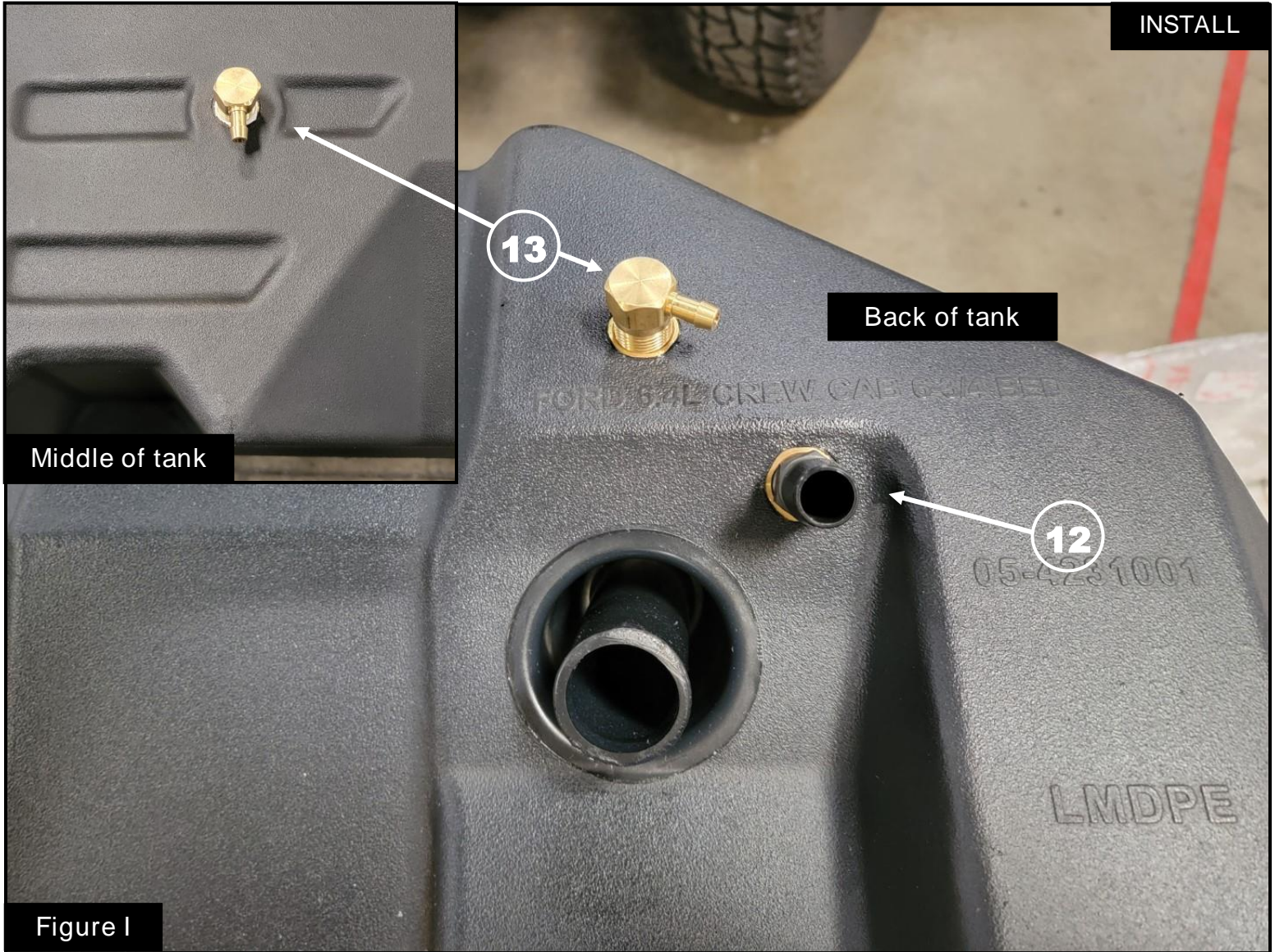
**Figure I**

Refer to Figure I for Steps 13-16:

Step 13: Place the aFe Fuel Tank on a working surface.

Step 14: Prepare the two (2) supplied roll over valves and the supplied vent tube fitting with thread sealant w/ PTFE.

Step 15: Install the vent tube fitting (12) into the aFe fuel tank.

Step 16: Install one (1) rollover valve (13) into the aFe fuel tank behind the fill tube and install one (1) rollover valve (13) into the middle of the tank.

NOTE: Make sure to install the fittings the way they are facing in the images.

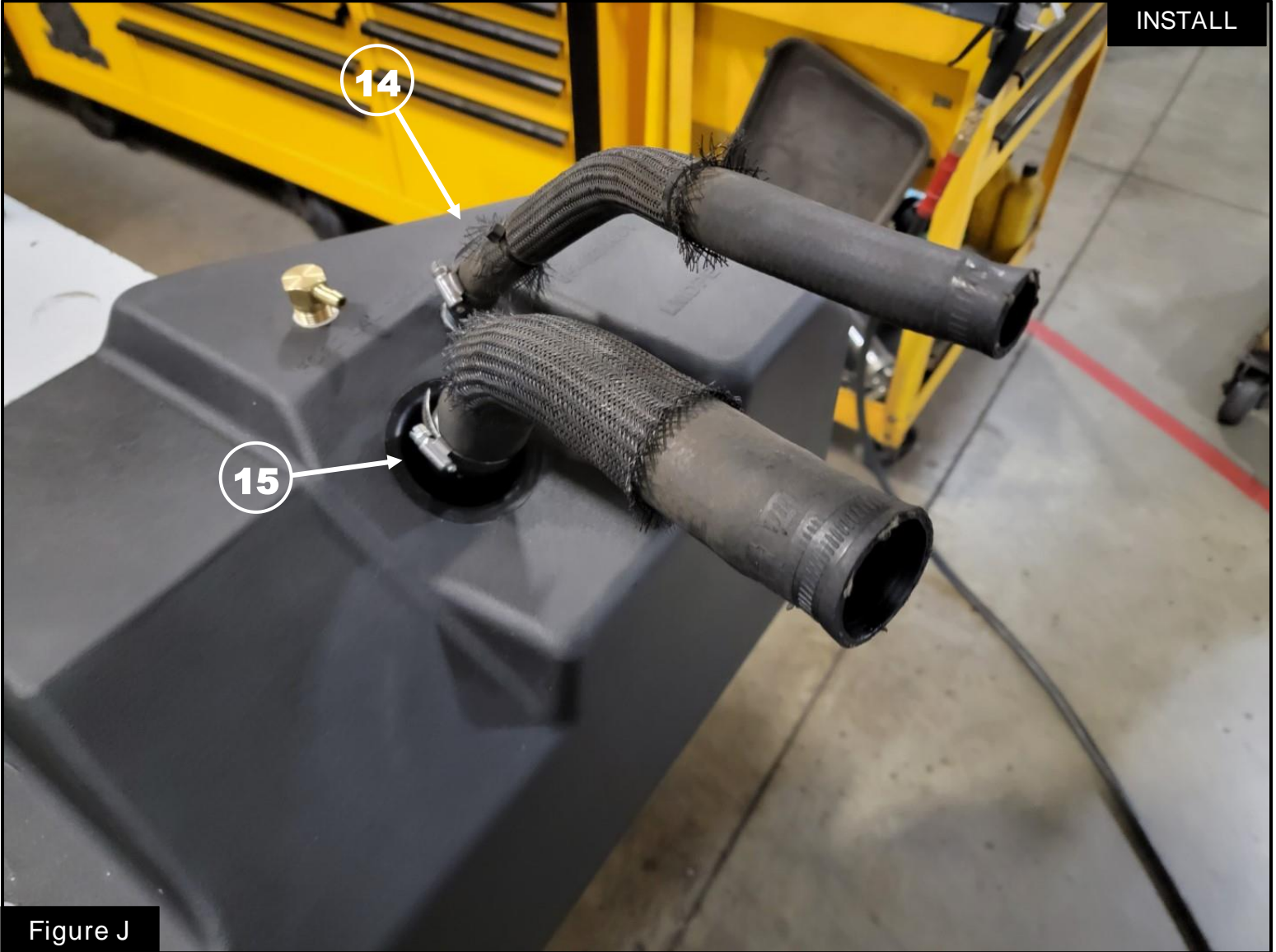

Figure J

Refer to Figure J for Steps 17-18:

Step 17: Install the factory filler hose onto the aFe Fuel Tank. Tighten the hose clamp. ⑭

Step 18: Install the factory vent hose onto the aFe Fuel Tank. Tighten the hose clamp. ⑮

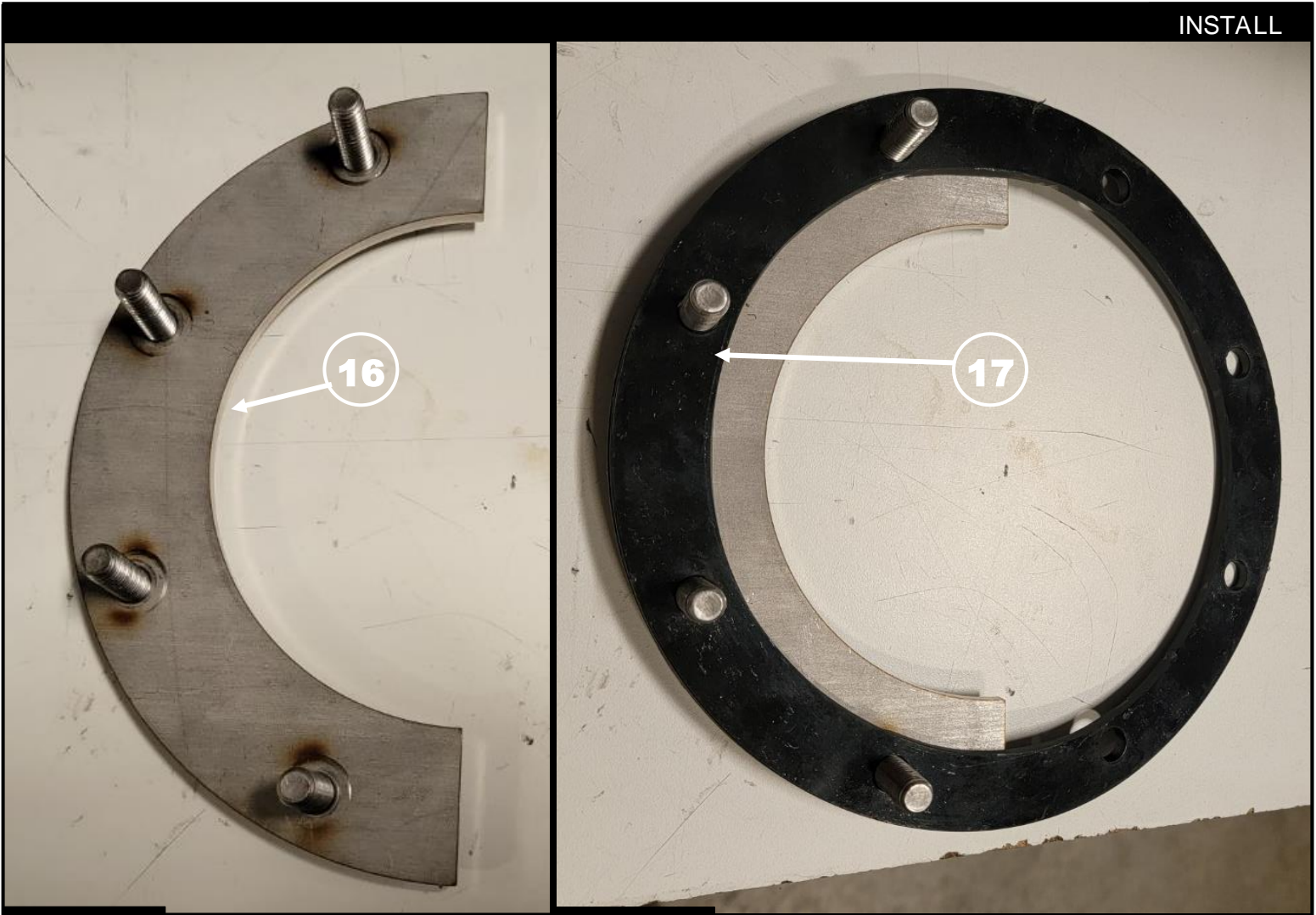

Figure K

Figure L

Refer to Figure K and Figure L for Steps 19-20:

Step 19: Locate one (1) supplied inner fuel sender locking ring. ①⑥

Step 20: Install the supplied fuel tank seal gasket ①⑦ onto the fuel sender locking ring.

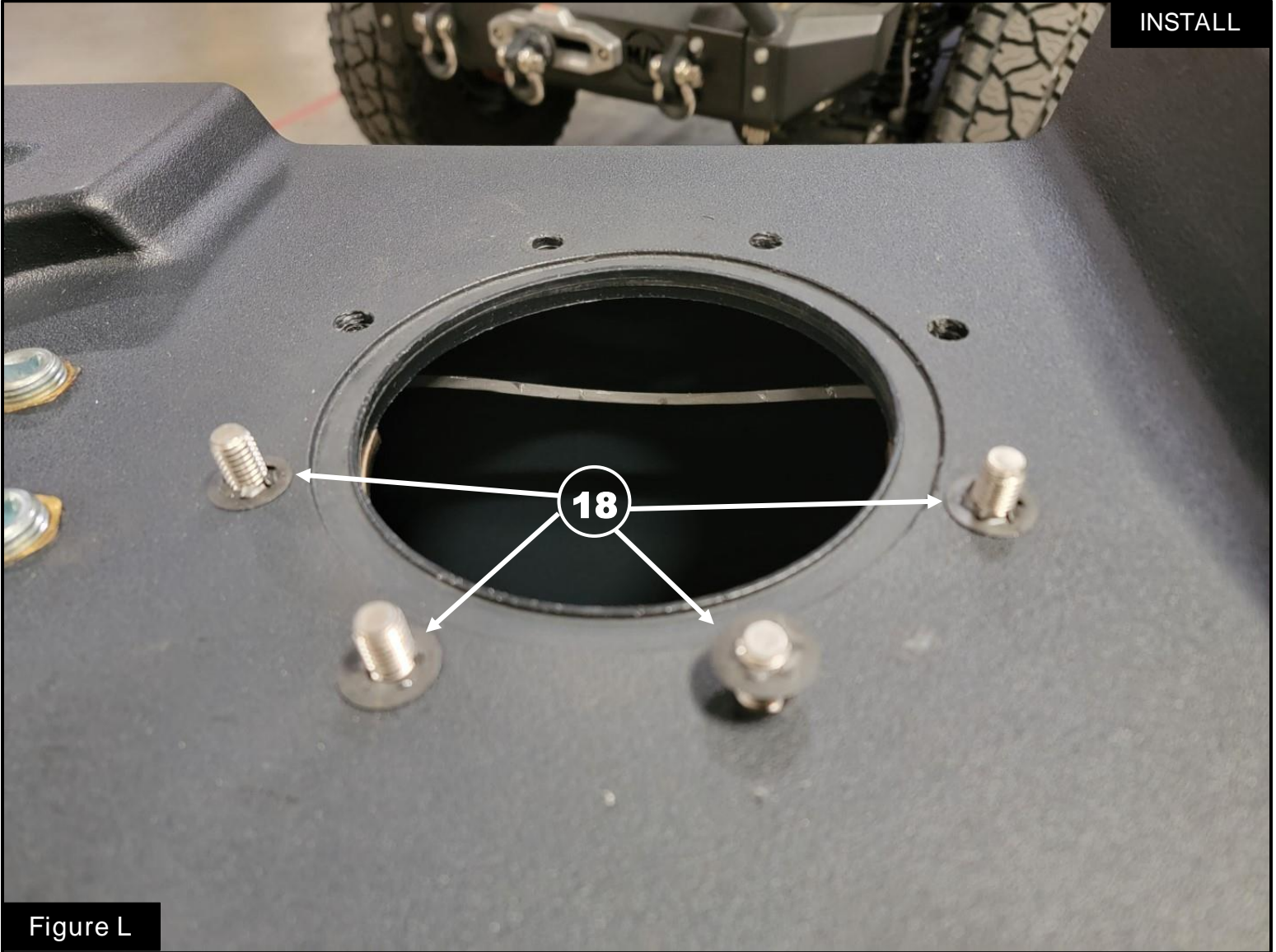

Figure L

Refer to Figure L for Steps 21-22:

Step 21: Install the assembled fuel tank seal gasket and inner fuel sender locking ring into the aFe Fuel Tank.

Step 22: Install four (4) supplied 3/8" round push nuts (18) over the studs.

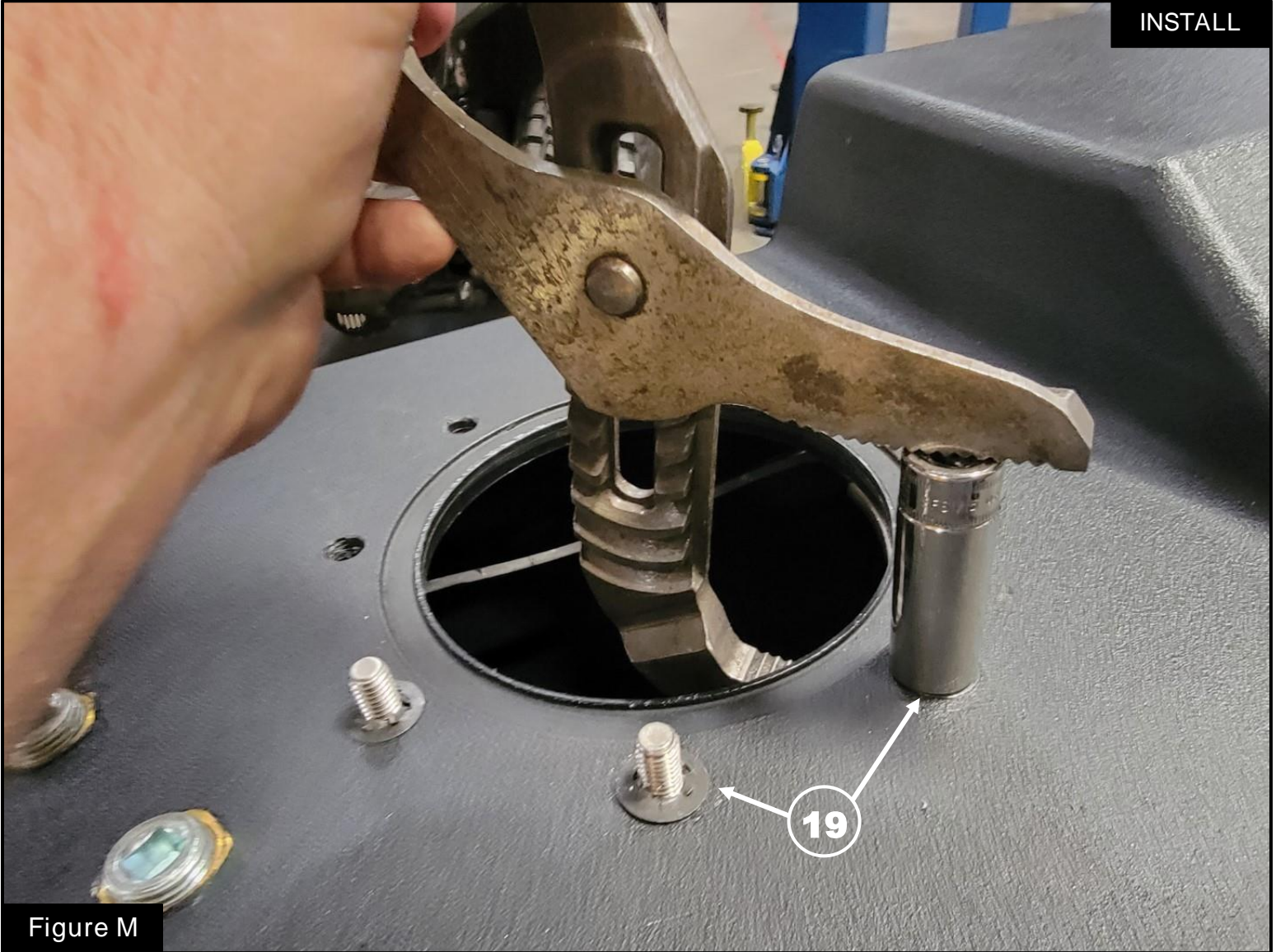

Figure M

Refer to Figure M for Step 23:

Step 23: Using a deep 14mm socket and a pair of channel locks, Tighten the push nuts (19) on the 3/8" studs.

**Figure N**

Refer to Figure N for Steps 24-25:

Step 24: Install the second inner fuel sender locking ring through the fuel tank seal gasket (already installed).

Step 25: Install the four (4) supplied 3/8" round push nuts (20) onto the second inner fuel sender locking ring 3/8" studs and tighten.



Refer to Figure O for Step 26:

Step 26: Lubricate the oring (21) using a light oil and install onto the groove in the top of the fuel tank.

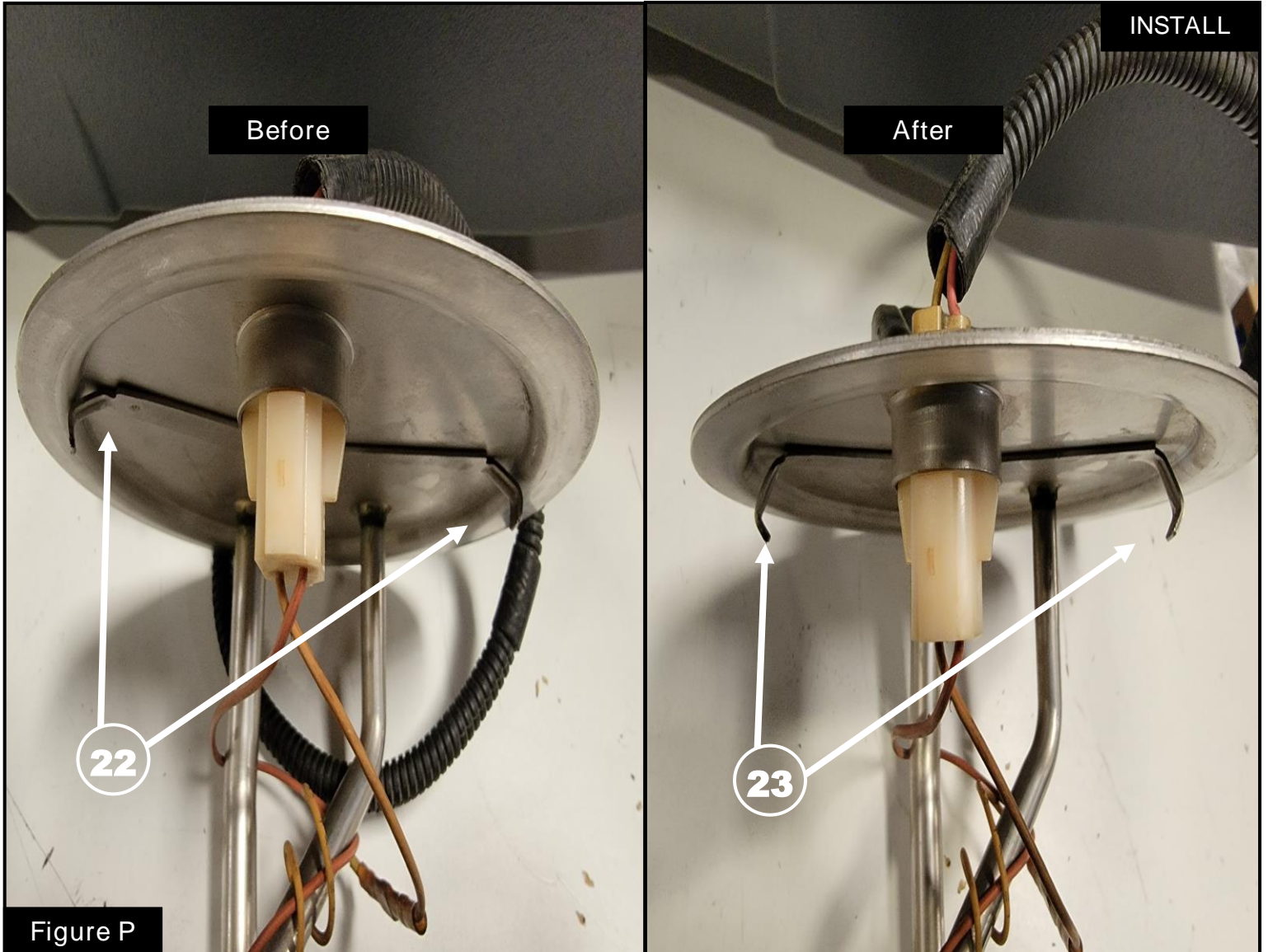

Refer to Figure P for Step 27:

NOTE: This step will require that you bend the locating tabs on the factory sending unit. Please be careful when altering the sending unit. Do not bend the arm holding the float.

Step 27: Notice the locating tabs under the top of the fuel sender. (22) Bend down towards the center of the fuel sender. (23)

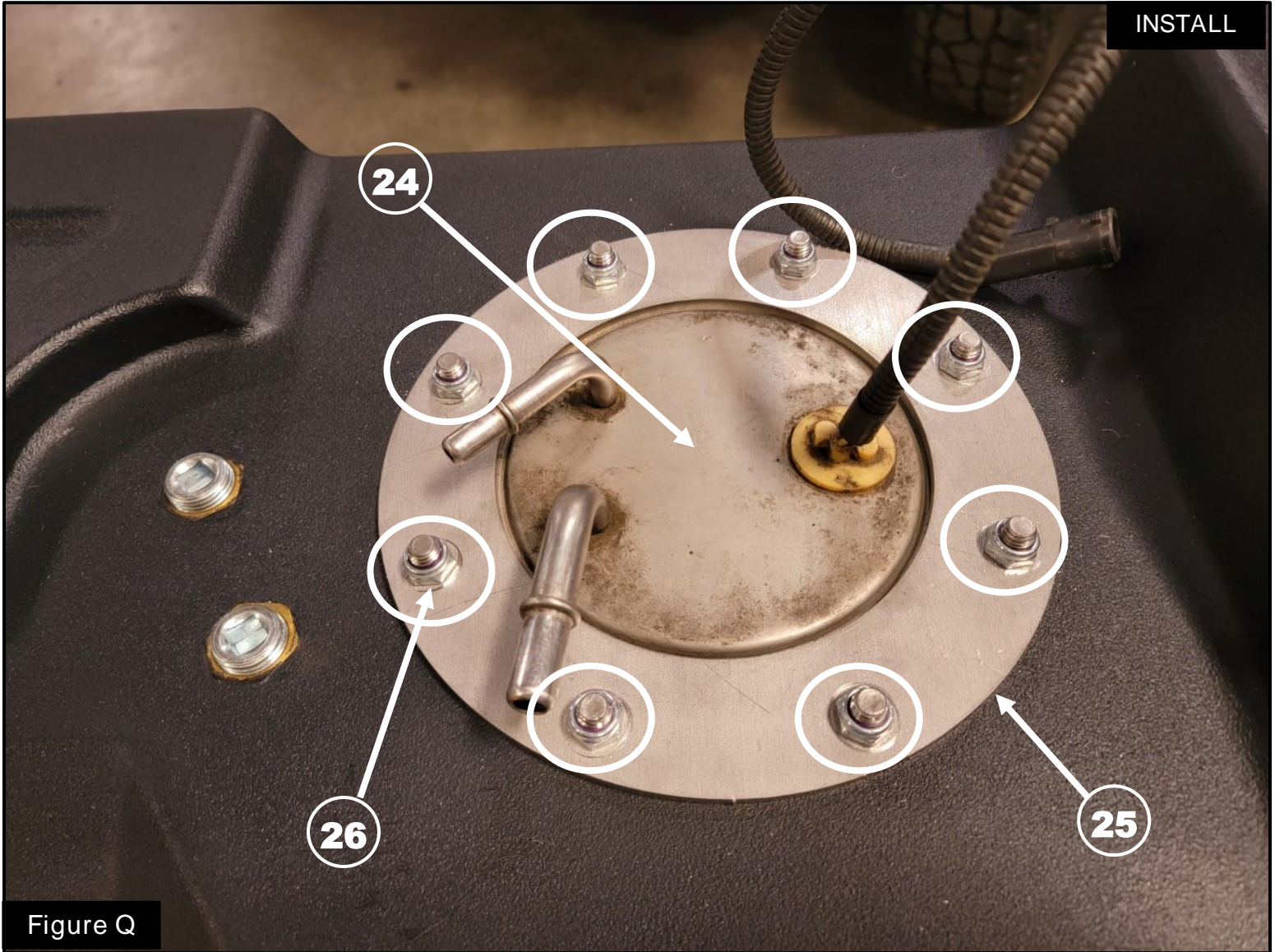
**Figure Q****Refer to Figure Q for Steps 28-31:**

Step 28: Install the factory sending unit (24) into the tank.

Step 29: Place the supplied outer fuel sender locking ring (25) onto the bolts rising thru the fuel tank.

Step 30: Place the eight (8) 3/8" nylon nuts (26) onto the studs and tighten to 10 lbs. ft.

Step 31: Go around again and tighten the eight (8) 3/8" nylon nuts (26) to 20 lbs. ft.

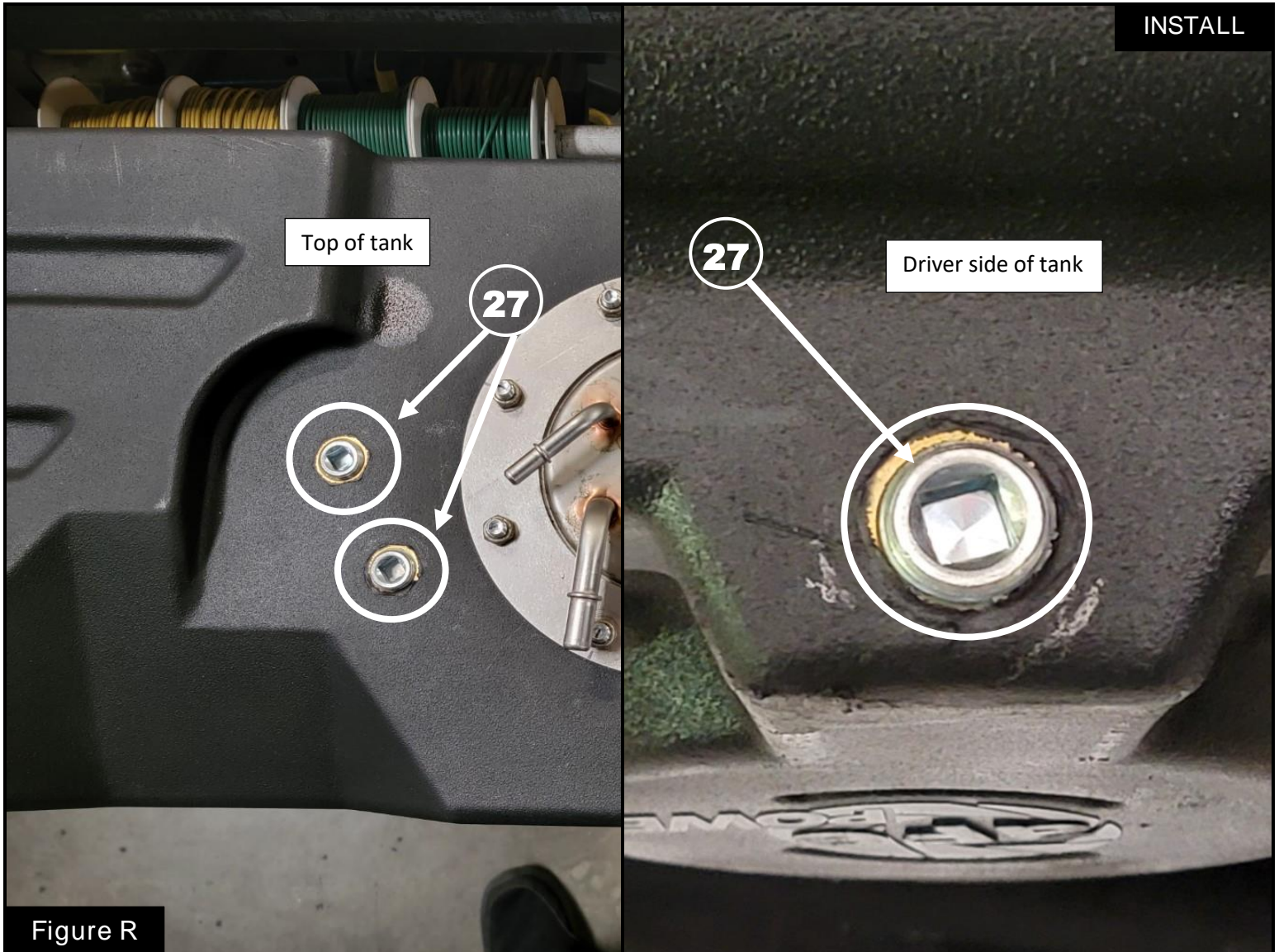

Refer to Figure R for Step 32:

NOTE: If using alternate ways of sending the fuel to the engine, the ports will need to be opened up by using a dremel tool or drill bits. Be careful when opening up a port so **that you don't hurt** the threads. Make sure to use sealant on any plug installed into the ports and clean the tank before use.

Step 32: Install the three (3) supplied 1/2" npt plugs (27) into the ports to protect the threads from debris when not in use.



Refer to Figure S for Steps 33-34:

Step 33: Remove the factory spring nut (28) from the factory fuel tank strap.

Step 34: Install the factory spring nut (29) onto the supplied aFe front fuel tank strap.



Figure T

Refer to Figure T for Steps 35-36:

Step 35: Remove the factory rubber fuel hose from the factory vent tube in the middle of the truck.

Step 36: Install the 4" 5/16" fuel hose (30) onto the vent tube fitting.



Figure U

Refer to Figure U for Steps 37-38:

Step 37: Remove the factory rubber fuel hose from the factory vent tube in the rear of the truck.

Step 38: Install the 21" 5/16" fuel hose (31) onto the vent tube fitting.

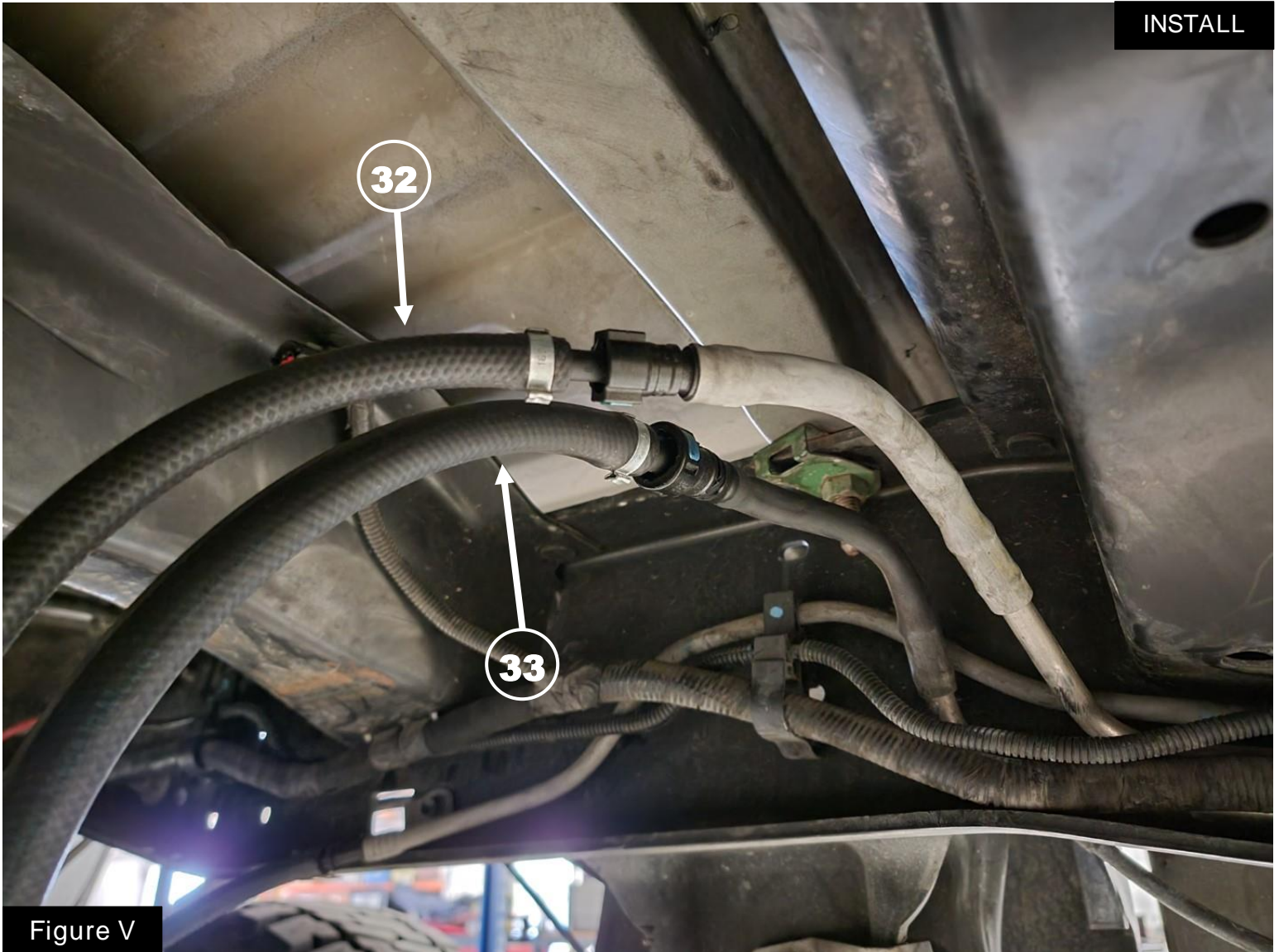

Figure V

Refer to Figure V for Steps 39-40:

NOTE: Install the extension hoses if they are required. Some of the vehicles will not need them.

Step 39: Install the 1/2" extension hose (32) into the factory supply line.

Step 40: Install the 3/8" extension hose (33) into the factory return line.

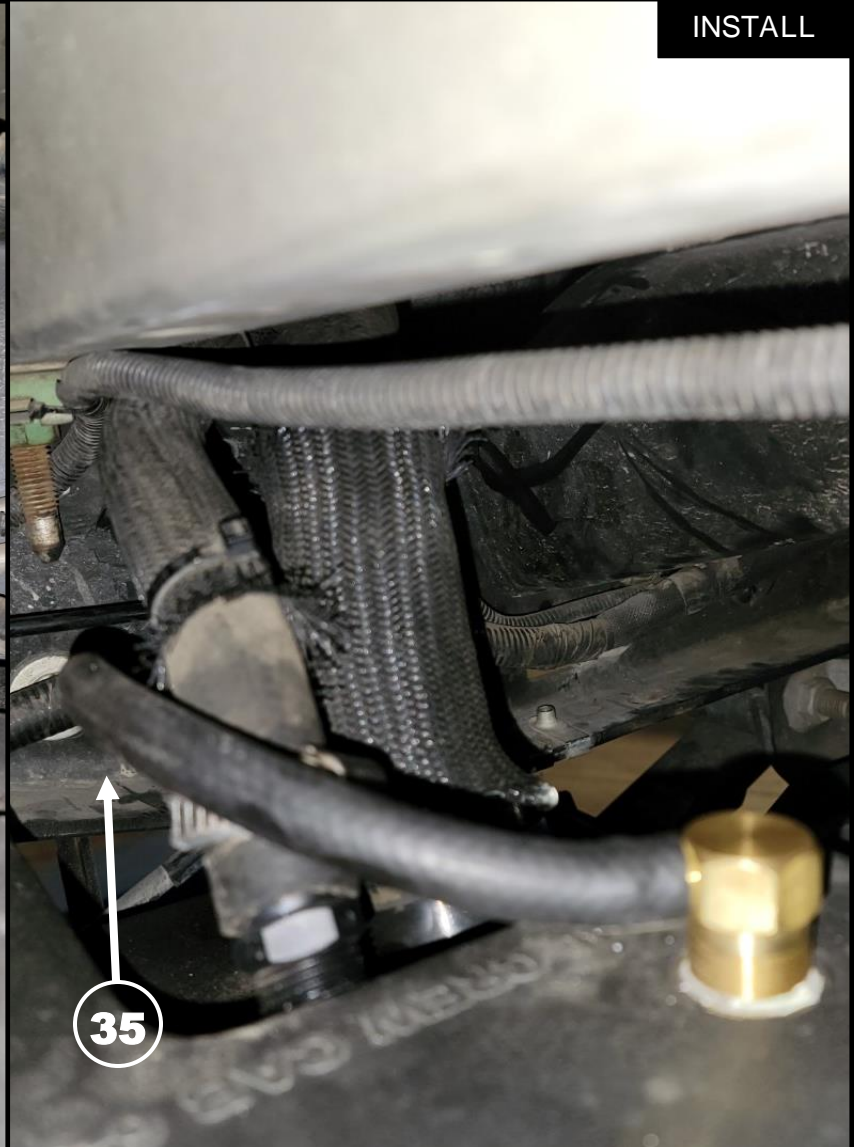
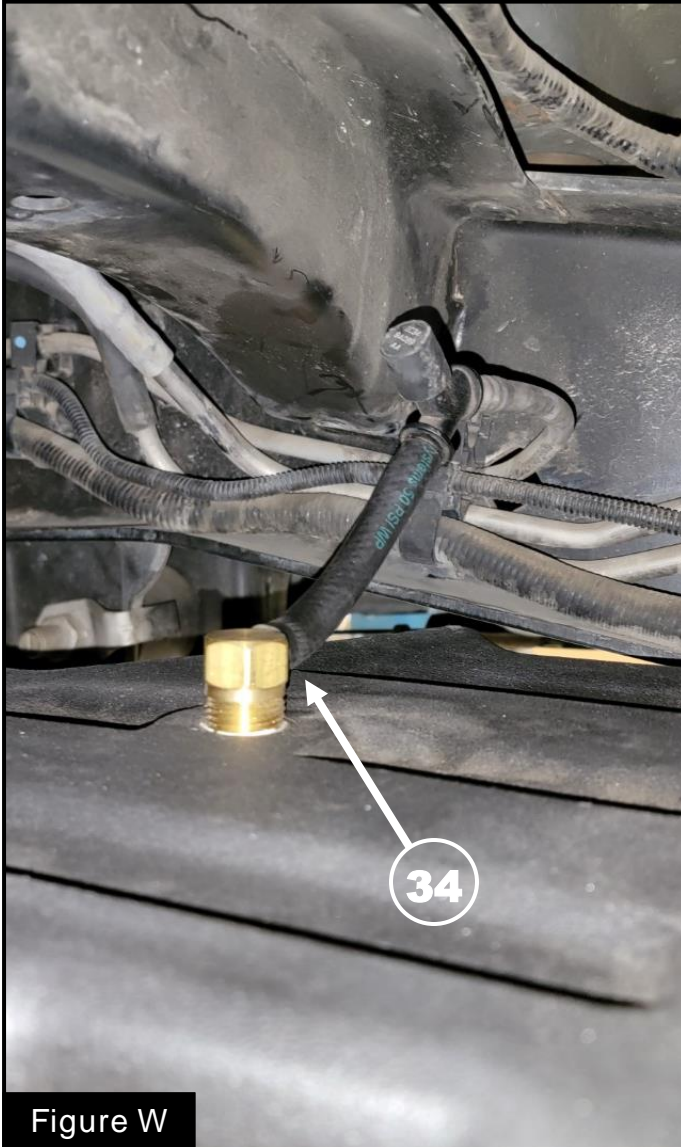

Figure W

Refer to Figure W for Steps 41-44:

Step 41: Place the aFe Fuel Tank on the lifting device being used to lift it back into the truck.

Step 42: Leave yourself some room to work and connect the hoses.

Step 43: Place the mid tank 5/16" fuel hose onto the roll over valve. (34)

Step 44: Place the back tank 5/16" fuel hose onto the rollover valve near the rear of the tank. (35)

Route the back vent line around the fill hose and the breather hose.

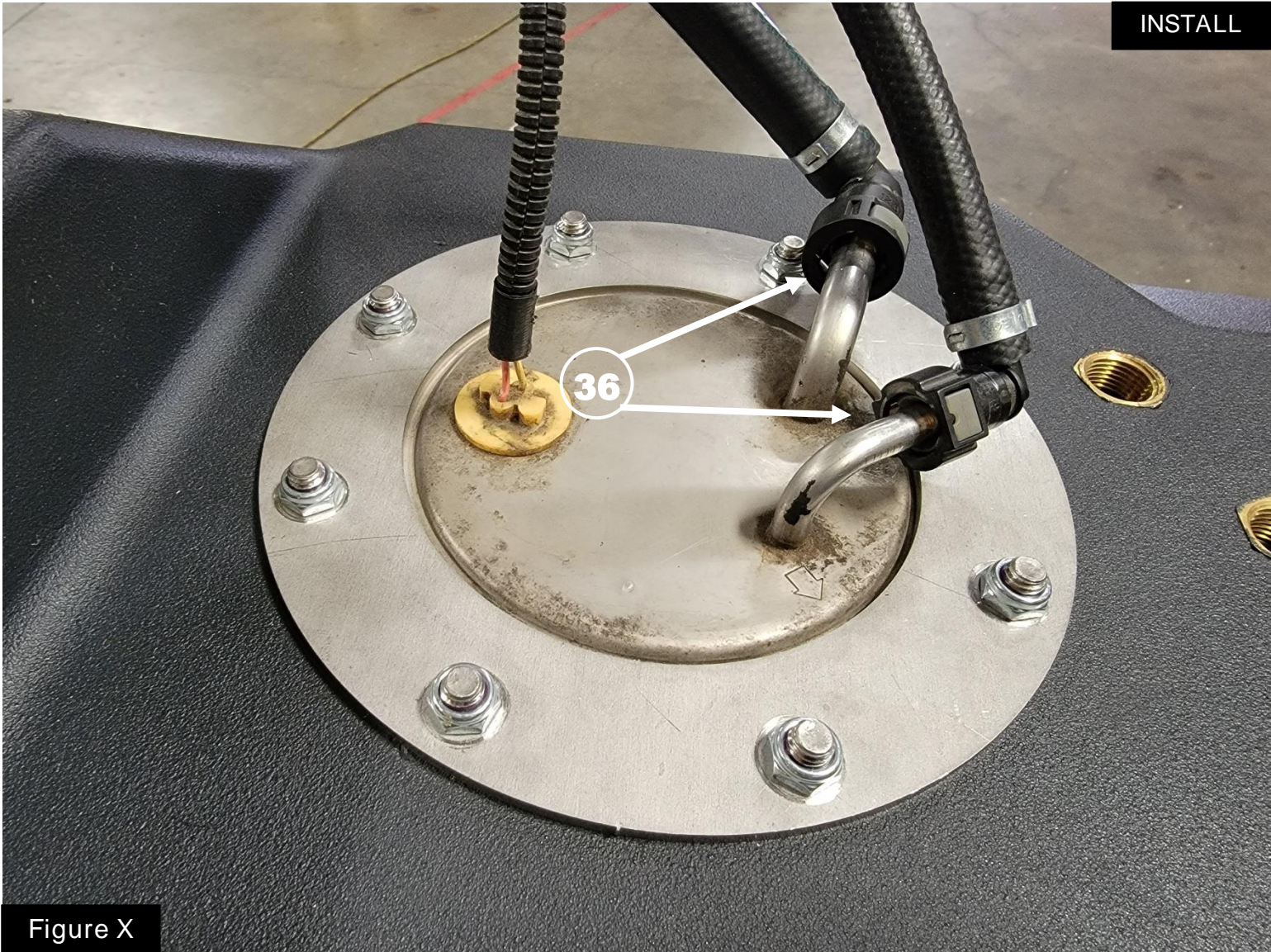

Figure X

Refer to Figure X for Step 45:

Step 45: Connect the supply and return lines **36** to the fuel tank.



Figure Y

Shown without fuel tank in picture

Refer to Figure Y for Step 46:

Step 46: Reconnect the electrical connector (37) for the fuel sender.

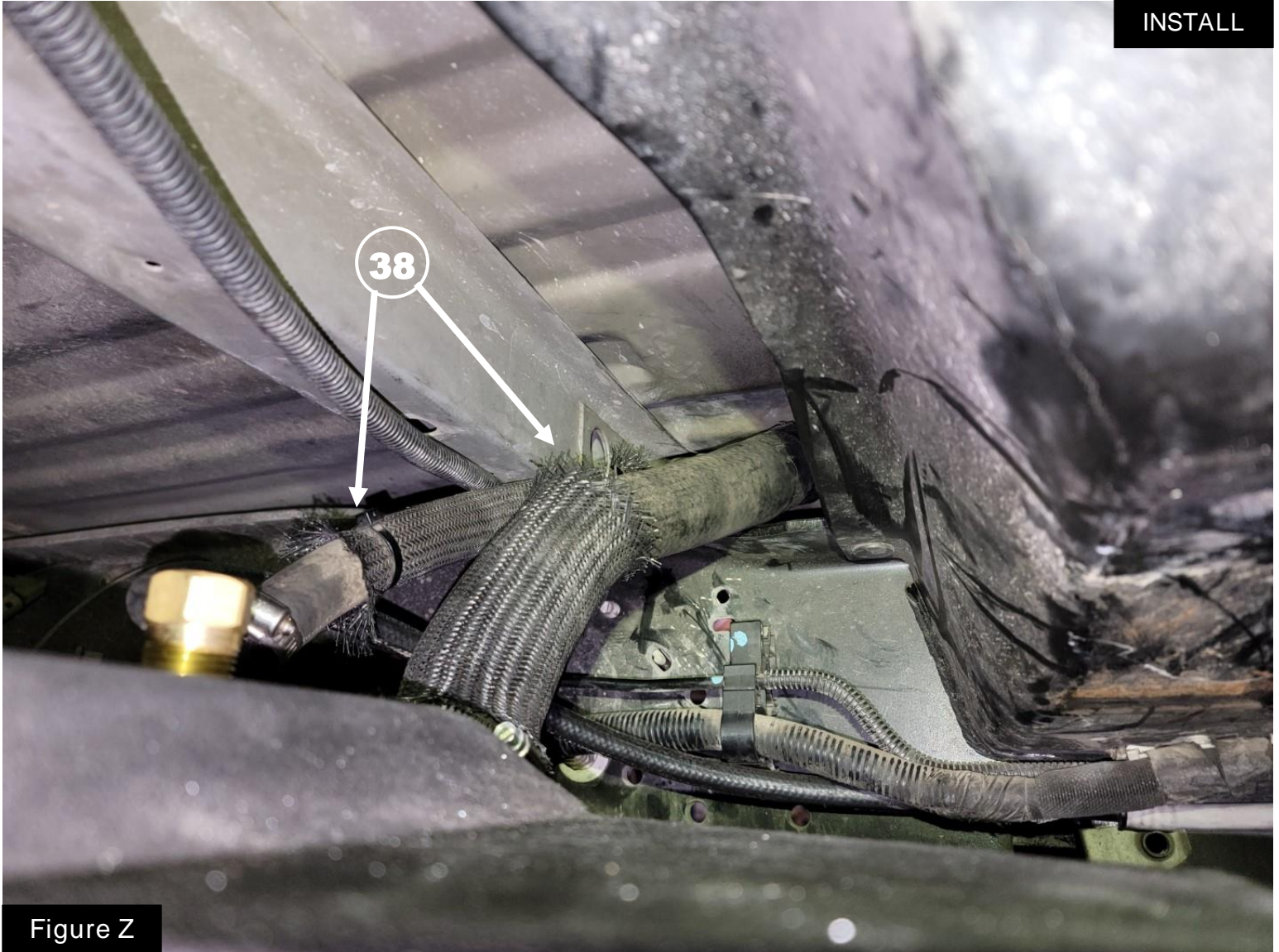

Figure Z

Refer to Figure Z for Step 47:

Step 47: As the tank is going back into place, make sure the fill hose and the vent hose (38) go back into the factory location over the frame rail.

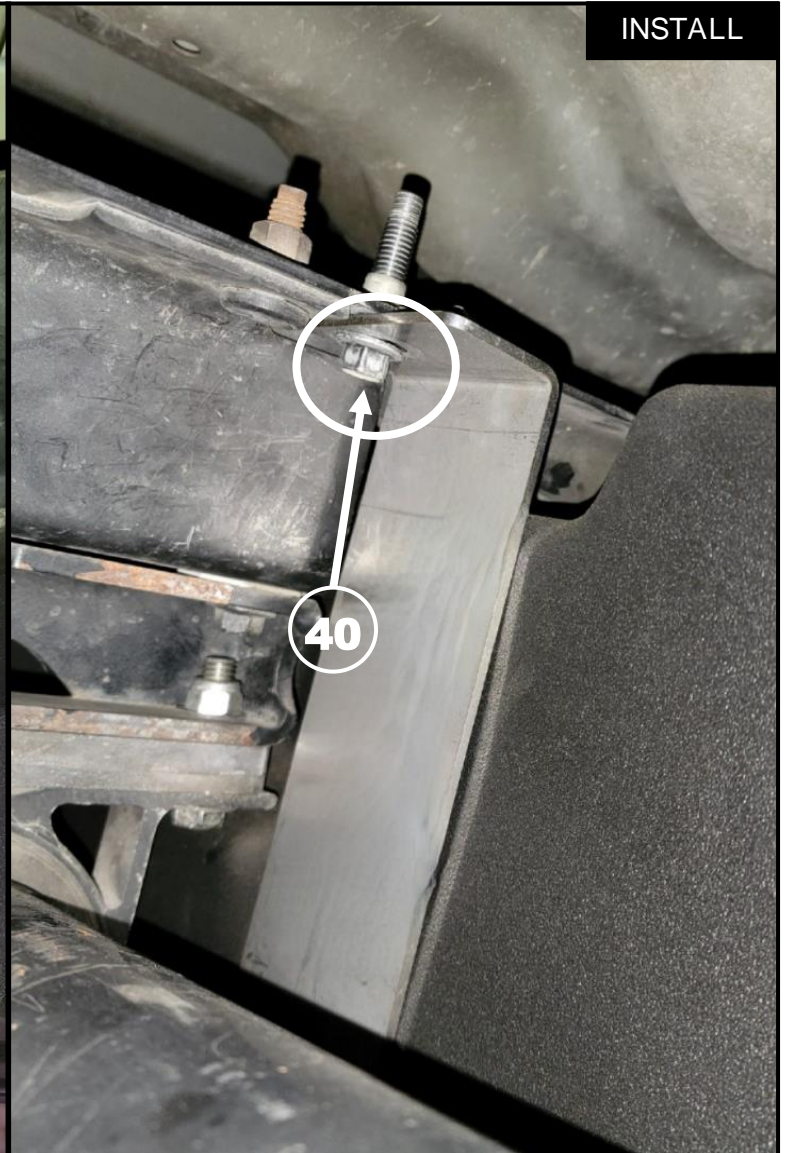
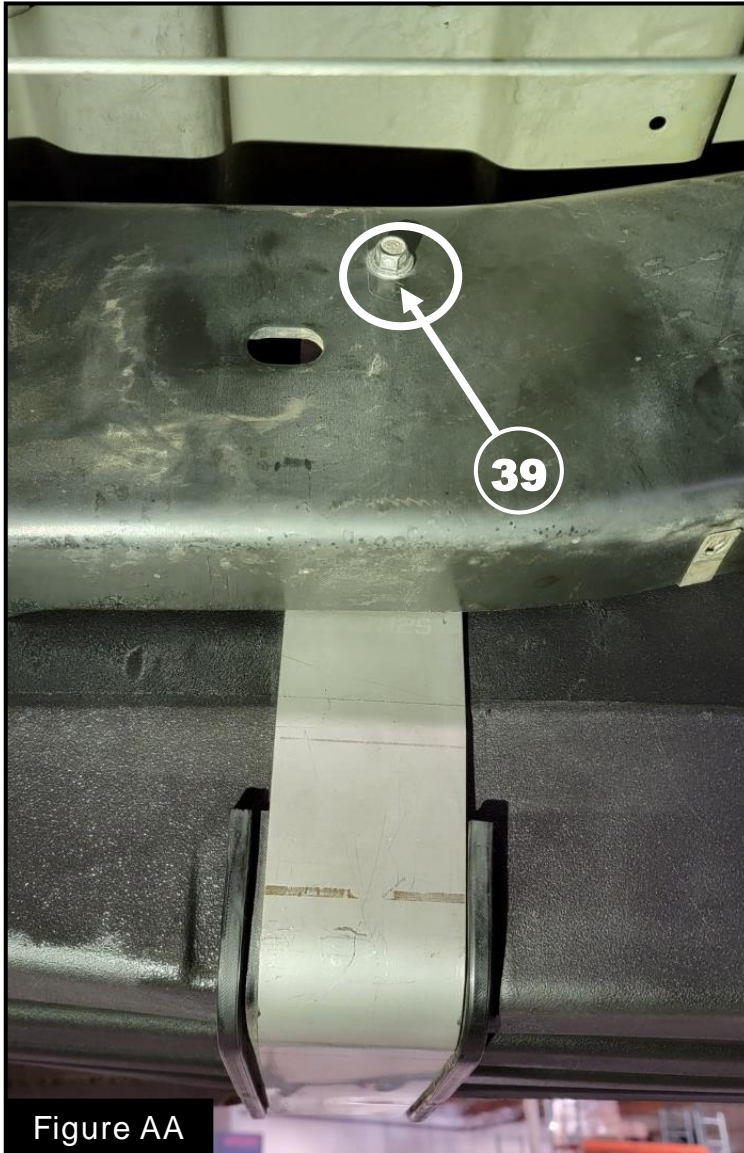

Figure AA

Refer to Figure AA for Steps 48-50:

Step 48: Carefully lift the tank all the way to the till it hits the frame cross braces of the frame rail.

Step 49: Install the supplied front fuel tank strap and the one (1) supplied fuel tank insulator in the front factory tank strap location.

Step 50: Using the factory hardware, install the bolt (39) on the outside of the driver side frame rail to the front fuel tank strap. Then install the bolt (40) located in the middle of the truck near the center support bearing. Make sure the fuel tank strap and the fuel tank strap insulator are centered on the marks located on the tank.

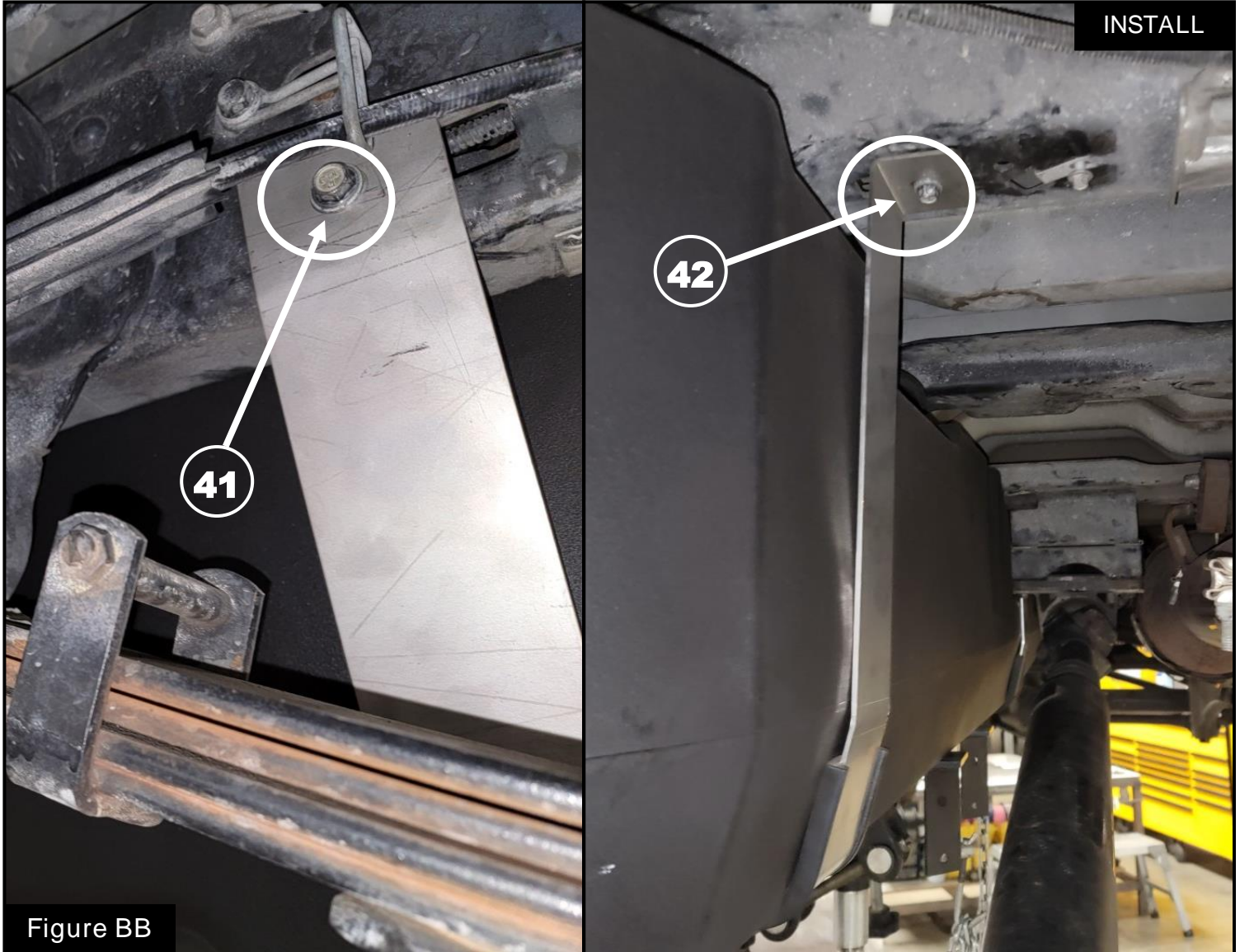

Figure BB

Refer to Figure BB for Steps 51-53:

Step 51: Install the supplied rear fuel tank strap and the one (1) supplied fuel tank insulator in the rear factory tank strap location.

Step 52: Using the factory hardware, install the bolt (41) on the outside of the driver side frame rail to the rear fuel tank strap. Then install the bolt (42) located in the middle of the truck near the rear of the vehicle. Make sure the fuel tank strap and the fuel tank strap insulator are centered on the marks located on the tank.

Step 53: When all the fuel tank straps and are located on the fuel tank in the correct location, tighten the hardware.



Figure CC

Refer to Figure CC for Step 54:

Step 54: Reinstall the hardware removed from the center support bearing and the driveshaft (43) and tighten (if applicable).



Figure DD

Refer to Figure DD for Steps 55-56:

Step 55: Install the fill hose onto the fill tube and tighten using the factory hose clamp. ④④

Step 56: Install the vent hose onto the vent tube and tighten using the factory hose clamp. ④⑤



Figure EE

Refer to Figure EE for Steps 57-58:

Step 57: Check all the components are tight and secure.

Step 58: Fill the fuel tank. Check for leaks while you are filling it up.

Step 59: Your installation is now complete. Thank you for choosing aFe POWER!



Page left blank intentionally



advanced FLOW engineering, inc.

252 Granite Street Corona, CA 92879
TEL: 951.493.7100 • TECH: 951.493.7134
E-Mail: Tech@aFepower.com