

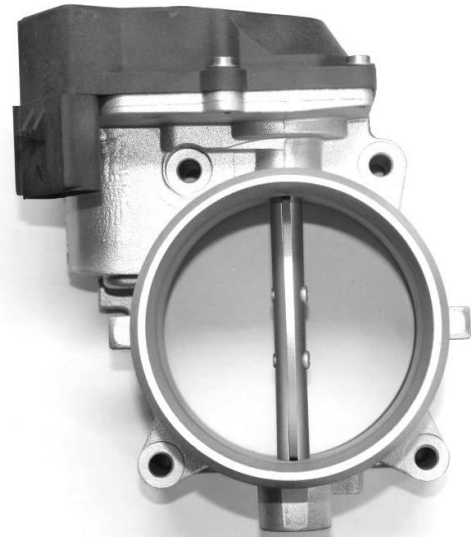

**DOWNLOAD THE LATEST
INSTALL MANUALS AT
www.bddiesel.com**



ELECTRONIC POSITIVE AIR SHUTOFF

1036750	2007-2009 Dodge 6.7L
1036751	2010-2018 Dodge 6.7L
1036753	2019-2024 Dodge 6.7L
1036754	2008-2010 Ford 6.4L
1036755	2011-2019 Ford 6.7L
1036757	2020-2024 Ford 6.7L
1036756	2018-2021 Ford 3.0L
1036758	2008-2010 GMC 6.6L (LMM/LGH)
1036759	2011-2016 GMC 6.6L* (LML)
1036760	2016-2021 GMC 2.8L (LWN)
1036761	2017-2022 GMC 6.6L (L5P)
1036762	2019-2023 GM 3.0L (LM2/LZ0)
1036763	2014-2023 Dodge 3.0L

*2011-2015 Savana/Express vans use 1036758



KIT CONTENTS



Please check to make sure that you have all the parts listed in this kit **before** you start the disassembly of your truck.

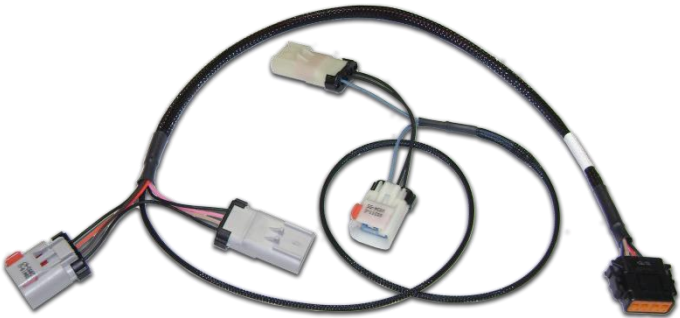
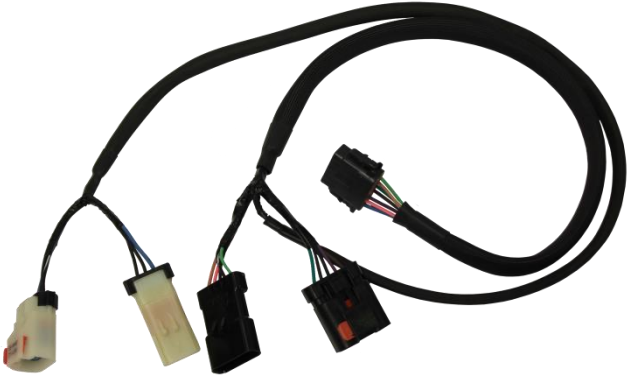

<p align="center">1306731</p>	<p align="center">1306733</p>
	
<p><i>Electronic Module for kits: 1036750, 1036751, 1036753, 1036754, 1036755, 1036757, 1036756, 1036758, 1036759, 1036760, 1036761, 1036762</i></p>	<p><i>Electronic Module for kit 1036763</i></p>
<p align="center">Qty: 1</p>	<p align="center">Qty: 1</p>
<p align="center">1302380</p>	<p align="center">1302379</p>
	
<p><i>Switch Harness Included in kits: 1036750, 1036751, 1036753, 1036754, 1036755, 1036757, 1036756, 1036758, 1036759, 1036760, 1036761, 1036763</i></p>	<p><i>Switch Harness Included in kits: 1036762</i></p>
<p align="center">Qty: 1</p>	<p align="center">Qty: 1</p>



1302251	1306790	1302250-RG	2000108
			
<i>Switch Decal</i>	<i>Switch Guard Decal</i>	<i>Switch Guard</i>	<i>Switch Bracket</i>
Qty: 1	Qty: 1	Qty: 1	Qty: 1
1330052	1300131	FT-10910-03116	1006701
			
<i>Bracket Screws</i>	<i>Cable Tie</i>	<i>Velcro strips (4")</i>	<i>Window Decal</i>
Qty: 2	Qty: 12	Qty: 2 pcs	Qty: 1



1036750	1036751
1302381	1302382
	
<i>Dodge 2007-09 6.7L Harness</i>	<i>Dodge 2010-18 6.7L Harness</i>
Qty: 1	Qty: 1

1036753	1036754
1302384	1302388
	
<i>Dodge 2019-24 6.7L Harness</i> Qty: 1	<i>Ford 2008-10 6.4L Harness</i> Qty: 1

1036755	1036756
1302389	1302391
	
<i>Ford 2011-19 6.7L Harness</i> Qty: 1	<i>Ford 2018-21 3.0L Harness</i> Qty: 1

1036757	1036758
1302392	1302385
	
<i>Ford 2020-24 6.7L Harness</i>	<i>GM 2008-10 6.6L Harness</i>
Qty: 1	Qty: 1

1036759	1036760
1302386	1302387
	
<i>GM 2011-16 6.6L Harness</i>	<i>GM 2016-22 2.8L Harness</i>
Qty: 1	Qty: 1

<p>1036761</p>	<p>1036762</p>
<p>1302390</p>	<p>1302393</p>
	
<p><i>GM 2017-22 6.6L Harness</i></p>	<p><i>GM 2019-23 3.0L Harness</i></p>
<p>Qty: 1</p>	<p>Qty: 1</p>

<p>1036763</p>	
<p>1302399</p>	
	
<p><i>Dodge 2014-23 3.0L Harness</i></p>	
<p>Qty: 1</p>	

TABLE OF CONTENTS

KIT CONTENTS2

TABLE OF CONTENTS7

Before you start8

Required tools8

Installation9

Intake valve locations9

 2007-2024 Dodge 6.79

 2014-2023 Dodge 3.010

 2008-2010 GMC 6.6.....11

 2011-2016 GMC 6.6.....11

 2016-2022 GMC 2.8L.....12

 2017-2022 GMC 6.6L.....13

 2019-2023 GM 3.0L (LM2/LZ0)14

 2008-2010 Ford 6.4.....15

 2011-2023 Ford 6.7.....15

 2018-2021 Ford 3.0.....16

Crankshaft position sensor locations17

 2007-2022 Dodge 6.717

 2014-2023 Dodge 3.017

 2008-2016 GMC 6.6.....18

 2016-2022 GMC 2.8L.....18

 2019-2023 GM 3.0L (LM2/LZ0)19

 2017-2022 GMC 6.6L.....21

 2008-2010 Ford 6.4.....21

 2011-2023 Ford 6.7.....22

 2018-2021 Ford 3.0.....23

Module Mounting Locations24

 2007-2022 Dodge24

 2008-2022 GMC.....25

 2008-2023 Ford 6.7L.....25

 2018-2021 Ford 3.0L.....26

 2019-2023 GM 3.0L (LM2/LZ0)26

Electronic PAS system operation.....30

Troubleshooting31

Circuit board switch and LED functions.....33

Wiring diagram34

Introduction

Most late model diesel engines incorporate an electronic throttle body into the intake manifold to partially restrict intake air to aid in EGR function and meet ever increasing emission standards. When controlled correctly, this valve can completely shut off the outside air supply to stop the engine. The BD Electronic Positive Air Shutdown kit connects to this valve to shut the engine down in emergency situations.

The BD Electronic PAS will automatically shut off the engine if it exceeds a preset engine RPM or if toggled manually with the supplied switch. The BD module also has an automatic reset feature which will reopen the valve once the engine has stopped. No longer does the operator need to open the hood to reset the valve after a system test.

The BD Electronic PAS is easier to install than previous PAS products as it is completely plug and play with existing parts on the vehicle.

NOTE:

- 2017+ GM 6.6L Duramax WILL set an engine fault code when the E-PAS is triggered. This is normal on this engine with any PAS system on this vehicle. Code should be cleared after a shutdown event but is not harmful.
- 2019+ GM 3.0L Duramax should not set off any code when the EPAS shuts off the engine while idling. At higher RPMs if the EPAS button is pressed then a P122D code is set by the vehicle. Code should be cleared after a shutdown event but is not harmful.

Before you start

Ensure the intake valve on the vehicle will connect to the harness supplied with your kit, the connector may be different based on the year of manufacture of the vehicle and care must be taken to ensure the correct kit is ordered.

Required tools

- Drill
- 1/8" Drill Bit
- 1/2" Unibit
- Battery Terminal Wrench



An Information decal has been provided in this kit. This may allow safety personal and inspector's to quickly identify that your vehicle is equipped with a BD Positive Air Shut Down unit. Install this decal in a visible location on the inside glass of the vehicle.

Installation



VEHICLE SHOULD BE SAFELY SECURED BEFORE INSTALLATION.

1. Locate the intake air valve on the motor and connect the supplied BD PAS wiring harness inline by connecting the BD harness directly to the valve and to the vehicle's original electrical connector.

NOTE: If the vehicle has been re-tuned to no longer utilize the intake air valve and it is currently disconnected, connect the BD harness only to the intake valve and leave the OE connector disconnected.

Intake valve locations

2007-2024 Dodge 6.7

Intake horn, pointing downwards on the driver side of the engine. The electrical connector is on the bottom of the valve. 2007-2009 have a 4-pin gray connector; 2010+ have a 5-pin black connector.



2014-2023 Dodge 3.0

Center top of engine on lower side of intake valve. Remove plastic engine cover, remove the charge air hose (spring clip), remove charge air hose adapter (4 x 8mm bolts) and move out of the way. The connector is orange colored.

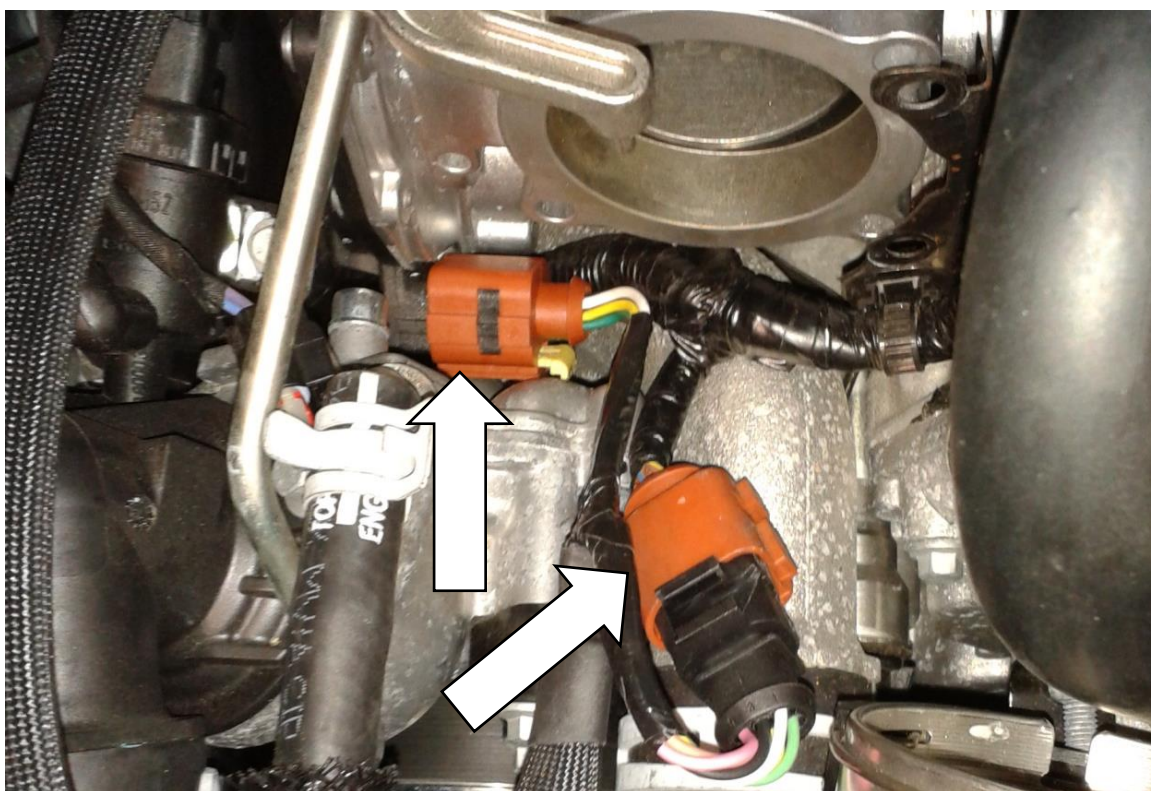
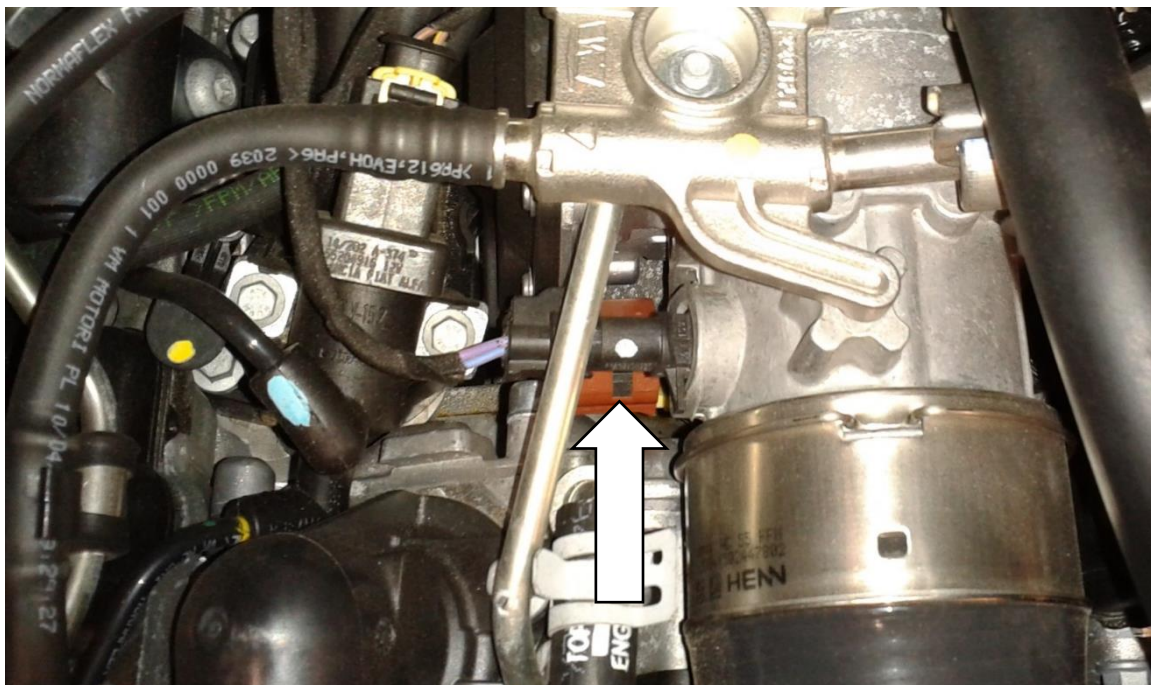

2008-2010 GMC 6.6

Passenger side of engine, between the air box and the alternator. The electrical connector is on the bottom of the valve.

NOTE: Removing the air intake tube between the air box and engine makes for easier access to the valve's electrical connector.

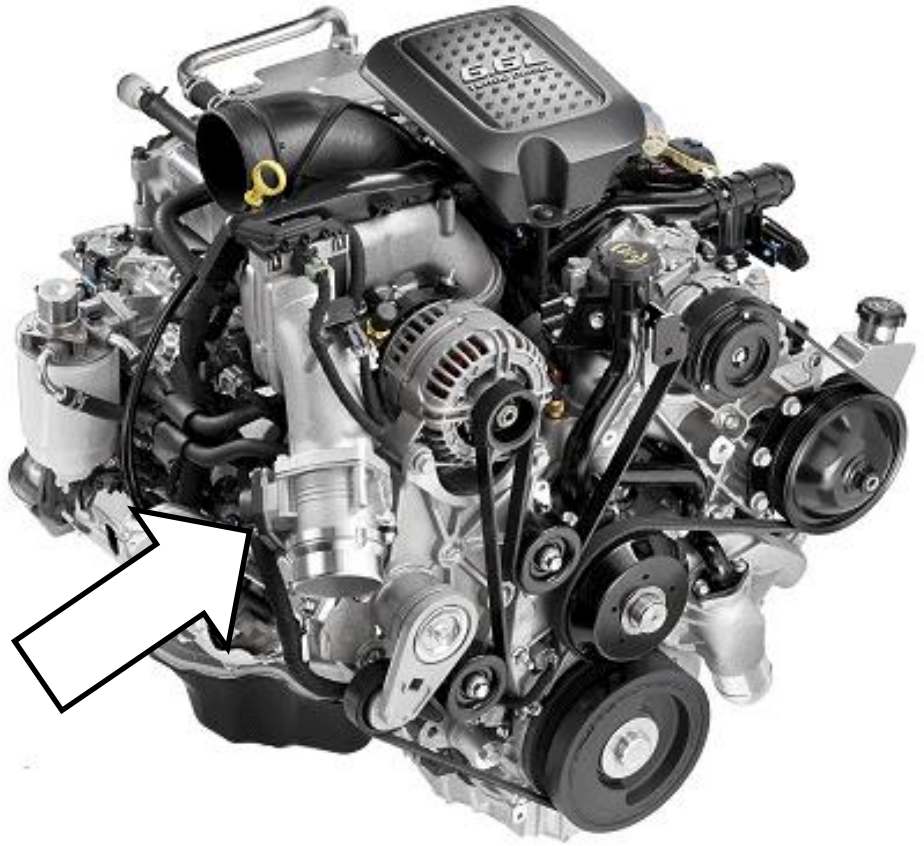

2011-2016 GMC 6.6

Passenger top side of engine. The electrical connector faces the front of the vehicle.

NOTE: The red connector lock tab must be engaged or connector may come apart from the BD harness.

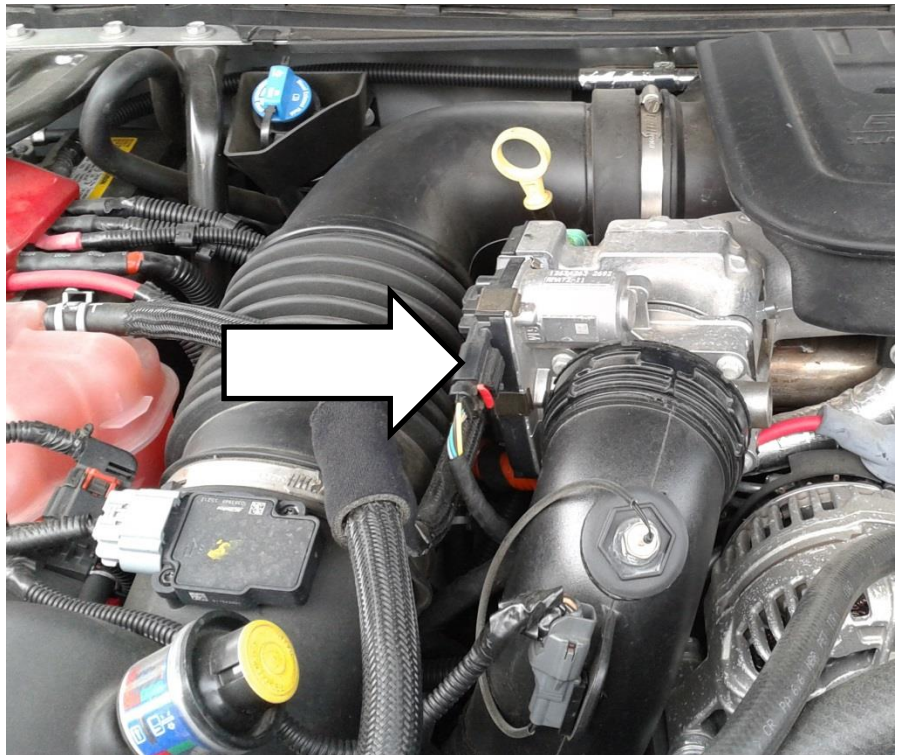

2016-2022 GMC 2.8L

Top of engine, driver's side. Removing the plastic engine cover will grant better access. Electrical connector location indicated by arrow.

NOTE: Ensure the OE harness lock tab is engaged or the connector may come apart from the BD harness



2017-2022 GMC 6.6L

Passenger side below the intake air tube. Remove the intake tube by loosening the two hose clamps. The electrical connector is then easily accessible.

NOTE: Ensure the gray lock tab is engaged on this connection or the connector may come apart from the BD harness.

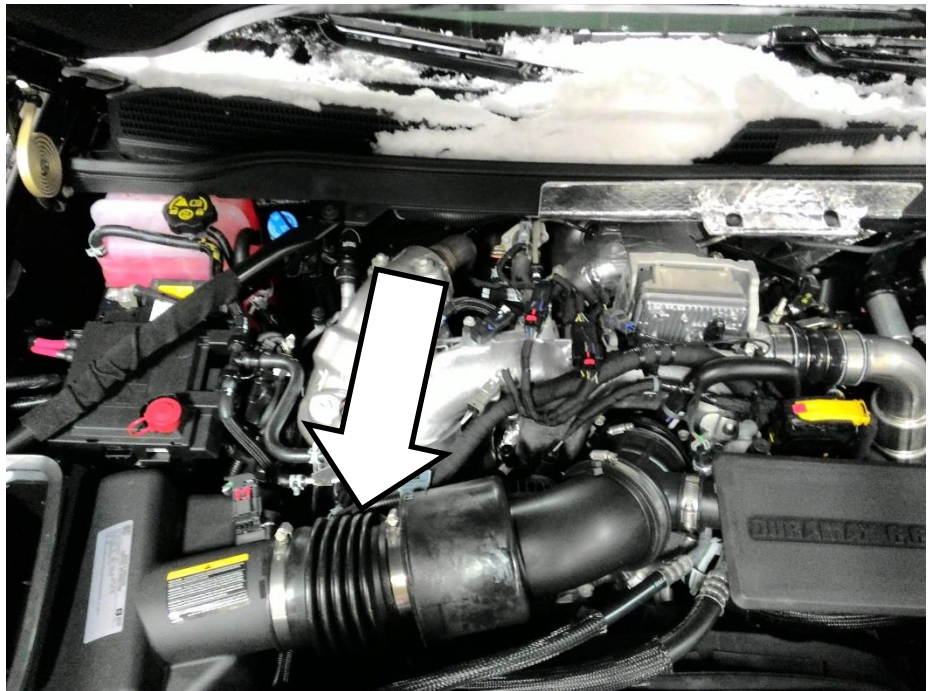

2019-2023 GM 3.0L (LM2/LZ0)

Front top of the engine. Removing the plastic engine cover helps access the intake air valve.

NOTE: The red connector lock tab must be engaged or connector may come apart from the BD harness.

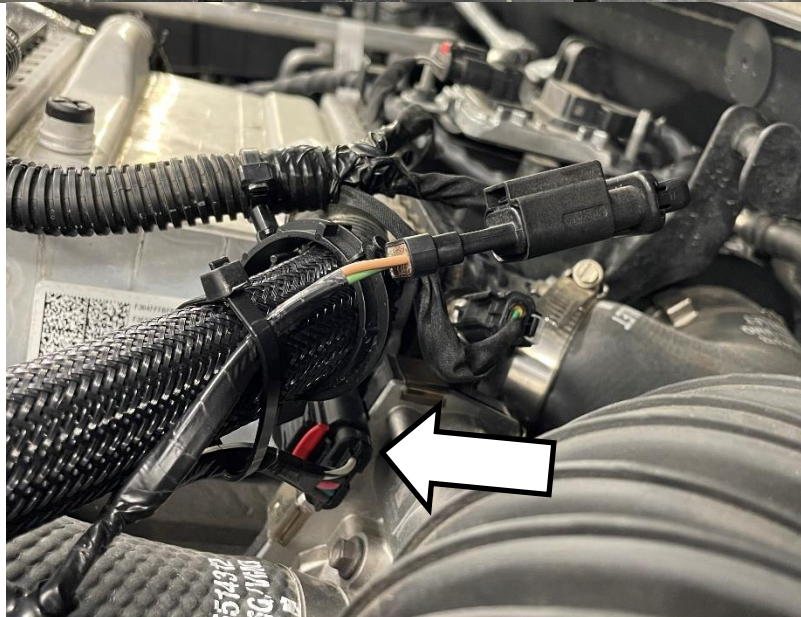
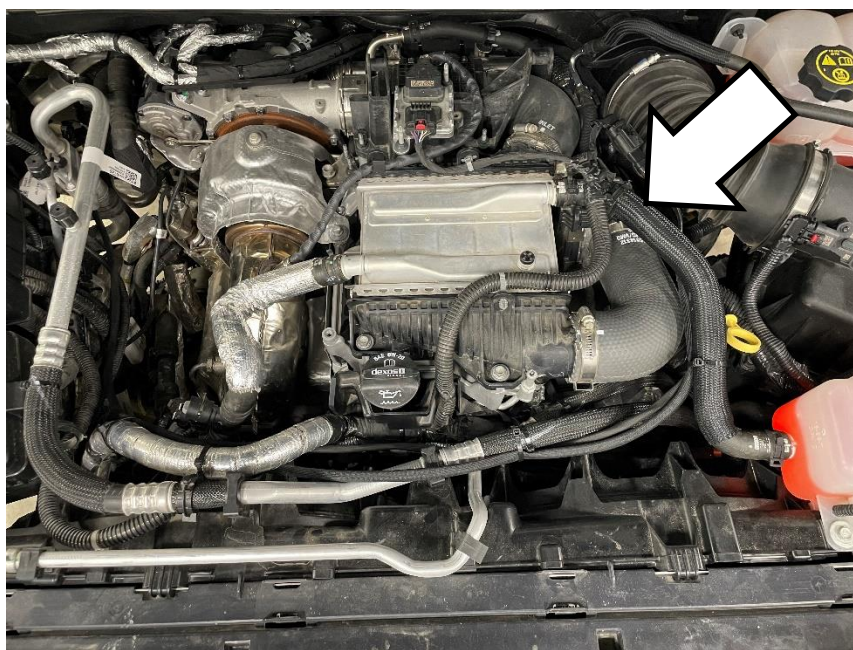

2008-2010 Ford 6.4

Front top of engine, behind the radiator fan shroud. The electrical connector is located on the back side of the valve.

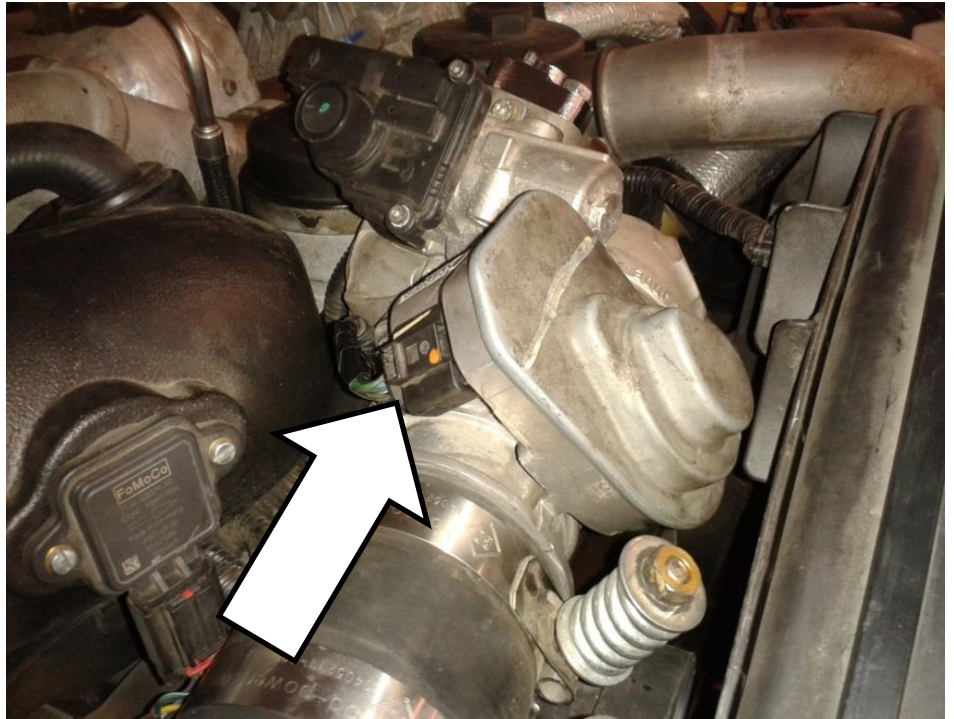
**2011-2024 Ford 6.7**

Front top of engine, behind the radiator fan shroud. The light brown electrical connector is located on the bottom front side of the valve.

NOTE: Removing the plastic charge air tube from the valve makes for easier access to the valve's electrical connector.

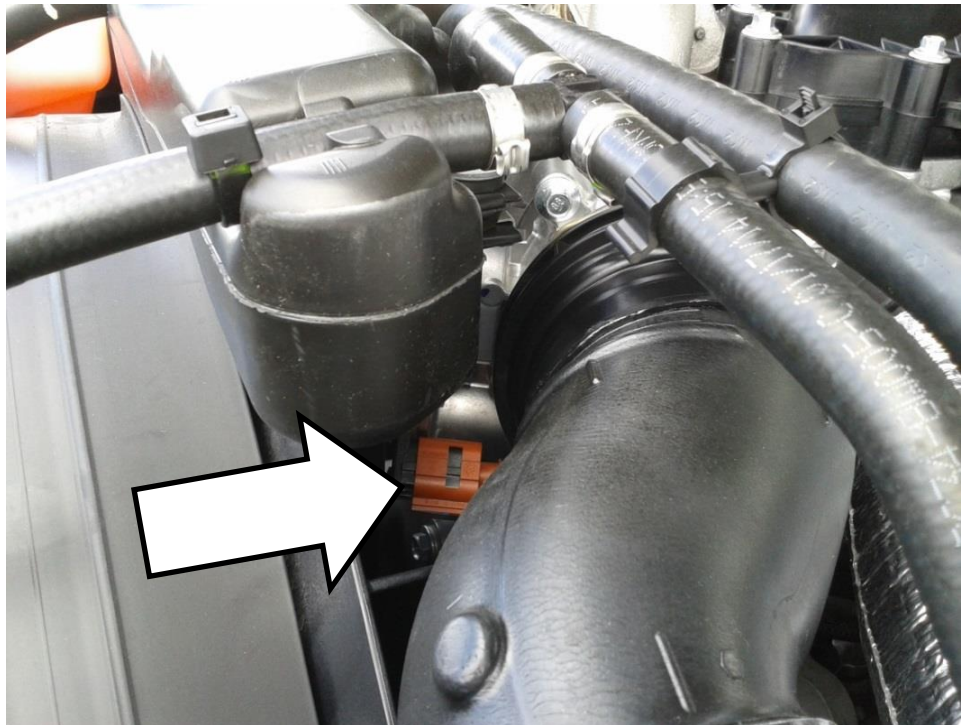

2018-2021 Ford 3.0

Front top of engine below the
air intake pipe.

NOTE: The red connector
lock tab must be engaged or
connector may come apart
from the BD harness.

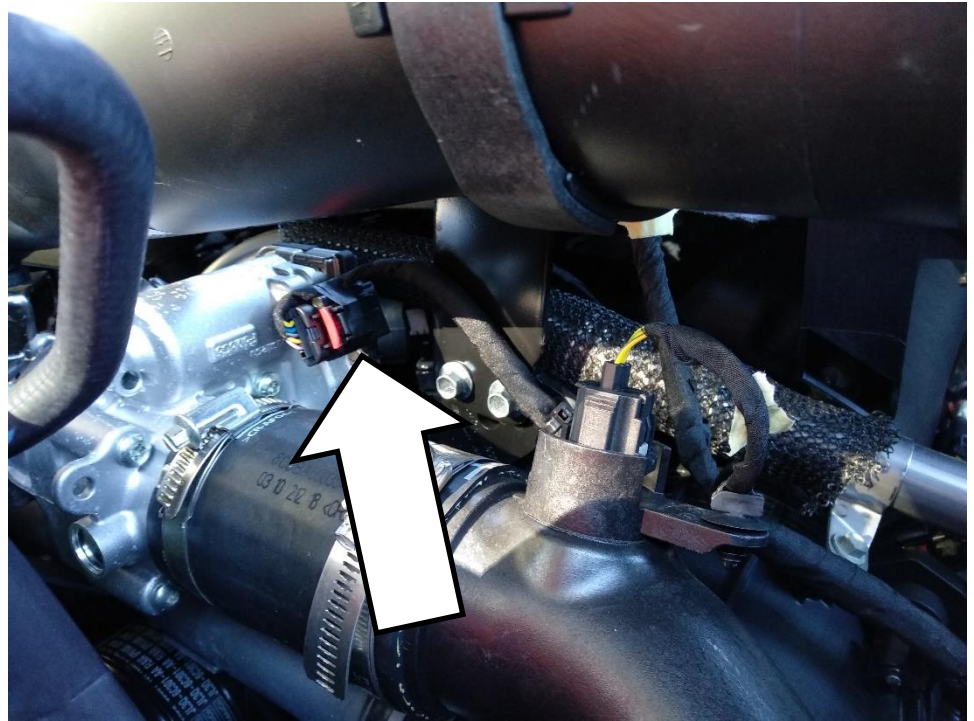

2. Locate engine crankshaft position sensor on the motor. Connect the supplied BD PAS wiring harness inline so that the BD harness connects to the crankshaft position sensor and to the vehicles original wiring.

NOTE: The 3.0L EcoDiesel will use the camshaft position sensor instead of the crankshaft position sensor.

Crankshaft position sensor locations

2007-2022 Dodge 6.7

Driver side of engine just behind crankshaft drive belt pulley.

NOTE: Do not mistake for the camshaft position sensor located above



2014-2023 Dodge 3.0

Front of engine, mounted on the camshaft closest to the driver's side fender.

NOTE: The 3.0L EcoDiesel will use the camshaft position sensor instead of the crankshaft position sensor.

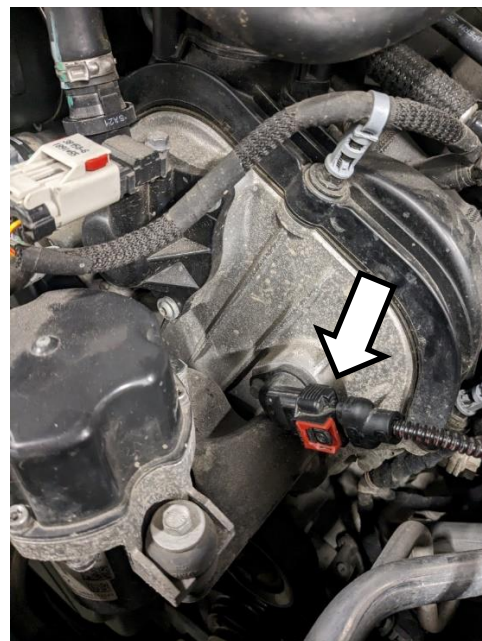

2008-2016 GMC 6.6

Passenger side of engine beside crankshaft drive belt pulley.

NOTE: Do not mistake for the camshaft position sensor located beside the water pump pulley

**2016-2022 GMC 2.8L**

Lower driver side of engine, the electrical connector is mounted at the side of the oil pan.



2019-2023 GM 3.0L (LM2/LZ0)

The crankshaft position sensor is located at the back of the engine on the passenger side.

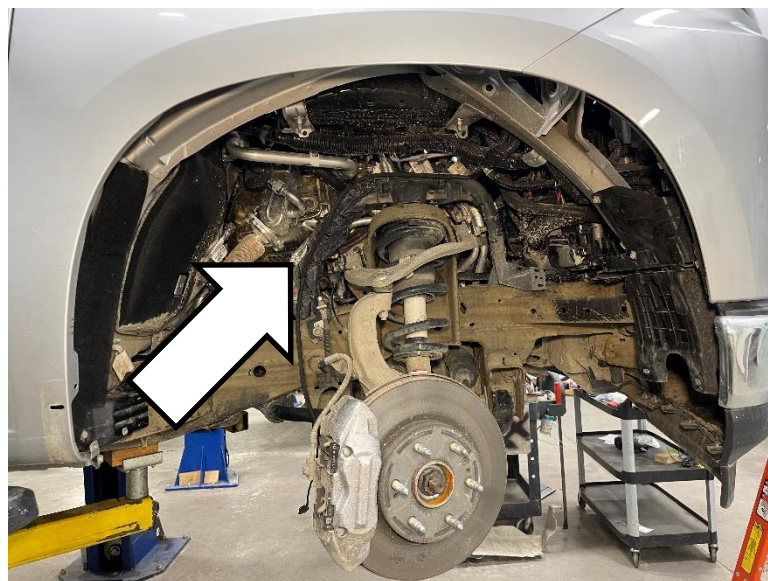
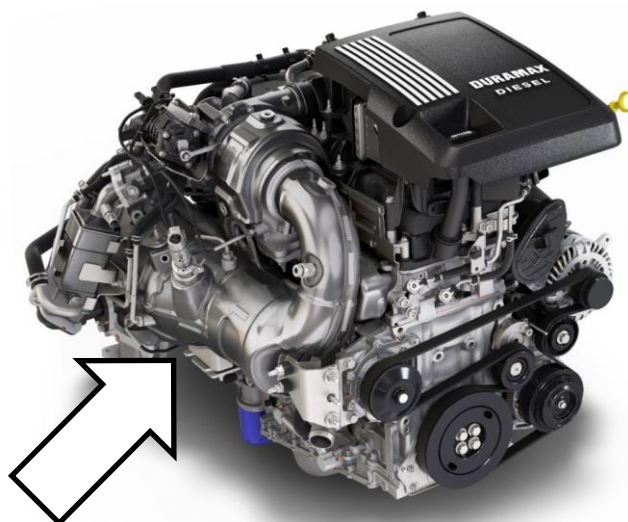

Remove the passenger side wheel, fender liner, and skid plates to get closer to the sensor. The sensor is behind a heat shield near the exhaust that can be unscrewed and moved out of the way as shown:

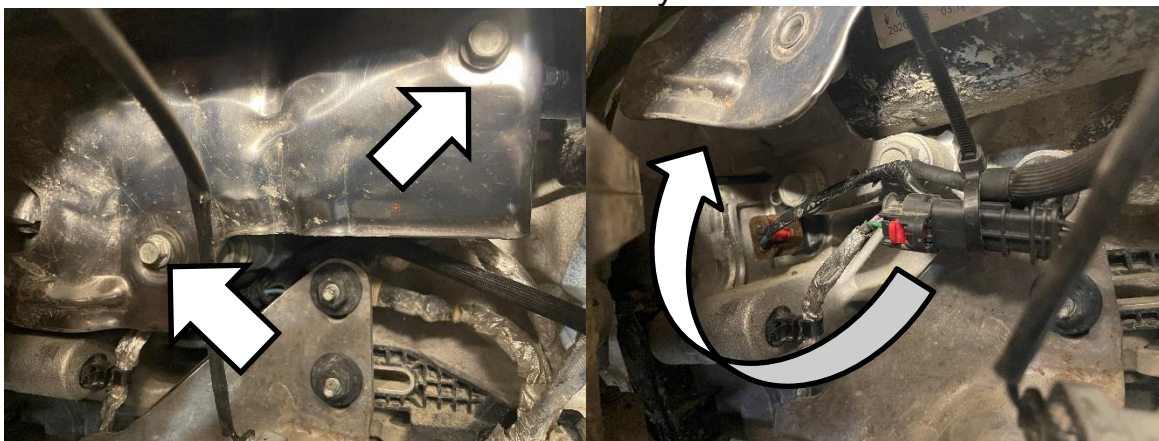



If the shield can't be accessed from the side then a bracket can be removed to gain access from below. The following four nuts need to be undone to remove the bracket:

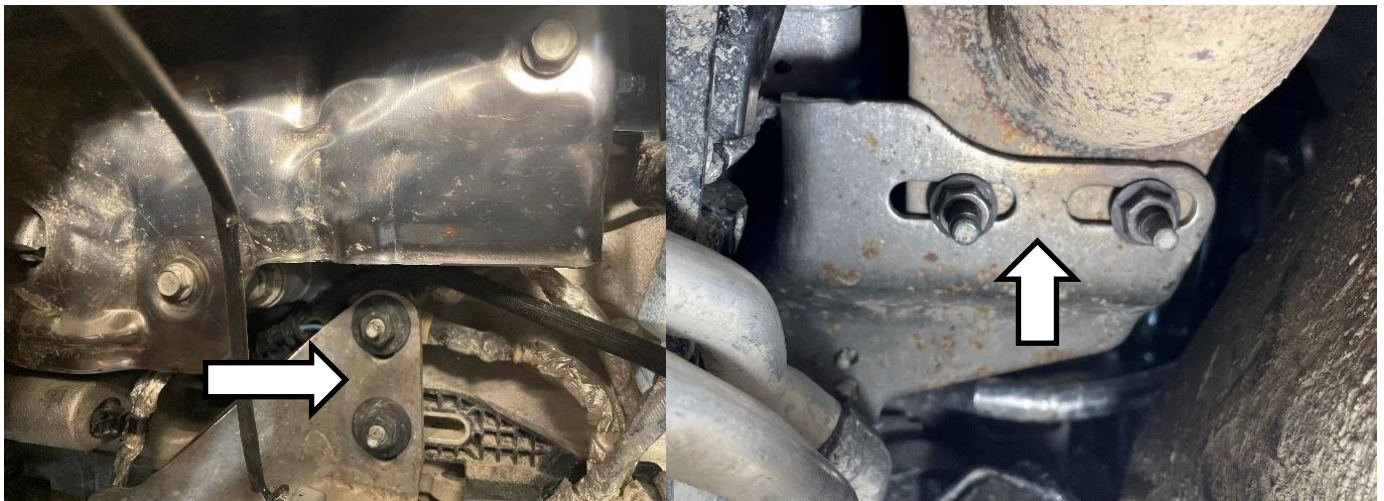

NOTE: Make sure the battery is not connected since the shield can short the starter motor located above the sensor.

2017-2022 GMC 6.6L

The crankshaft position sensor is not accessible on this engine as it is behind the starter motor. Instead, the BD harness plugs in to an inline harness connector at the top of the motor. This is the 8-pin connector.

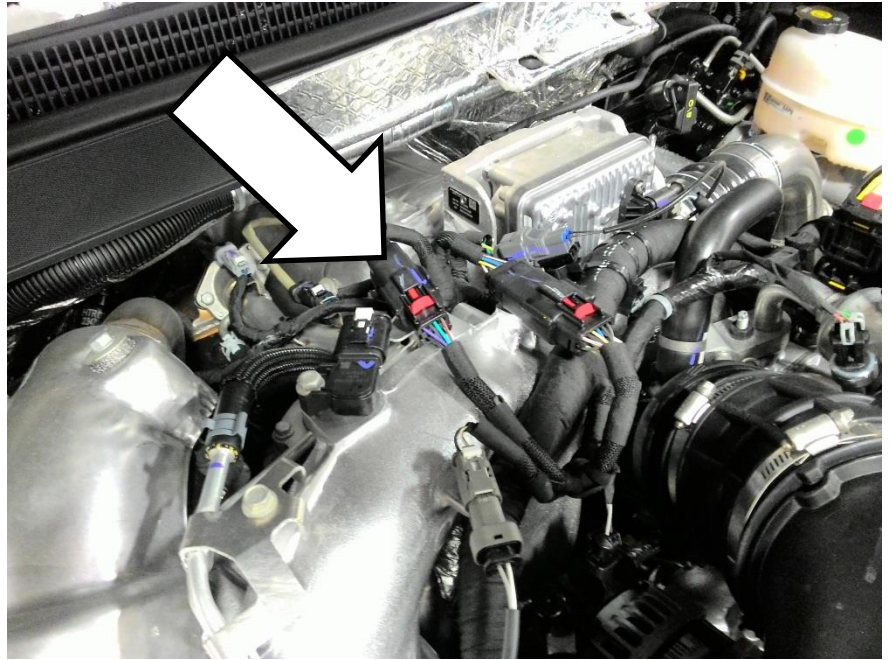

2008-2010 Ford 6.4

Passenger side of engine, bottom front. To gain better access, remove the bolt securing the passenger side of the upper steering stabilizer shock absorber and swing out of the way. A long-handled screw driver or similar tool can help push the connector off once released.

NOTE: Do not mistake for the camshaft position sensor on the opposite side of the block).



2011-2024 Ford 6.7

Driver side of engine block in transmission to engine adapter flange. Remove rubber plug from access hole to reach the electrical connector behind it.

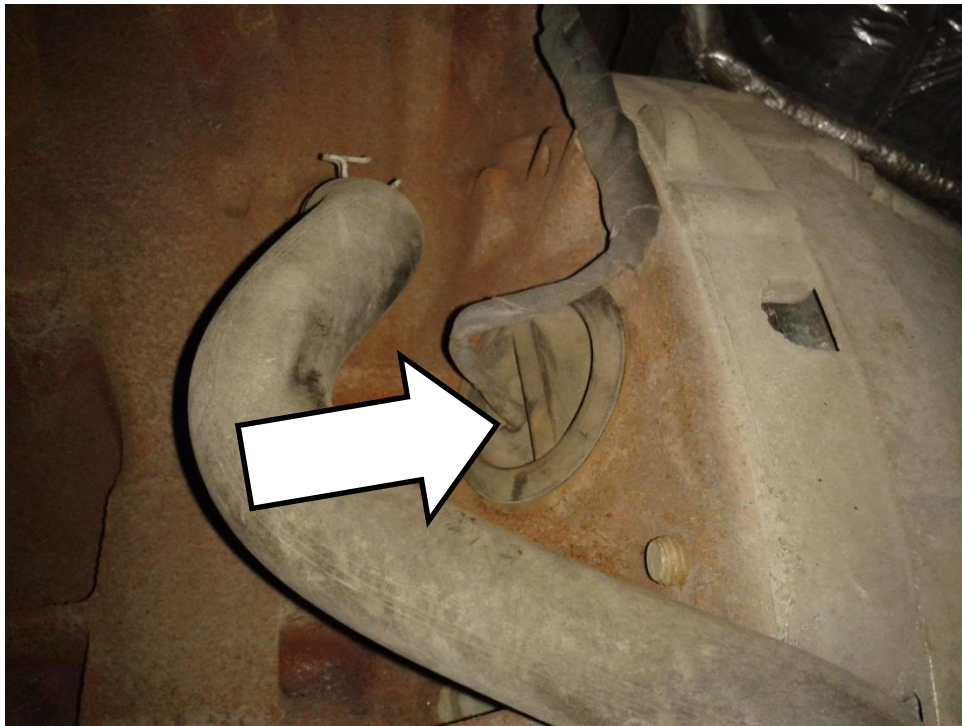

2018-2021 Ford 3.0

Driver side rear of engine, clipped to the dipstick tube.

Use care when routing the BD wiring harness to keep it away from the exhaust manifold.

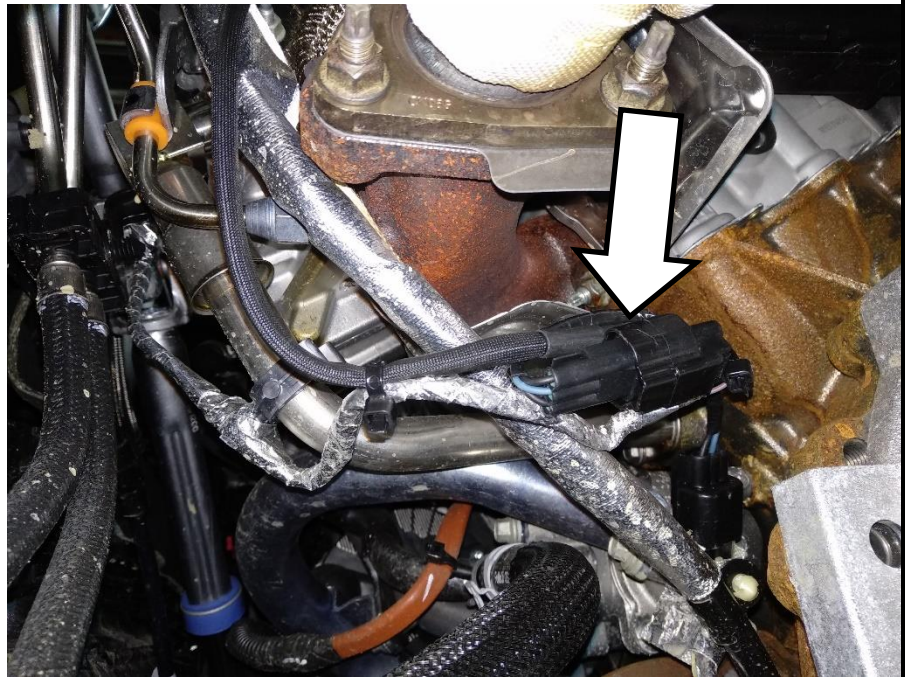

It is necessary to remove the rear belly pan to access the crankshaft position sensor. This is removed with four 8mm and one 11mm fastener.



3. Remove the toggle switch from the supplied switch harness. Route the end of the switch wiring harness from within the engine bay, through the driver's side of the firewall to below the dashboard. Suggested pass through location is through a slit in the existing grommet for the engine to instrument panel wiring harness, otherwise a new hole may be drilled and a new grommet installed if necessary.
4. Route the battery connection ring terminals to the driver side battery (2019 F150 use passenger side). Connect BLACK wire ring terminal to the driver side battery negative or to body ground if desired. Leave the RED positive wire disconnected until end of installation.
5. Locate suitable location for BD PAS module so that it will reach both wiring harnesses. Attach it with supplied adhesive hook and loop tape or wire ties. Suggested mounting location is on top of the plastic fuse box cover on the driver side of the engine bay. If using hook and loop tape, thoroughly clean the mounting surface for good adhesion.

Module Mounting Locations

2007-2024 Dodge Driver side fuse box



2008-2022 GMC

Fuse box on driver side of the engine bay



2008-2024 Ford 6.7L

Driver side rear of the engine bay behind or beside the coolant bottle



2018-2021 Ford 3.0L

Passenger side of engine bay, at fuse box location



2019-2023 GM 3.0L (LM2/LZ0)

Passenger side of engine bay at fuse box



6. Carefully secure all wiring within the engine bay with supplied wire ties to that it is away from moving parts, chafe hazards and heat sources. Use extra care with the crankshaft position sensor wiring due to the close proximity to belts, fans and road debris and potential consequences of a short or break in this wire.
7. Inside the cab, reconnect the toggle switch to the switch wiring harness in the same way they were removed. See below for reference. Double check the connections here as wiring the toggle switch incorrectly may damage the module.

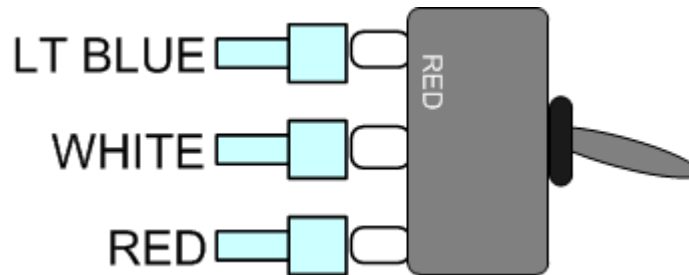

8. Locate suitable spot to mount switch on the dashboard within reach of the driver and in a highly visible location. Ensure there is sufficient space behind the dash to mount the switch. Drill a 1/8" pilot hole, then using a stepper bit (unibit) drill a 1/2" hole in the dashboard. Install switch with the groove in the thread boss facing down. Install with either the supplied switch decal or with the supplied switch guard and apply decal to the switch guard. Secure wire below the dashboard using supplied wire ties.
NOTE: A switch bracket has been supplied as an alternative for mounting the switch.

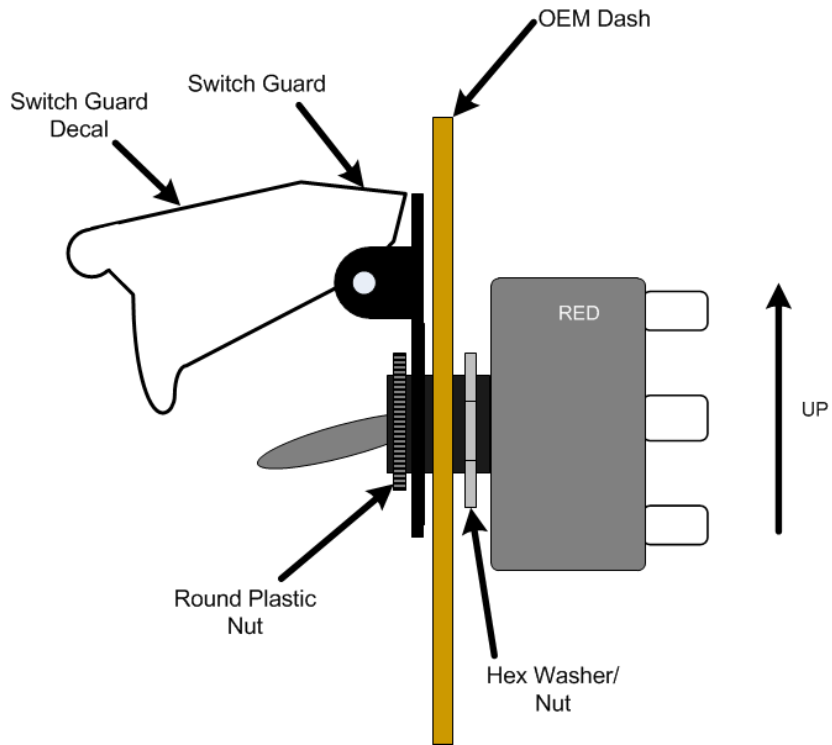

Switch decal



Switch Guard with decal applied.



9. Connect RED positive feed wire to the battery or the positive stud at the fuse block.
10. Test and verify system functionality. *Ford 6.7L read important note below first.*

Manual Activation Test: With the engine running at idle, momentarily toggle the PAS switch on the dashboard. The engine should stop within a few seconds. Wait at least 10 seconds before restart.

Automatic Activation Test: With engine not running, remove the cover from the module to access the circuit board. Keep away from metal objects that may cause a short circuit. Set the bottom switch to “1500 RPM TEST” mode. This will cause the module to shut the engine down if it exceeds 1500 RPM. Start the vehicle and slowly accelerate the engine, verify that it shuts down over 1500 RPM. Wait at least 10 seconds before restart.



NOTE: The BD E-PAS module is connected to constant battery power unless the harness fuse is removed. Use care when opening module to avoid short circuiting it against metal objects in engine bay.

IMPORTANT: *The 2011-2019 Ford 6.7L trucks will set code P0069 if the EPAS is used to shut the truck off twice in a row. This is due to the factory programming and is not a problem specific to the BD EPAS. After the truck has run & been shut off normally twice in a row, this code will clear. If the engine light comes on; the code will need to be cleared with a scan tool. This does **not** apply to 2020+ trucks.*

11. Set the operation mode switch on the circuit board back to AUTOMATIC and Set the automatic RPM shutdown speed on the module according to the engine it is installed with. This must be above the normal engine redline to avoid accidentally setting it off during driving. Reinstall module cover and re-secure module.



Make/Engine	RPM
Dodge 6.7L	4200 RPM
GM 6.6L, Ford 6.7L	4600 RPM
Ford 3.0L, 6.4L Dodge 3.0L GM 2.8L, GM 3.0L	5000 RPM

Electronic PAS system operation

The BD Electronic PAS module constantly keeps track of engine speed and will automatically stop the engine if it exceeds the preset maximum RPM. The air valve can be shut at any time even if the engine is not running by toggling the switch on the dash manually.

When the engine is off, the BD E-PAS module will go into a low power consumption state and the toggle switch on the dash will not be lit. Once the engine is started, the module will automatically begin monitoring engine RPM and the toggle switch on the dash will light up to show the system is ready.

If the system is triggered automatically or manually by the switch, the intake air valve will close and remain closed until the engine RPM has dropped to zero and for an additional 5 seconds afterward. During this time the toggle switch will flash to indicate a closed valve position. **DO NOT ATTEMPT TO RESTART ENGINE WHILE VALVE IS CLOSED.** The valve will automatically reset itself to the open position and the toggle switch light will turn off once shutdown process is complete.

Ford 6.7 – Read important note in step 10

Troubleshooting

Valve does not close by manual toggle switch activation

No power to module. Check fuse at battery. If fuse is blown, inspect harnesses for short circuits or other problems. Remove cover from module and check that the POWER lamp is flashing every two seconds with engine off indicating it is powered and in standby.

Incorrect switch wiring. Carefully check the toggle switch wire connection is correct, incorrect connection may damage the module.

Intake air valve connectors not fully seated. An audible click should be heard when the connector is fully mated together. Tug on connector to ensure it does not come apart.

Valve closes by manual toggle, not automatically

Incorrect module mode setting. If conducting low speed system test, verify that the lower switch on the module circuit board is set to the middle position, "1500 RPM TEST". For normal automatic operation, the switch should be fully counter clockwise, "AUTOMATIC" and RPM selector switch is set to the correct speed.

Harness connected to camshaft position sensor rather than crankshaft position sensor. Verify against pictures in installation section of this manual.

No RPM signal to module. Open module cover and start engine. Verify that RPM light is flashing when engine is running and POWER light is on solid. If it is not on or is intermittent, carefully check blue wire from the module's black connector (pin 7) to the crankshaft position sensor is not severed.

Engine light on / fault codes set

Code set during installation. If the ignition switch was on or ECM had not powered down during installation, fault codes may be set by disconnecting air valve. Clear codes and recheck.

Intake air valve connectors not fully seated. An audible click should be heard when the connector is fully mated together. Tug on connector to ensure it does not come apart.

Black connector disconnected from BD E-PAS module. If the module is not currently being used, the black connector must still be plugged into the module or the valve connected back to stock configuration.

2017+ GM 6.6 *will* set a P0106 on every shutdown event. This is normal for this particular engine.
2011-2019 Ford 6.7 read note in step 10.

2019+ GM 3.0L will not set a code when the engine is shut off while idling. At higher RPMs when the engine is shut off, then code P122D will be set. The error code P122D is set when the intake airflow valve exceeds its learned limit. This does not harm the engine and needs to be cleared.

Engine does not start

Connectors not mated. Inspect crankshaft position sensor connector is correctly installed; an audible click should be heard when connected. Tug on connectors to verify they are correctly mated.

Shorted crankshaft position sensor wire. Inspect the blue wire from the module's black connector (pin 7) to the crankshaft position sensor; if this wire is chaffed or broken it may short out the crankshaft position sensor signal.

Intake air valve jammed shut or defective. Toggle the system manually while listening for valve movement. If suspect, remove the intake air tube from the valve and visually verify the intake air flap is not closed.

Circuit board switch and LED functions

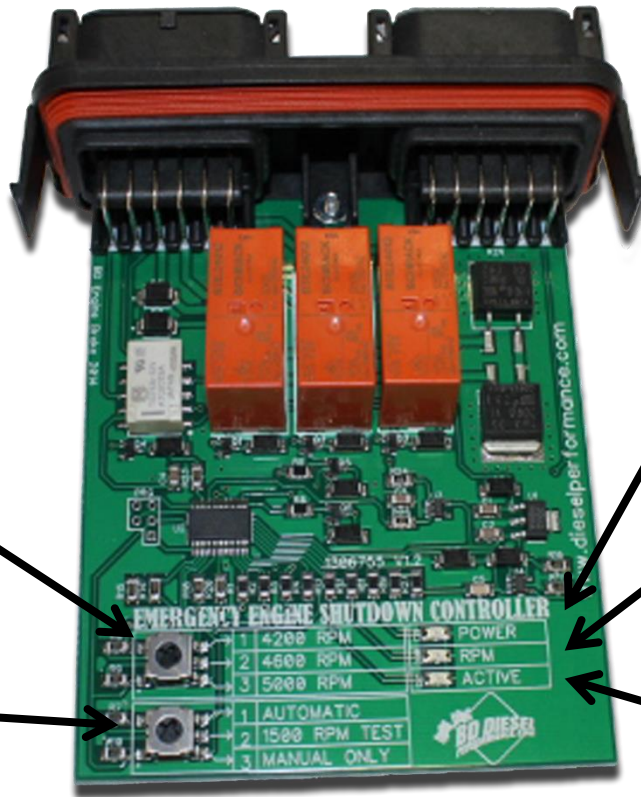

Maximum engine RPM for automatic mode

Operation Mode: Automatic, test or manual only.

Power light on when engine running. Flashes every 2 seconds when in standby.

RPM light flashes when the engine is running.

Active light on when the valve is controlled by the module.

If you have any technical difficulties please phone our Technical Support hotline at (800) 887-5030 between 8:30am-5:00pm PST (Pacific Standard Time) Monday to Friday

Wiring diagram

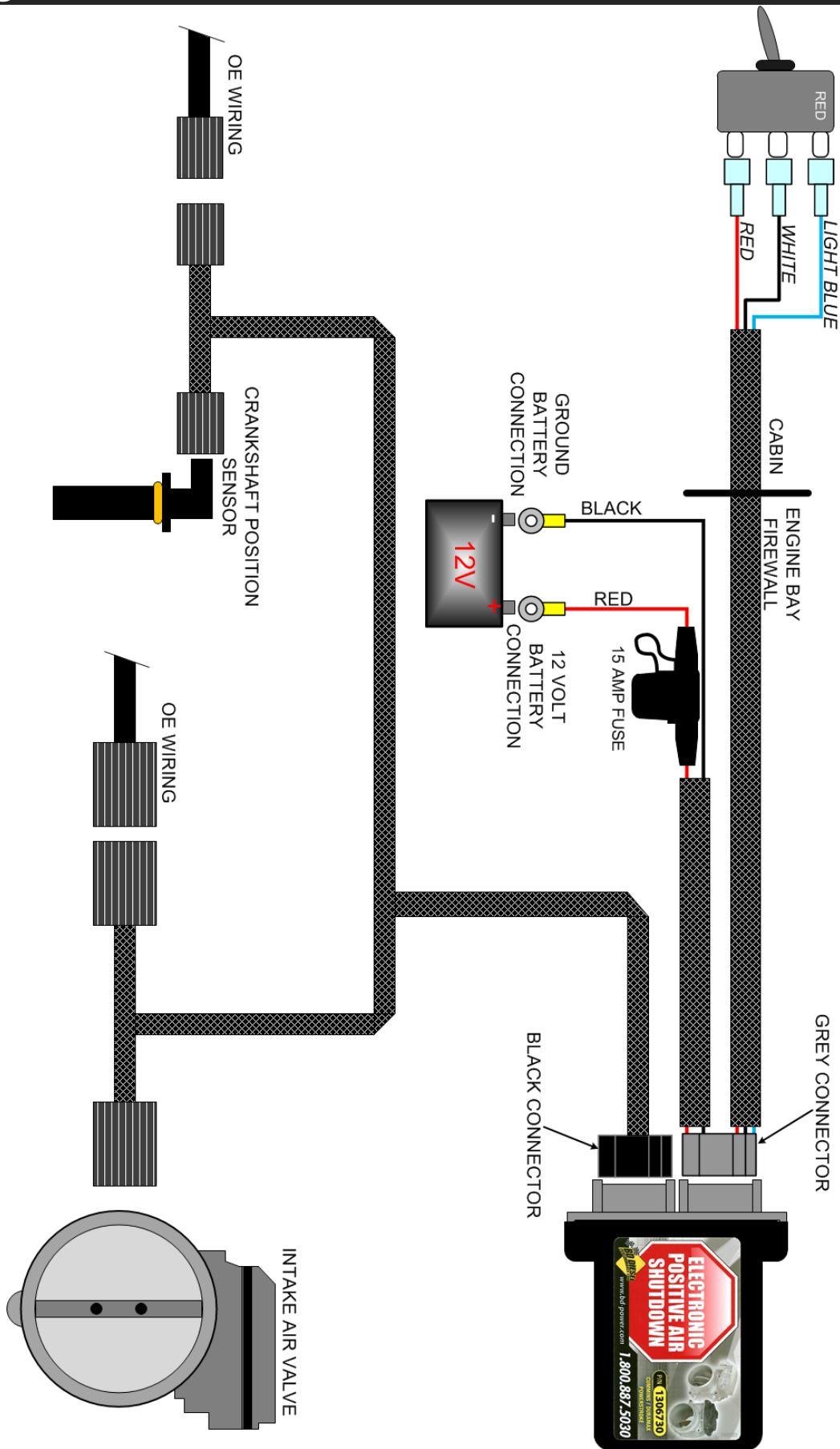

BD ENGINE BRAKE, INC.

Plant Address: A10-33733 King Rd, Abbotsford, BC, Canada V2S 7M9

US Shipping Address: 1124 Fir Avenue, Blaine, WA 98230 US Mailing Address: PO Box 231, Sumas, WA 98295

Phone: 604-853-6096 Fax: 604-853-8749 Internet: www.bddiesel.com