



***DOWNLOAD COLOUR  
INSTALL MANUALS AT  
[www.bddiesel.com](http://www.bddiesel.com)***



# **BD HD TRANSMISSION PAN**

**2017+ Ford Trucks and SUVs**

With 10R60/10R80

**1061717**

**Pan Kit w/o Gasket & Hardware**



**1061718**

**Pan Kit w/ Gasket & Hardware**

Note: Replacement of your transmission filter is recommended.

## Kit Contents

### 1061717 & 1061718:

1200208	1601613	1601718
		
1/8" NPT Plug	Magnetic Drain Plug	Transmission Pan
<b>Qty: 1</b>	<b>Qty: 1</b>	<b>Qty: 12</b>

### 1061718 Only:

FT-0173255	W714629-S442
	
M6 SS Flange Nut	OEM Heat Shield Stud Bolt
<b>Qty: 6</b>	<b>Qty: 1</b>
FT-11508902	HL3Z-7A191-B
	
M6 x 25mm SS Flange Bolt	Pan Gasket
<b>Qty: 1</b>	<b>Qty: 1</b>

## Tools Required for Installation

- Ratchet (Flex Head Recommended)
- 5/16" Hex Socket
- 8mm Socket and Wrench
- 10mm Socket and Wrench
- 13mm Deep Socket
- 15mm Deep Socket
- 19mm Socket
- 21mm Deep socket
- Torque Wrenches (20 in-lb min, 76 ft-lb max)
- Floor Jack or Under Hoist Stand (4WD Only)
- Blue Threadlocker
- Thread Sealant
- Fluid Pump or Long Funnel

## Specs At A Glance

Fluid		
Trans Fluid	8-10 Quarts of Mercon ULV ATF	
Torque Specs		
Drain Plug	20 ft-lbs	All
1/8" NPT Plug	12 ft-lbs	All
Pan Stud Bolts	106 in-lb	All
Pan Bolts	89 in-lb	All
Heat Shield Nuts	80 in-lb	All
Oil Cooler Bolts	22 ft-lb	All
Cooler Line Bracket Bolts	22 ft-lb	All
Sway Bar Nuts	41 ft-lb	All
Dipstick/Fill Plug	52 ft-lb	All
Filter Bolts	93 in-lb	As Required
Fabric Shield	71 in-lb	As Required
Passenger Cooler Line Bolt	35 ft-lb	5.0L Trucks Only
Transmission Mount Nuts	76 ft-lb	4WD Only
Cooler Line to Engine Oil Pan	20 in-lb	3.5L Trucks Only
Cooler Line Bracket Nut	106 in-lb	2.7L and 3.5L Trucks Only

## Note

The symbol shown:

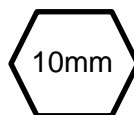

Represents the wrench size of the fastener shown in the step.

## Installation

Park the vehicle on flat and level ground or onto a lift with the park brake applied and the transmission in park.



If equipped with a fabric shield, take out the four bolts shown and remove it.



Remove the 4 front sway bar nuts and allow the sway bar to swing downwards.



Remove the 2 bolts holding up the transmission cooler.

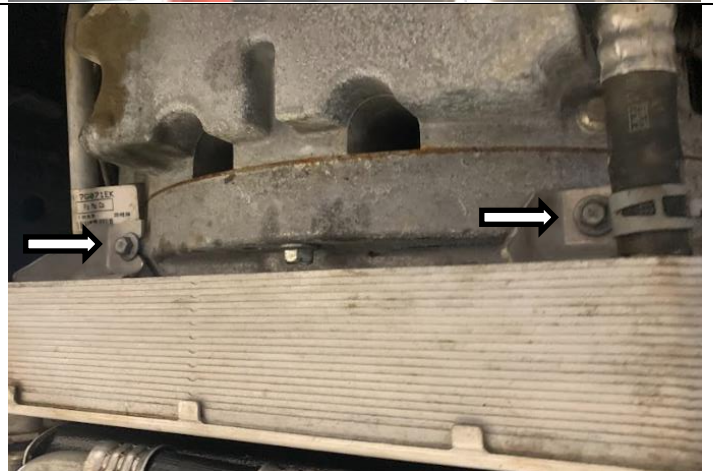

**For 3.0L Diesel, skip to 'All Vehicles' section****For 2.7L Ecoboost:**

Remove the cooler tube bracket nut located behind the starter on the bellhousing.

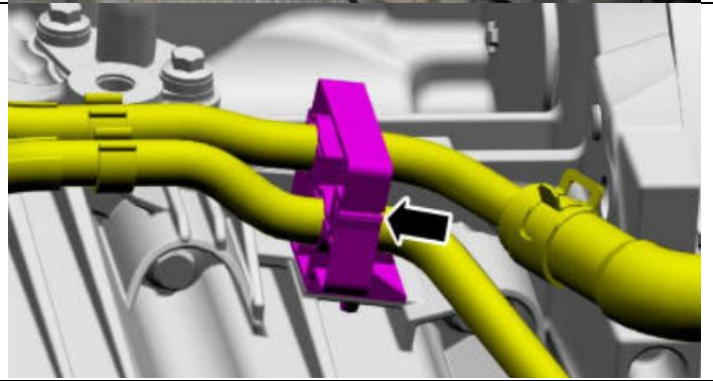

Unclip the cooler tube retainer.

**For 3.5L Ecoboost:**

Remove the cooler tube bracket nut located behind the starter on the bellhousing.



Remove the plastic clip holding the cooler tube to the right-hand side of the engine oil pan.



Unbolt the cooler line bracket holding the line to the front left of the engine oil pan.

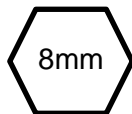

**For 5.0L:**

Remove the cooler mounting bolt on the right side of the transmission case.

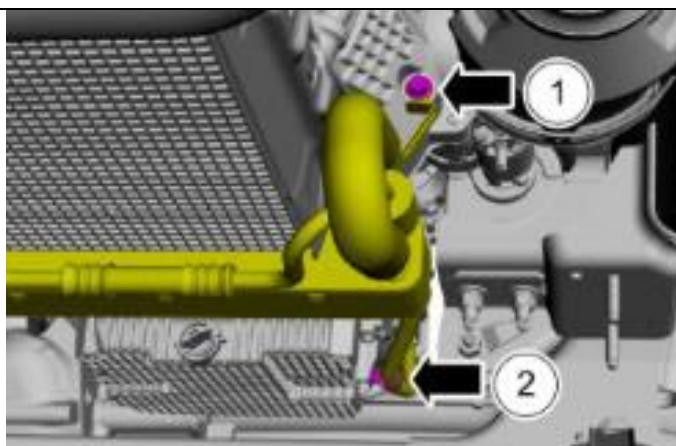

Disconnect driver's coolant tube retainer.

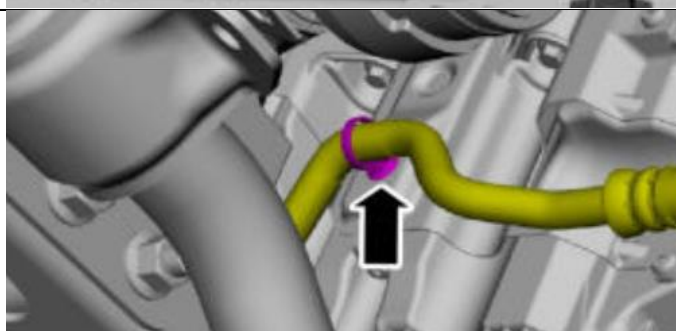

**All Vehicles:**

Place drain pan under the transmission pan.

Remove the 2 cooler line retainer bolts and pull the cooler lines from the transmission.

Carefully swing down the transmission cooler out of the way of the pan.

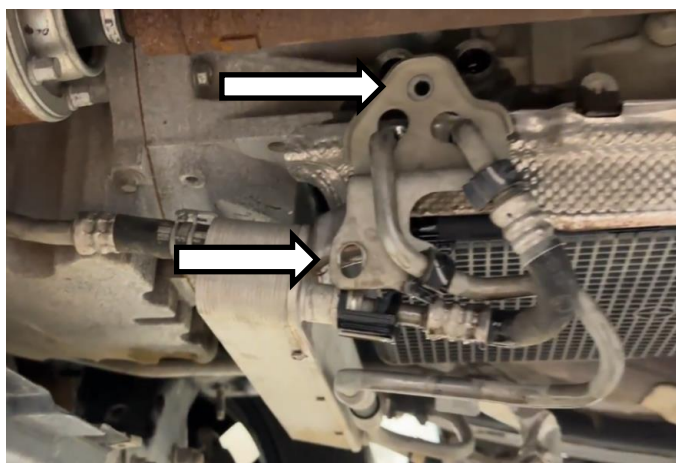

**For 4WD Vehicles:**

Remove the 2 nuts holding the transmission mount to the transmission crossmember.



Using a floor jack or lift support stand, raise the transmission until resistance is felt.

**All Vehicles:**

Remove the 6 heat shield nuts holding on the heatshields. The rear two nuts are shown.

Once off, remove heat shields.

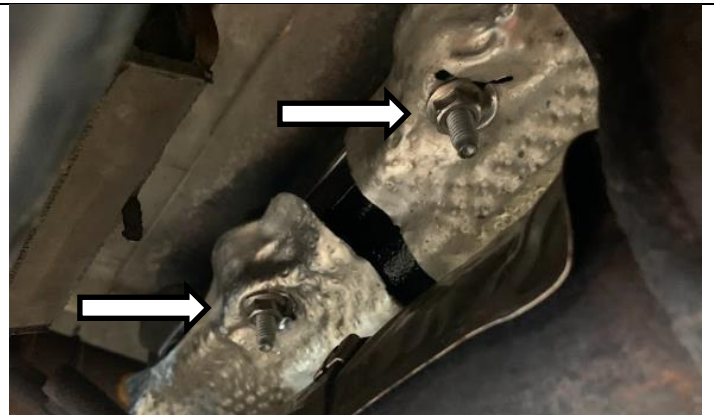

Break loose all 6 stud bolts and all 12 standard pan bolts (driver's side pictured).

Remove the front-most 6 bolts.

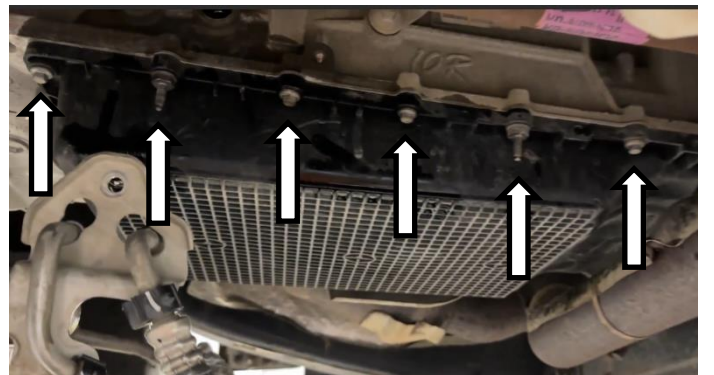
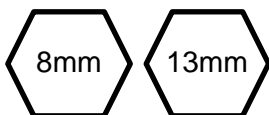

Slowly loosen and remove the bolts from front to back to allow the fluid to slowly drain out of the front of the pan.

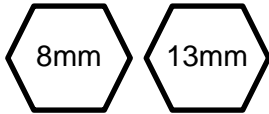

Once all but the rear bolts are removed and the majority of the fluid has drained out, remove the remaining bolts and carefully lower the pan down.

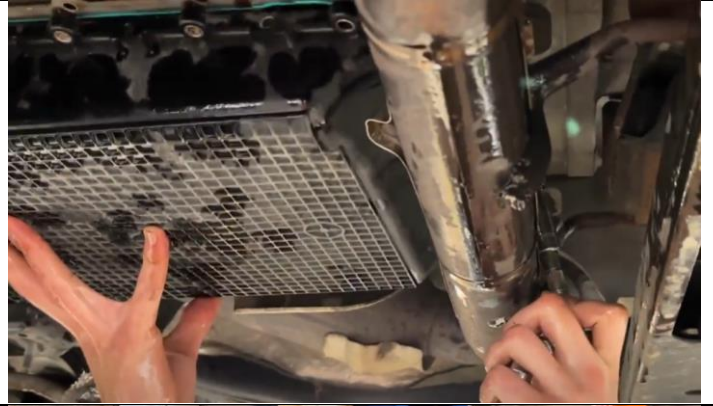

Remove the pan gasket. Discard if using **1061718**.



It is highly recommended for new filters to be installed at this time.

If replacing, torque filter bolts to **93 in-lb**. The shorter of the two bolts goes in the center hole (see arrow).





Wipe down the inside of the new pan with brake parts cleaner or another suitable substitute.

Make sure the pan rails are free of dirt and oil.



Place the pan gasket on the deep pan and align the holes. Install the pan onto the transmission, and secure with 2 opposing bolts.

Make sure the dowels on the gasket go into the holes in the case.



### Note:

If equipped with a crossover pipe, this can be a tight fit. To sneak the pan past the exhaust hanger:

- Lift the pan roughly into place
- Spin the pan 45° counter clockwise (looking from bottom)
- Slide the pan over the exhaust pipe while spinning back to 0°.

If you can't get the pan in, you can remove the 4 15mm head crossover pipe nuts behind the turbo to get additional clearance. Torque nuts to **30 ft-lb** when reinstalling.

**MOST IMPORTANTLY - DO NOT FORCE THE PAN INTO PLACE!**

Install the remaining pan hardware hand tight.

See arrows in photo for stud bolt locations.

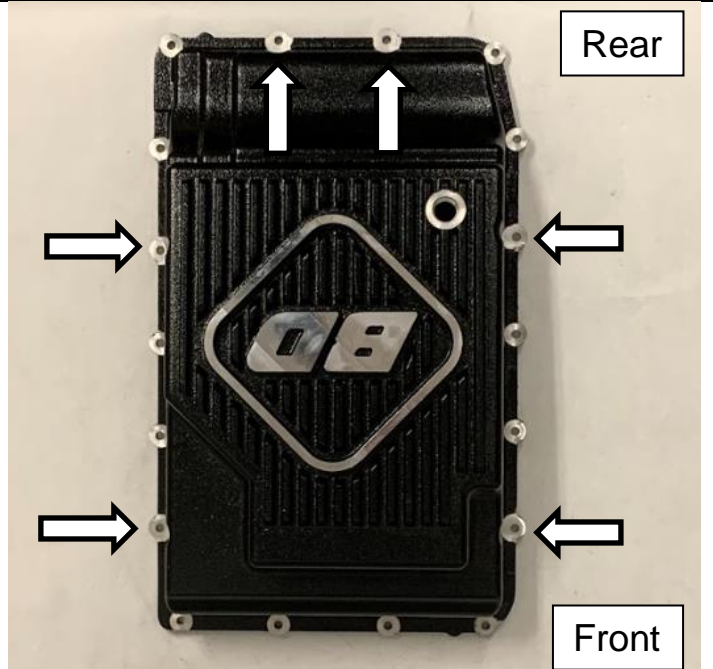
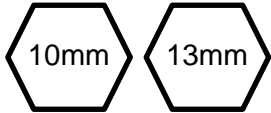

Torque the 18 bolts/stud bolts in a crisscross pattern.

Torque the stud bolts to **106 in-lbs.**

Torque the bolts to **89 in-lbs.**

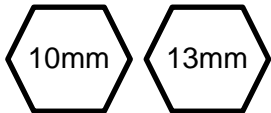

Remove and add a small amount of thread sealant to the temperature port plug.

Reinstall and torque to **12 ft-lb.**



Install the drain plug and torque to **20 ft-lb.**



Install the heat shields back on to the studs. Torque the 6 nuts to **80 in-lbs.**



The heatshields will require light trimming to allow for the installation of a temperature sensor.



#### **For 4WD vehicles:**

Lower the transmission back down and reinstall the transmission mount nuts onto the studs.

Torque to **76 ft-lbs.**

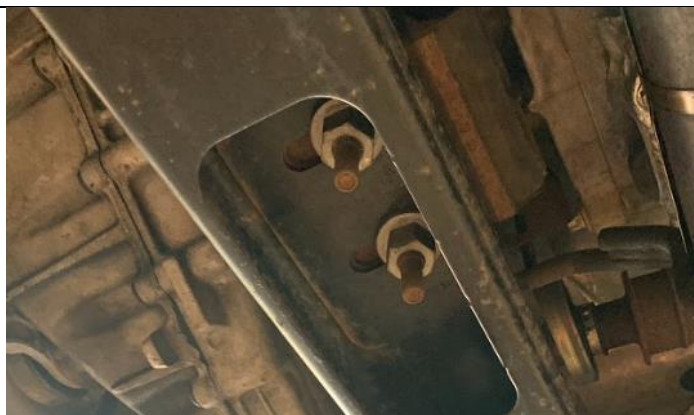

**For 3.0L Diesel, skip to 'All Vehicles' section**

#### **For 2.7L Ecoboost:**

Slide the cooler line mounting tab over the stud on the bellhousing and reinstall the cooler tube bracket nut. Torque to **106 in-lbs.**



Reconnect the cooler tube retainer.

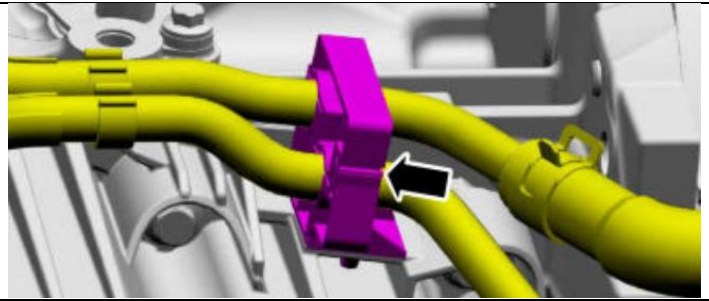

### For 3.5L Ecoboost:

Slide the cooler line mounting tab over the stud on the bellhousing and reinstall the cooler tube bracket nut.

Torque to **106 in-lbs.**



Clip the cooler line retainer back into the hole on the right side of the oil pan.



Reinstall the bolt holding the driver's side cooler line to the oil pan. Torque to **27 in-lb.**



### For 5.0L:

Reinstall the cooler mounting bolt on the right side of the transmission case. Torque to **35 ft-lb.**

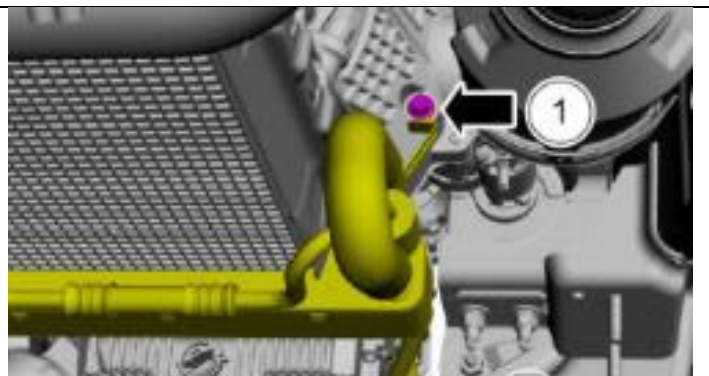

Reconnect driver's side coolant tube retainer.

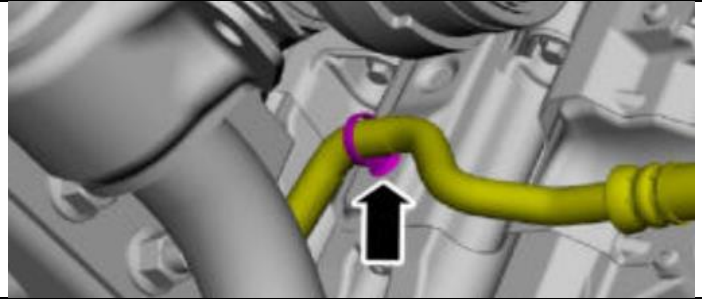

### All Vehicles:

Reinstall the 2 transmission cooler bolts.

Torque to **22 ft-lbs.**

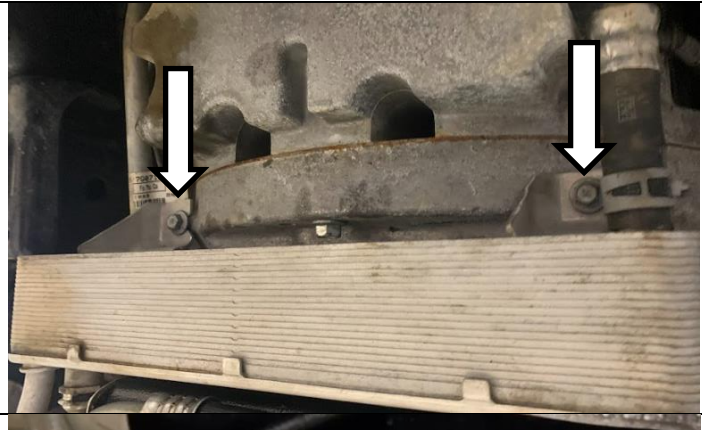

Inspect the cooler line seals and backing rings for damage. Install new seals if necessary, Ford part number 5L7Z-7J324-A.

Lubricate with transmission fluid before installing the lines.



Push the cooler lines into the case, making sure not to damage any seals.

Once installed, reapply a small amount of blue threadlocker to the two mounting bolts.

Once installed, torque both mounting bolts to **22 ft-lbs.**

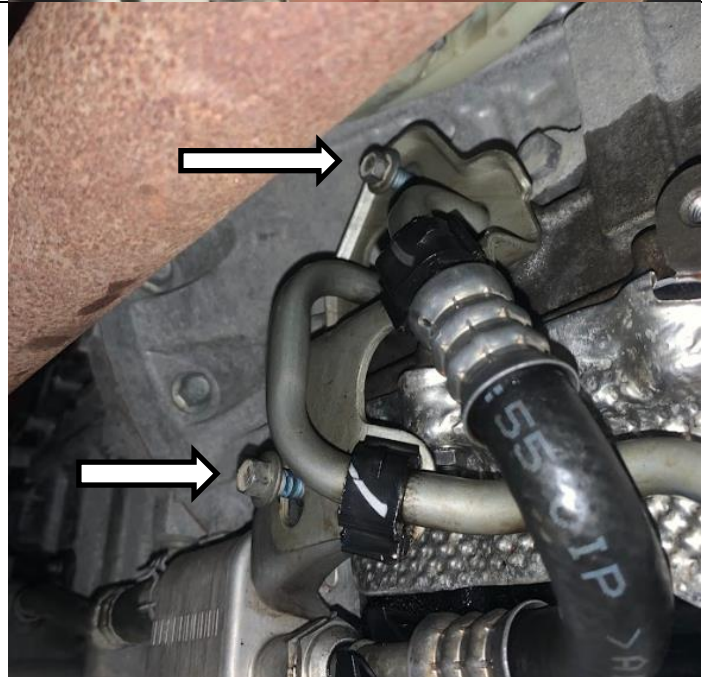

Reinstall the 4 stabilizer bar bracket nuts.

Torque to **41 ft-lbs.**



Removed the fluid indicator plug/dipstick.

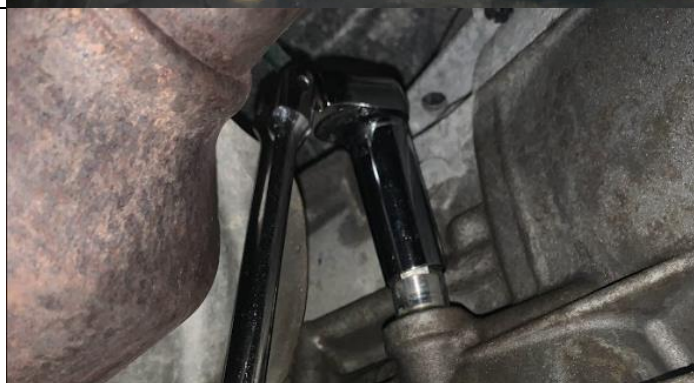

Using a fluid dispenser, add approximately:

- 7.1 quarts for a drain and fill/filter change.
- 8.1 quarts from dry after a full transmission rebuild.

Use Mercon ULV or equivalent. If a fluid dispenser isn't available, a funnel with a long hose can be used.



Start the truck. Let the transmission idle in each range for approximately 5 seconds.

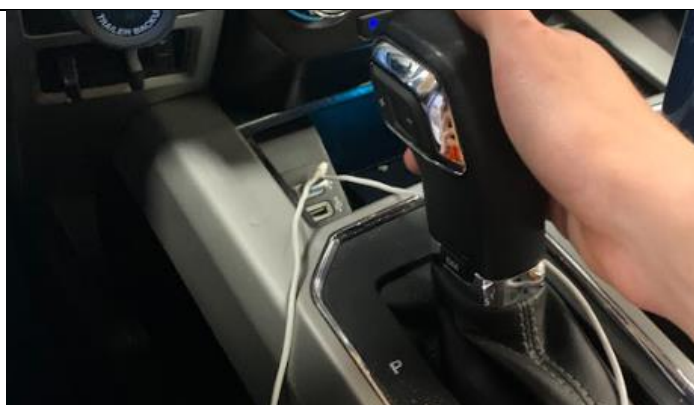

### Note:

Due to the change in material of the pan, the heat shields may make a small rattling noise on the aluminum pan. To get rid of this noise, slightly pry back the heat shields from the side of the pan with a screwdriver or comparable tool.

Check the dipstick while running in park.



For indicators with letters:

Add transmission fluid until just below the 'B' area on the indicator.

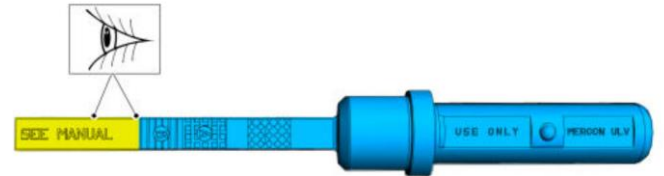

For indicators with numbers:

Fill until the fluid reaches between the bottom of the dipstick and the '6' on the indicator.

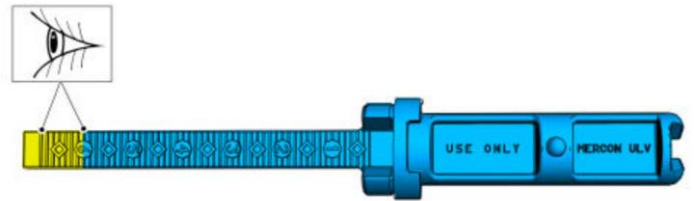

Install the fluid indicator plug/dipstick. Snug up well.



Drive the vehicle. Use a scan tool to verify the fluid is between 206°F and 215°F.

In park and idling between 600-750rpm, check the fluid level on the indicator.



For indicators with letters:

The fluid level must be within the 'B' area on the indicator.

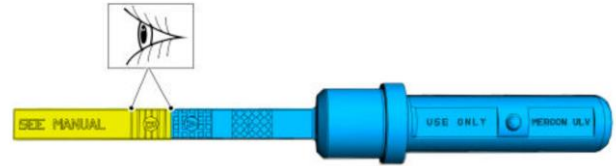

For indicators with numbers:

The fluid level must be between '5' and '6' area on the indicator.

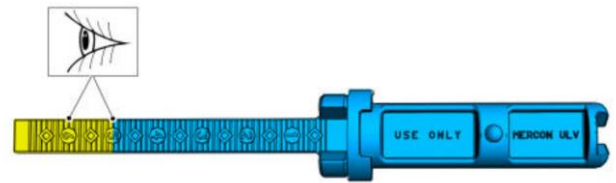

Adjust level as necessary.

Reinstall the fluid indicator plug/dipstick and torque to **52 ft-lbs**.



Reinstall the fabric shield if equipped. Torque the 4 bolts to **71 in-lb**.



Road test the truck. Check for leaks and ensure normal operation.

