



# TITANIUM SIGNATURE SERIES PLUS INSTALLATION MANUAL

## ALL 1/2" FUEL PORTS



### APPLICATION:

ND-TSP-D08-250G  
(250GPH @ 16-18PSI)  
ND-TSP-D08-290G  
(290G @ 16-18PSI)

Cummins 5.9L 24  
Valve

Standard Pickup Truck  
1998.5-2004

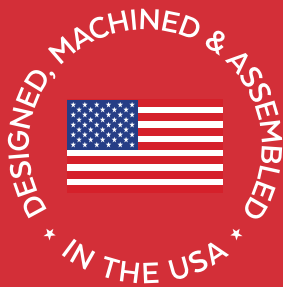

Note: Cab and Chassis  
may require modifications





[www.fassride.com](http://www.fassride.com)

(866) 769.3747

## **Thank you for choosing FASS, from Diesel Performance Products, Inc.**

FASS specializes in building extremely high-quality fuel products. We have earned an unsurpassed reputation for excellence in our industry by using only the highest-quality American-made components. In order to support our American workers and our American economy, more than 98+ percent of our products are manufactured completely in the United States.

Of course, that dedication to excellence comes at a price, but it is important to remember that price does not dictate quality-quality dictates price! We will never compromise by using cheaper, foreign-made components, like so many of our competitors do.

Customer satisfaction is our top priority and we strive always to provide outstanding customer service. Our Research and Development department, in conjunction with our Dealer Support Department, continually searches for ways to improve quality, expand our product line, and provide superb support. Our exclusive ViP Network ensures that customers receive the proper products and support at the local level. The extended lifetime warranty is only available on products purchased from the network. There is no warranty on products not purchased outside the network.

## **IMPORTANT:**

*In order to qualify for the lifetime extended warranty, your product registration form and proof of purchase from an authorized dealer must be submitted to FASS Fuel Systems within 30 days of purchase. Failure to comply will void the warranty. We have the right to deny any warranty believed to be false, altered or purchased through an unauthorized or terminated dealer. A current list of authorized dealers can be found on our website, [FASSRide.com](http://FASSRide.com).*

The complete conditions of the Limitation of Warranty can be found in the back of this manual, and [FASSRide.com](http://FASSRide.com).

**For more information,  
contact Technical Support:  
Diesel Performance Products, Inc.  
16234 State Hwy O.  
Marthasville, MO 63357  
636-433-5410**



**WARNING!**

**This product has NO WARRANTY unless:**

**1. It has been purchased from an **Authorized** or **ViP FASS Dealer**. If in doubt, check [www.FASSRide.com](http://www.FASSRide.com).**

**2. It is registered within thirty (30) days of purchase.**

**Other conditions may apply. Please see full warranty information.**

***NOTE:* Warranty is **void** if product was purchased below FASS website advertised pricing.**

**ATTENTION!**

**Before you begin installation**

**Register for your Warranty ONLINE at**

**<https://www.fassride.com/register-a-warranty/>**

**No online access, call our TECH Support at**

**1-866-769-3747**

# FOLLOW THESE STEPS TO ENSURE A SIMPLE, CORRECT INSTALLATION OF YOUR NEW TITANIUM FUEL SYSTEM

## ATTENTION:

**Be sure to identify the proper FASS System and fuel line configuration. For help, our product finder can be found at [www.FASSride.com](http://www.FASSride.com). Follow the instructions to see fuel line detail.**

- 1** Be sure the serial number on this installation manual matches that on the outside of the box.
- 2** Pay close attention to ALL WARNINGS
- 3** Read all instructions before starting installation of this product.
- 4** Inventory the package components. Notify the place of purchase immediately of any parts missing or damaged.
- 5** The installation recommendations contained herein are guidelines. Use good judgment and take into consideration your vehicles' accessories.
- 6** For best results in accuracy and efficiency (due to training, communication, and our relationship with our dealer network), we recommend a VIP FASS dealer for the installation. They are prepared to install the FASS fuel pumps with the most efficiency. If a situation or problem arises during the installation, the dealer is prepared to handle it. Diesel Performance Products, Inc. is not responsible for any installation mistakes.
- 7** If you have any questions or concerns that cannot be addressed with your dealer, email or call FASS.

---

**If any installation procedure is uncertain, contact FASS technical support.  
Call customer service at 636-433-5410,  
or send us an e-mail: [techsupport@FASSride.com](mailto:techsupport@FASSride.com)  
with the following information:**

---

Your name, address and daytime phone number  
Model **(ND-TSP-DO8-250G)** or **(ND-TSP-DO8-290G)**  
Serial Number  
Last 6 digits of vehicles' VIN

Date of purchase  
Nature of Your Concern  
Serial number .....



## INSTALLATION MANUAL

### **ND-TSP-D08-250G or ND-TSP-D08-290G**

(Installation Videos are available at [www.fassride.com](http://www.fassride.com))

#### **Recommended Application**

**ND-TSP-D08-250G:** Cummins 1998.5 - 2004 with super extreme horsepower modifications

**ND-TSP-D08-290G:** Cummins 1998.5 - 2004 with super extreme horsepower modifications

**NOTE: THIS KIT MAY ALSO BE USED ON 1998.5-2004 CUMMINS WITH IN-TANK LIFT PUMP MODIFICATIONS**

1. **Read all instructions before starting installation of this product!**
2. **Installing the improper FASS Pump can cause severe engine damage.**
3. **Secure vehicle from ROLLING!**
4. **Cab and Chassis may require modifications**
5. **Consult vehicle's manufacturers' instructions concerning the electrical system before attempting any electrical connections.**
6. **Be sure that the serial # on this installation manual matches that of the outside of the box.**
7. **Flush and clean all brass fittings and fuel line from debris.**
8. **Keep debris from entering the internals of the system during installation. Getting debris in the water separator nipple can lock up the motor. If the motor does lock up from debris call FASS for technical assistance.**



9. **Wear safety glasses when operating power tools such as drills and grinders or when using a punch or chisel.**
10. **Properly secure lines to prevent chaffing.**

**BEFORE STARTING THE INSTALLATION PROCESS LUBRICATE THE BED BOLT WITH WD-40 TO HELP WITH INSTALLATION**



**WARNING!**

**Always be sure to fill the fuel tank to full after a new FASS installation. Failure to do so can result in excessive sound output, or priming issues!**

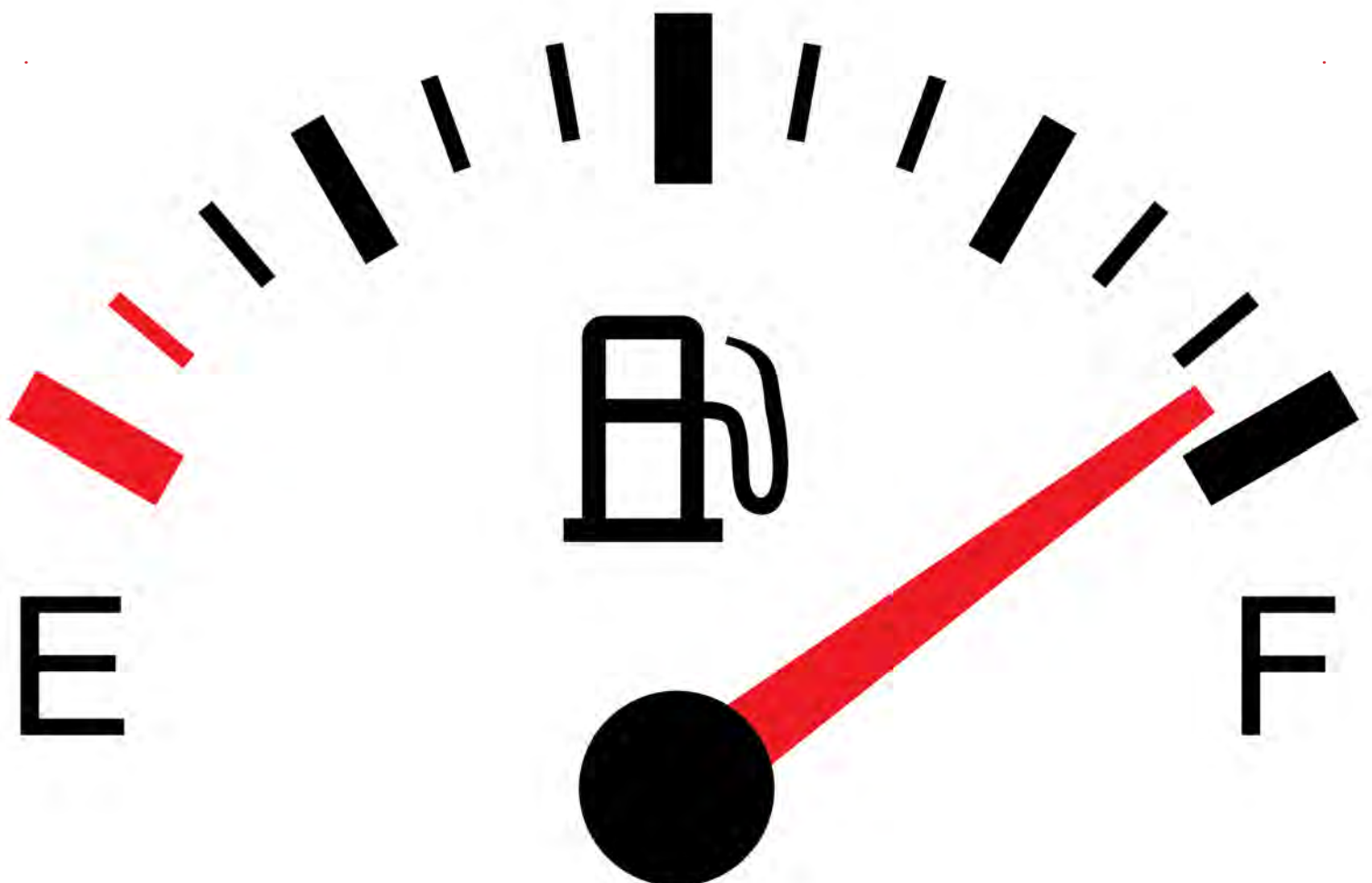

### **SIGNATURE SERIES PLUS**

**250 GPH or 290 GPH**

**16-18 psi (Approximately)**

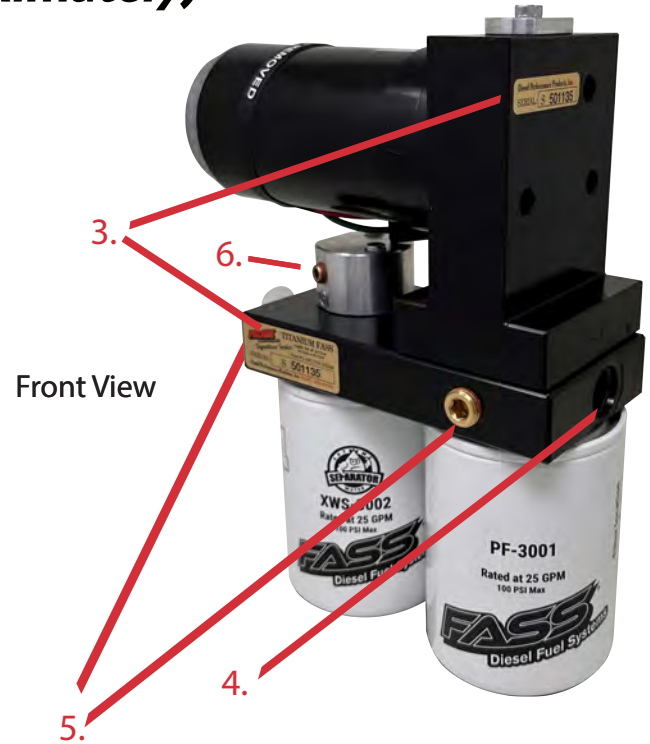

#### **PUMP GUIDE:**

- 1. "E" To Engine**
- 2. "R" Return to Tank**
- 3. Serial Number**
- 4. "T" Fuel Inlet**
- 5. Electric Heater Ports**
- 6. "G" Gauge Port**

#### **INSTALLATION GUIDE:**

- Step 1. Install Electrical Harness**
- Step 2. Prep the FASS**
- Step 3. Mount the FASS**
- Step 4. Fuel Line Supply**
- Step 5. Review Installation**

**SIGNATURE SERIES PLUS**

**250 GPH or 290 GPH**

**16-18 PSI (Approximately)**

**Note: Going over 30 PSI WILL void warranty.**

***NOTE: WARRANTY MAY BEVOID IFSILICONE  
BAND IS REMOVED FROM MOTOR!!***

***The silicone band is in place to retain motor wires,  
preventing damage to the electric motor.***





# CONTENTS

**NOTE:** Owner's Manual available for download on our website,  
[www.FASSride.com](http://www.FASSride.com)



**WH-1006-3**



**MP-9021-ND**



**FL-1002-BK x16'**



**FL-1058-BK x3"**

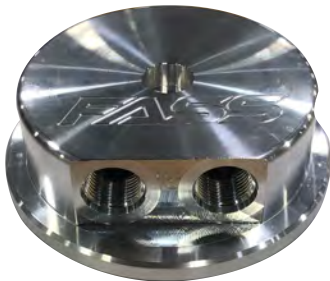

**SP-5501**



**SC-5501**



**PFB-2002**



**PBR-2001**

# MOUNTING PACKAGE CONTENTS



TWO (2)  
PL-1005-BK



AN-10-ORB-10-BK



AN-8-ORB-10-BK



PL-2058-BK



TWO (2) RING TERMINAL

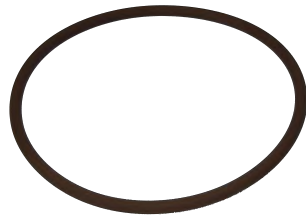

OR-350VITON



O424860



SHCS 3/8\"-16x2\"



PL-2003-BK



PL-10-ORB-10-BK



PL-8-ORB-10-BK



DIPF-1003



46260



THREE (3) HEX BOLT  
1/4\"-20x13/4\"

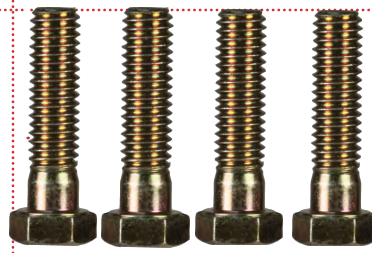

FOUR (4) HEX BOLT  
3/8\"-16x11/2\"



FOUR (4) LOCKING  
NUT 3/8\"



FOUR (4) 3/8\" WASHERS



THREE (3) WA-1001D



46044

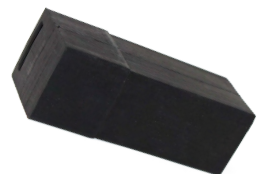

RELAY COVER

## MOUNTING PACKAGE CONTENTS

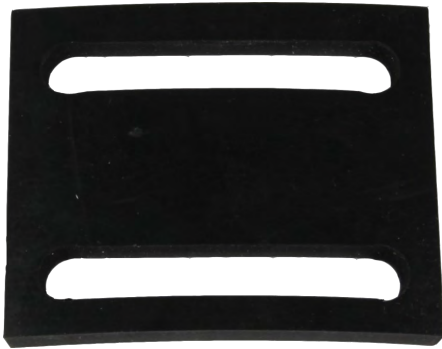

**RS-2002**

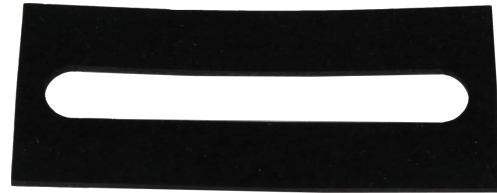

**RS-2001**



**CABLE TIES**



**ST-1005P**



**DIELECTRIC GREASE**



**TWO (2)  
OR-017**



**OR-030**

***NOTE: THESE SPARE BASE O-RINGS ARE INCLUDED WITH THE KIT IN THE EVENT OF A PINCHED O-RING DURING ASSEMBLY***

**STEP 1:**  
**INSTALL ELECTRICAL HARNESS**

The installation of the electrical harness is done first, allowing power to be applied to the pump for lubrication purposes later in the installation.

**NOTE: USE SUPPLIED DIELECTRIC GREASE  
SPARINGLY ON ALL ELECTRICAL  
CONNECTIONS! BE SURE TO GREASE RELAY  
PIGTAIL!**



**STEP 1:**  
**INSTALL ELECTRICAL HARNESS**

The installation of the electrical harness is done first, allowing power to be applied to the pump for lubrication purposes later in the installation.

***Install the Relay Cover onto the relay on the FASS harness.***

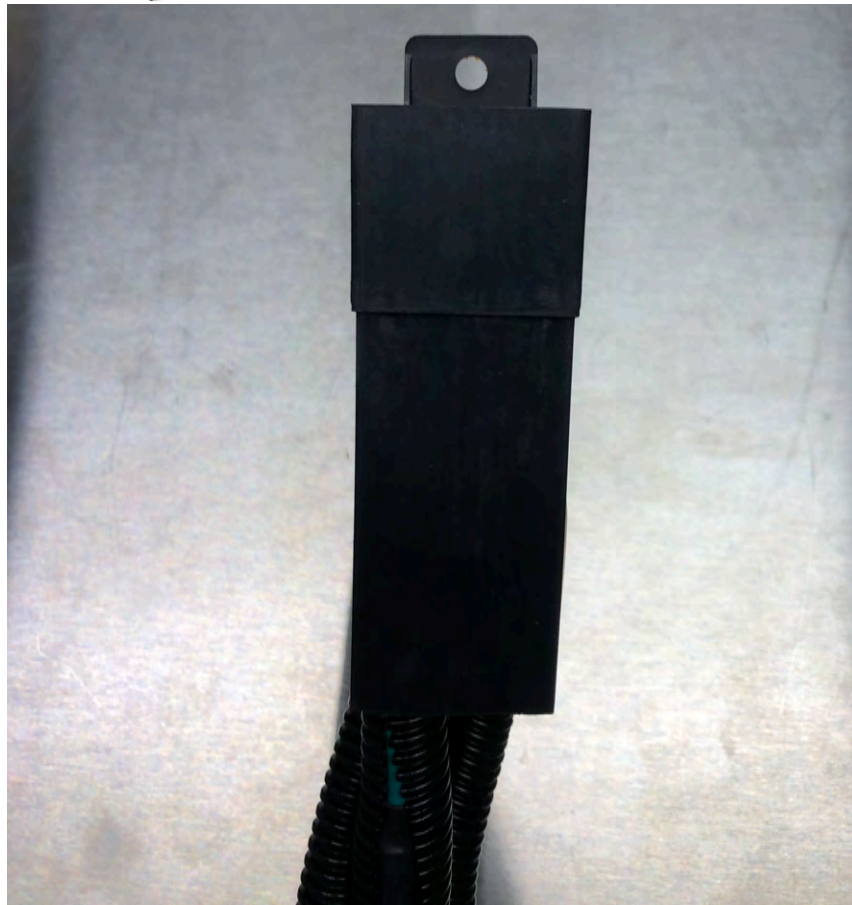
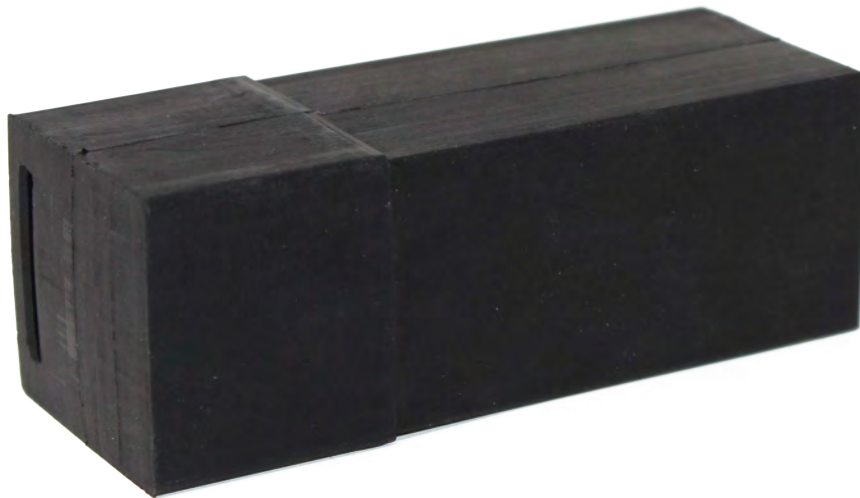

**STEP 1:**  
**INSTALL ELECTRICAL HARNESS**

The installation of the electrical harness is done first, allowing power to be applied to the pump for lubrication purposes later in the installation.

**NOTE: BE SURE TO INSTALL THE SUPPLIED  
30 AMP FUSE INTO THE FASS WIRING  
HARNESS!!**



## **STEP 1:** **INSTALL ELECTRICAL HARNESS**

*The installation of the electrical harness should be completed first. This will allow power to be applied to the pump during installation.*

- A.** Using wire stripping tool, remove excess insulation off the add-a-fuse and the WH-1006-3.



## **STEP 1:** **INSTALL ELECTRICAL HARNESS**

**B.** Place wire from 46044 and single red bare wire from WH-1006-3 into butt connector. Using crimping tool connect 46044 and WH-1006-3 with butt connector. Install 46260 to 46044 top slot (opening that is near the spade).

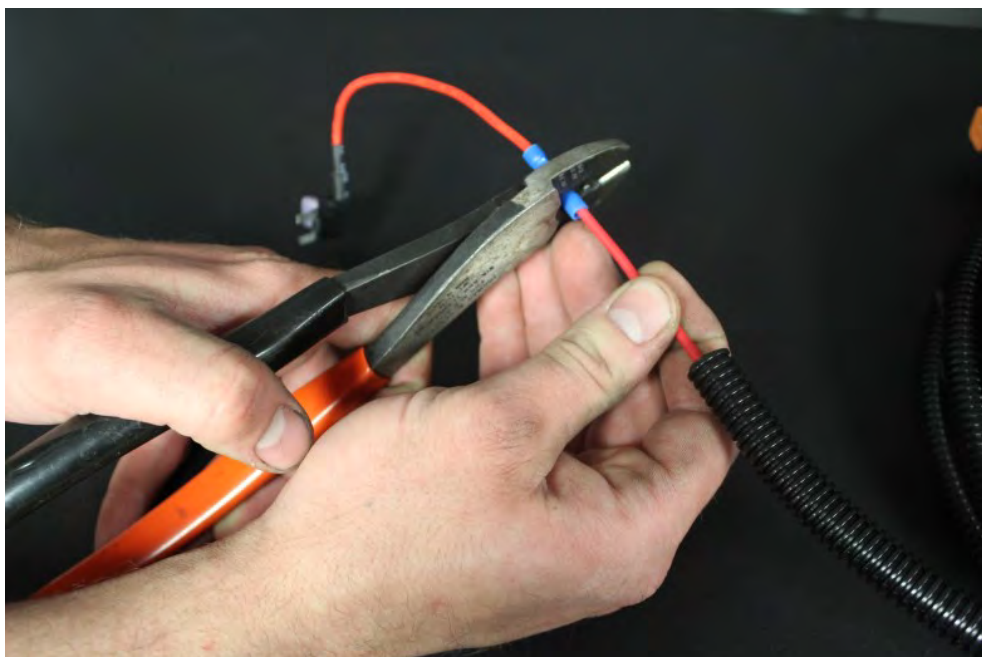
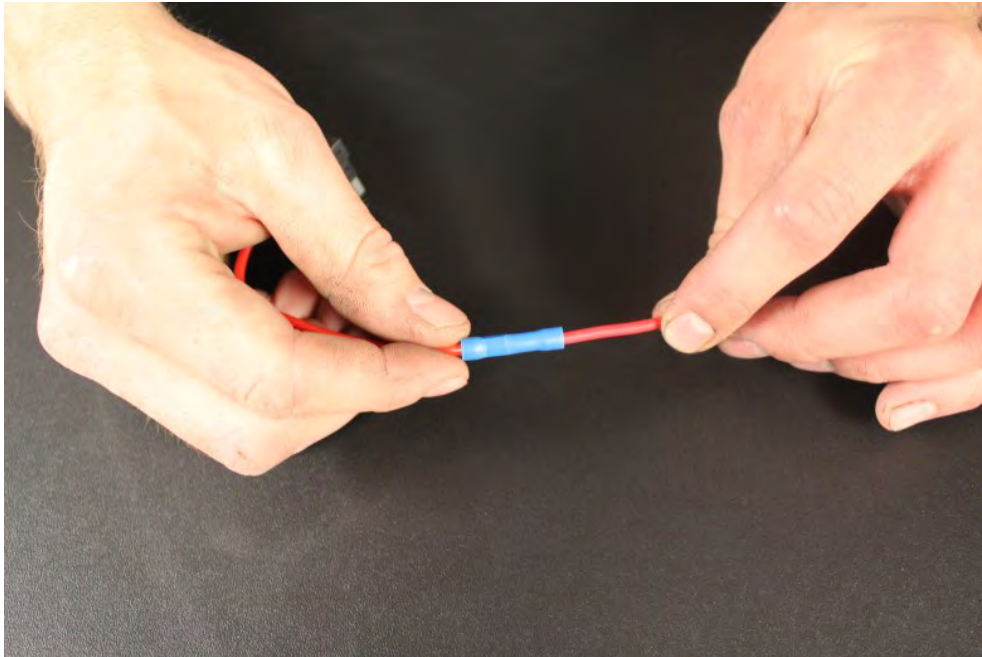



## **STEP 1:** **INSTALL ELECTRICAL HARNESS**

**C.** Crimp the ring terminals to the red and green wires of the WH-1006-3 Wire Harness. Attach red wire to the positive terminal of the battery and the green terminal to the negative terminal. **The use of a corrosion preventative on electrical connections is recommended.**

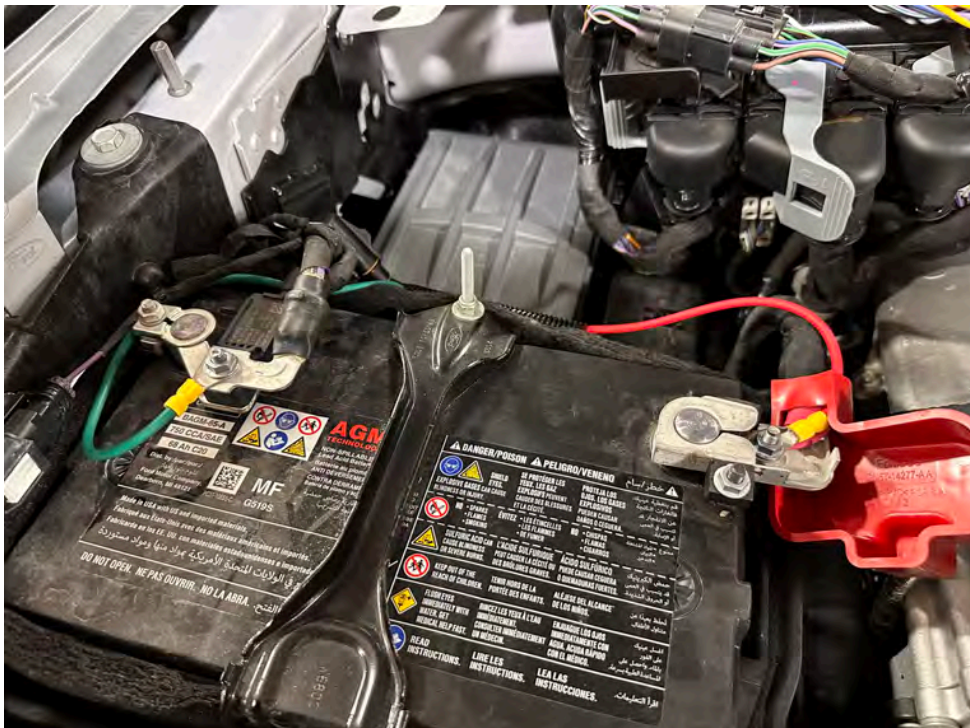
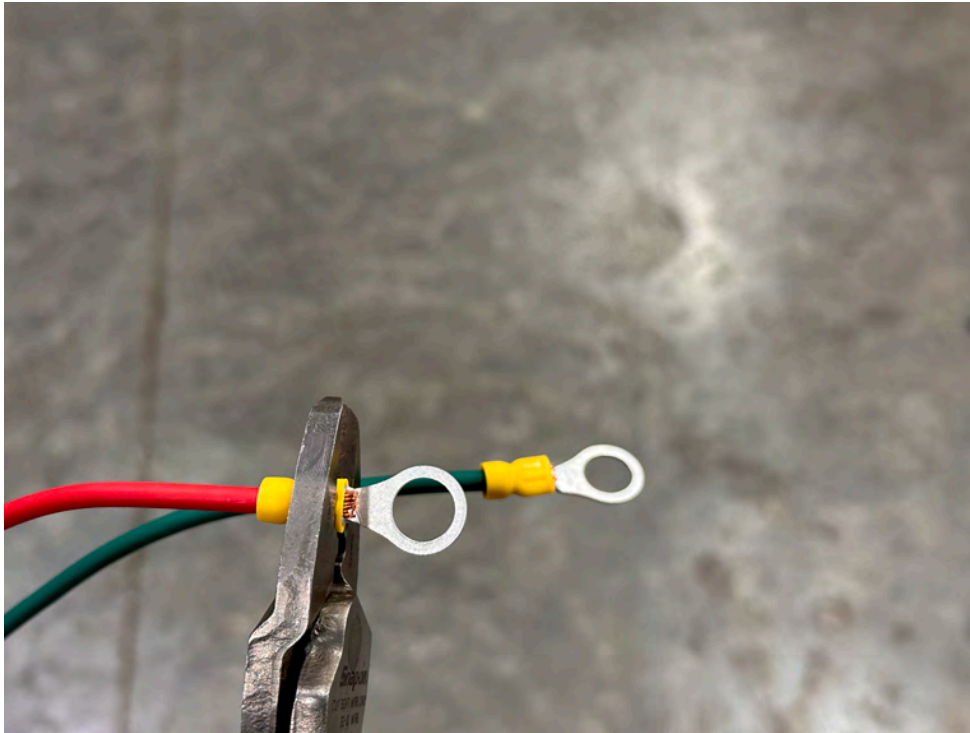

## **STEP 1:** **INSTALL ELECTRICAL HARNESS**

**D.** Secure relay and fuse in an upright position, as shown, to prevent moisture from entering. Di-electric grease may be applied to prevent corrosion.

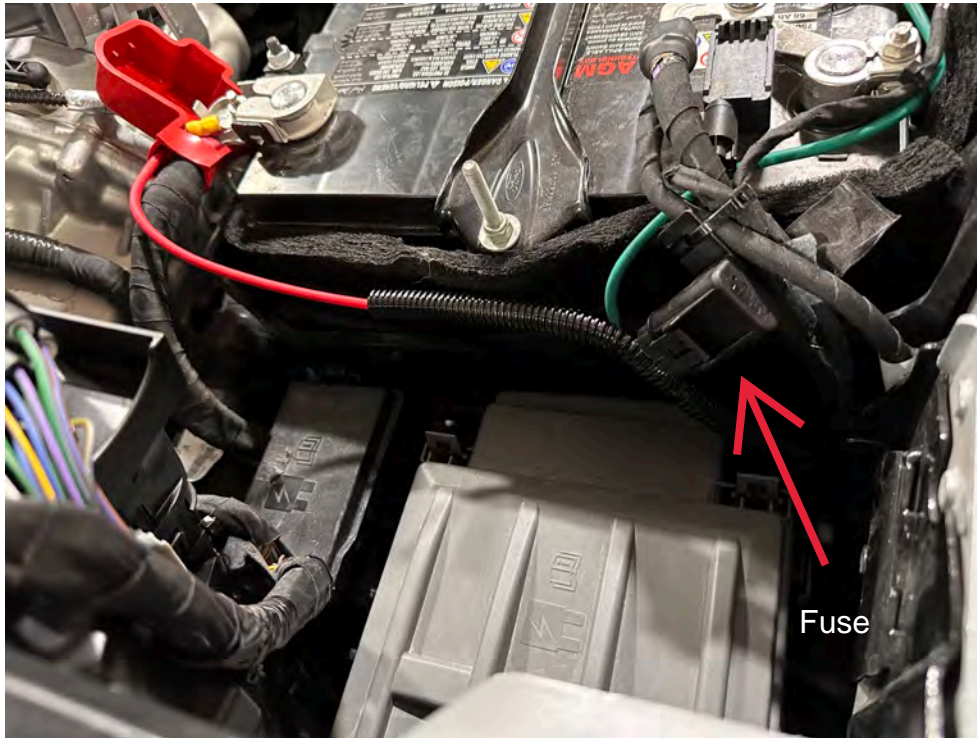

## **STEP 1:** **INSTALL ELECTRICAL HARNESS**

**E.** If fuse panel is located in the cab it will be necessary to guide the single red wire from the relay through the fire wall grommet to access the fuse panel.



## **STEP 1:** **INSTALL ELECTRICAL HARNESS**

F. Locate fuse box under hood and select ignition hot fuse. Remove fuse and put Add-A-Fuse in place. Install fuse previously removed. **The use of a corrosion preventative on electrical connections is recommended.**

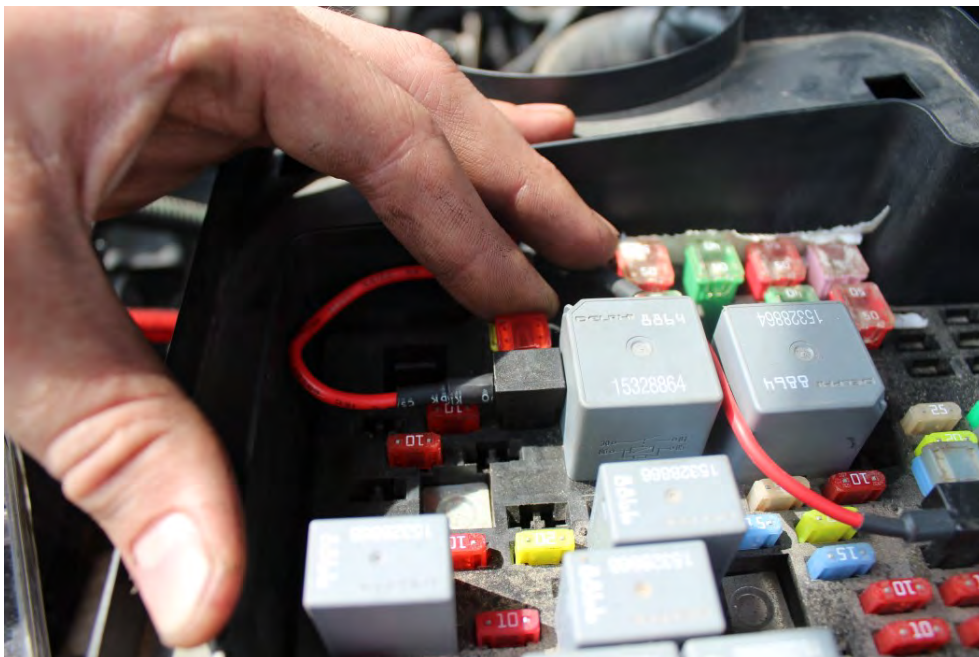
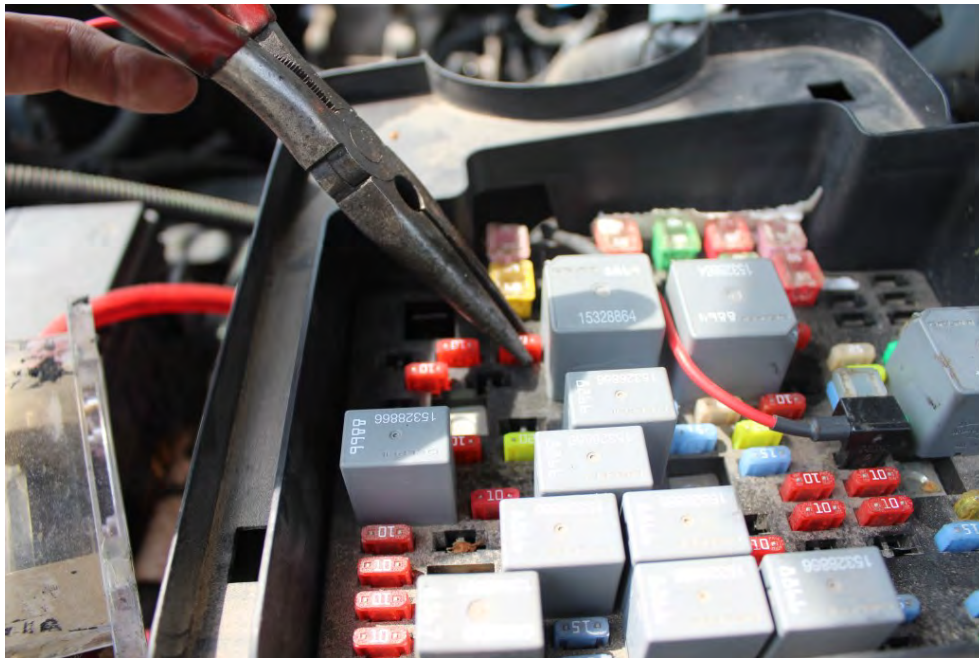

## ***STEP 1:*** ***INSTALL ELECTRICAL HARNESS***

**G.** Route WH-1006-3 wire harness along frame rail to mounting location of pump.  
Completion of this step will be addressed in the Mounting Step 3.

**NOTE:**

**ATTENTION:** While installing fittings into Titanium pump  
**DO NOT** Apply side pressure to draw tube of pump

**PROPER**



**IMPROPER**

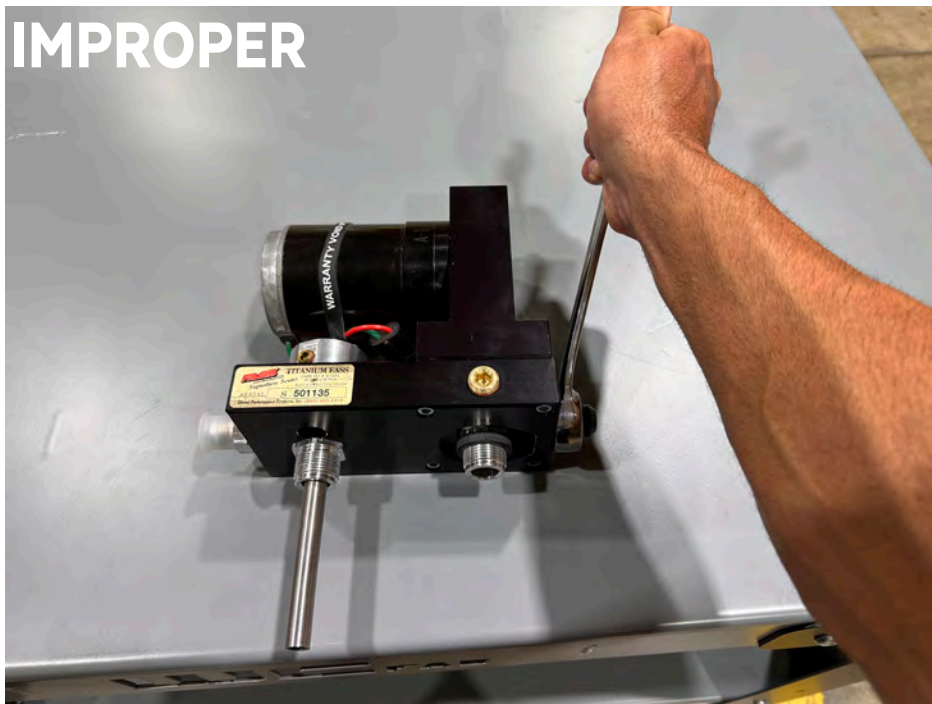

## **STEP 2:** **MOUNT FUEL SYSTEM**

**NOTE: Before installing fittings make sure to inspect for burs or flare imperfections. When cutting fuel line make sure to blow out line to keep debris from moving forward..**

**A.** Install AN-8-ORB-10-BK into the "E" port and AN-10-ORB-10-BK into the "T" port of the FASS, tighten accordingly.



## **STEP 2:** **MOUNT FUEL SYSTEM**

**B.** For fitting purposes. Secure PBR-2001 to pump assembly lightly with (3) 1/4"-20x1 3/4 bolts and (3) WA-1001D. Assembly will be used in future steps for correct fitting of brackets. (Note: Bracket may-be flipped to accommodate your application.)

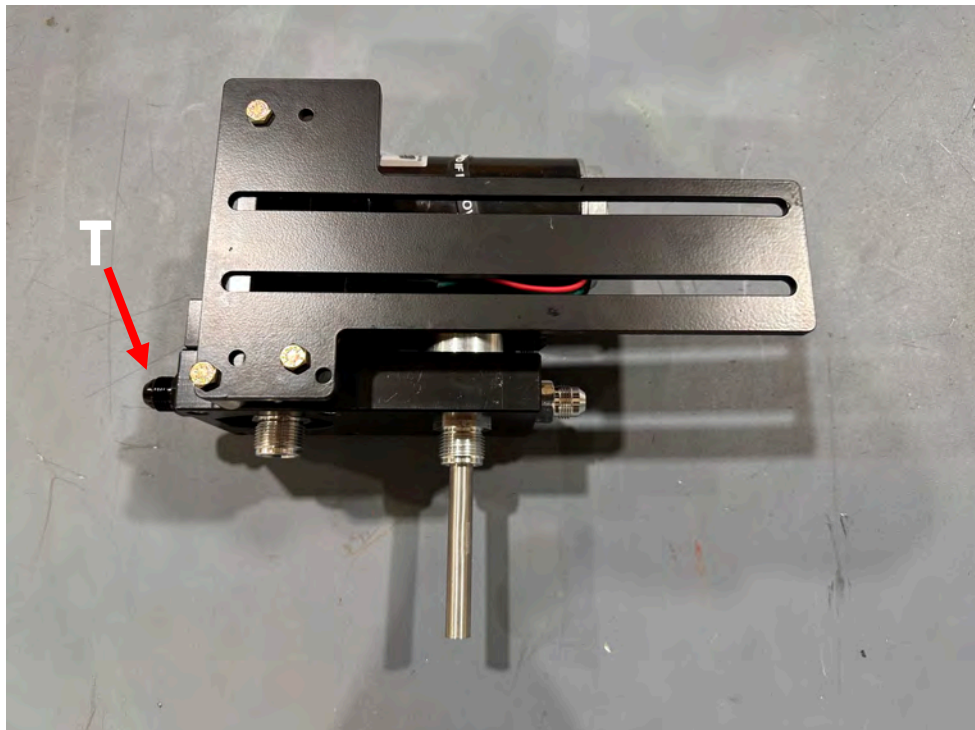
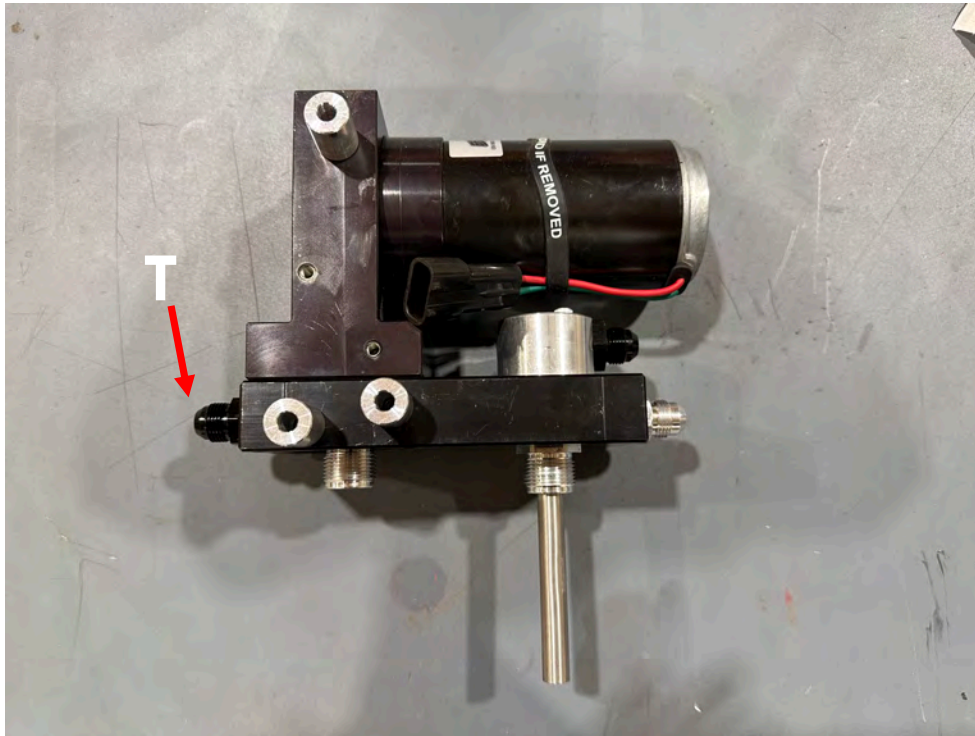



## **STEP 2:** **MOUNT FUEL SYSTEM**

**C.** Unbolt driver side front bed bolt from bed retain bolt for future use. Align RS-2001 with PFB-2002.



## **STEP 2:** **MOUNT FUEL SYSTEM**

D. Secure PFB-2002 and RS-2001 with bed bolt in previous step.



## **STEP 2:** **MOUNT FUEL SYSTEM**

E. Position the PBR-2001 to the PFB-2002 pump assembly at the mounting location and check for fit. Once location is established mark location for mounting in next step.

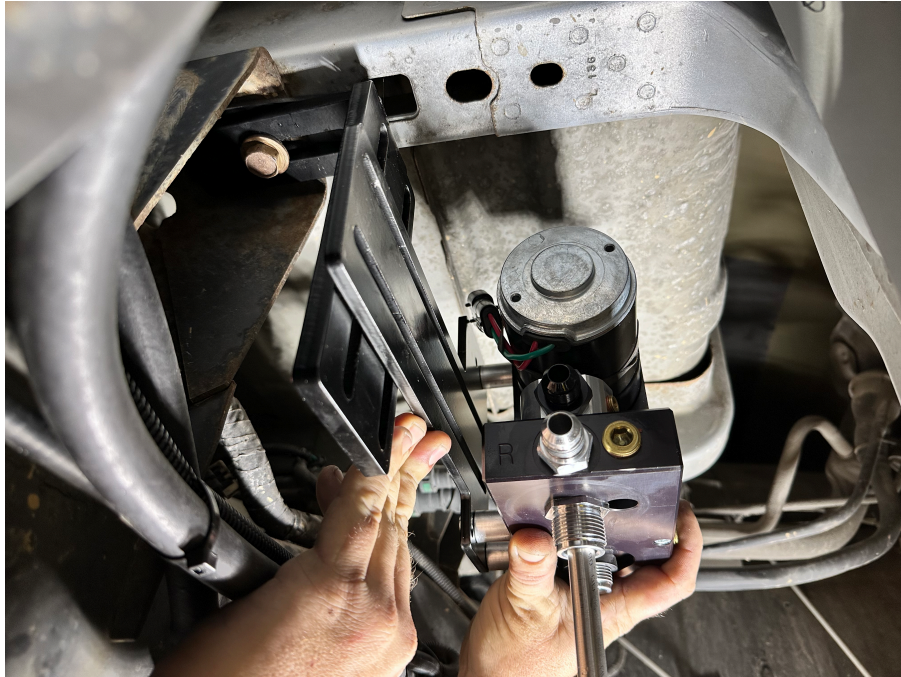

## **STEP 2:** **MOUNT FUEL SYSTEM**

F. Assemble the FASS pump bracket PBR-2001 using the RS-2002 spacer between PFB-2002 and PBR-2001 bracket with 4-3/8 bolts, nuts, and washers.

**Note: Torque bolts not flange nut.**

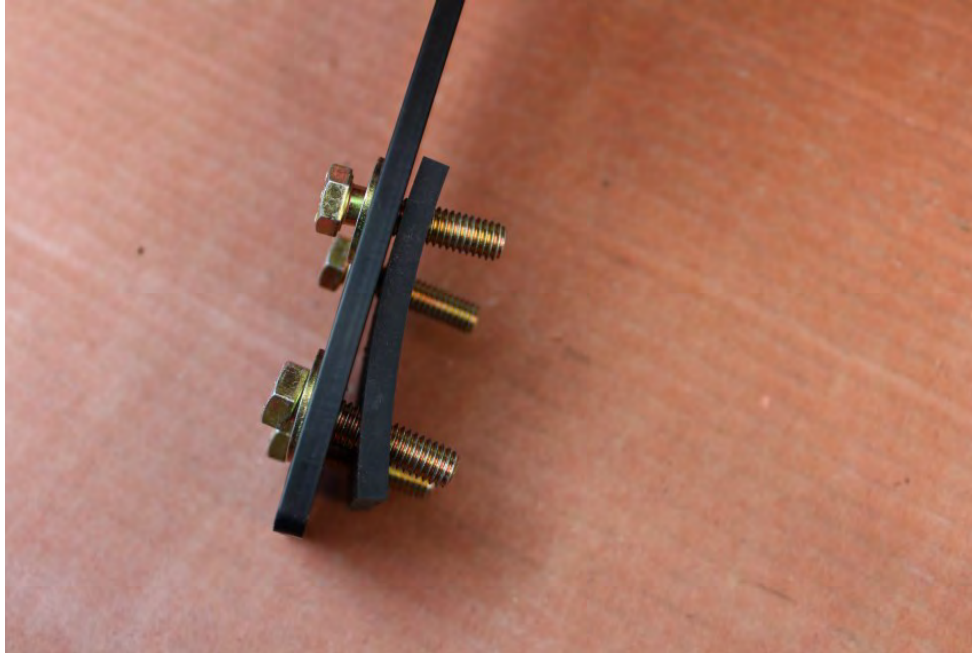

## **STEP 2:** **MOUNT FUEL SYSTEM**

**G.** Once secure use 3-1 1/2 bolts and 3-WA-1001D spacers to mount the pump to the bracket.

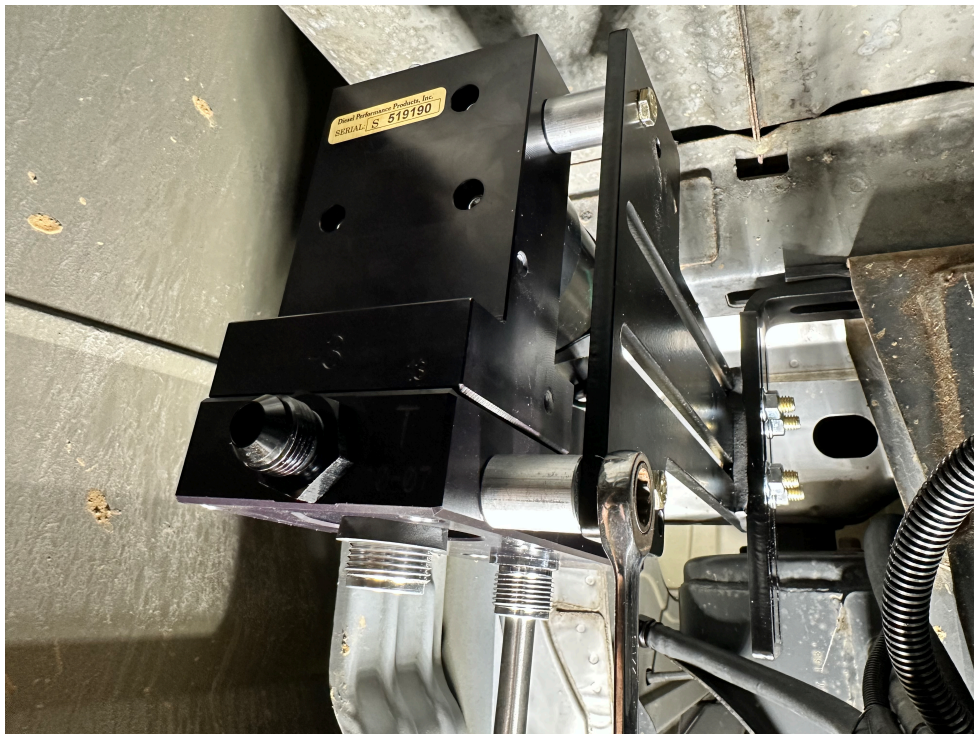
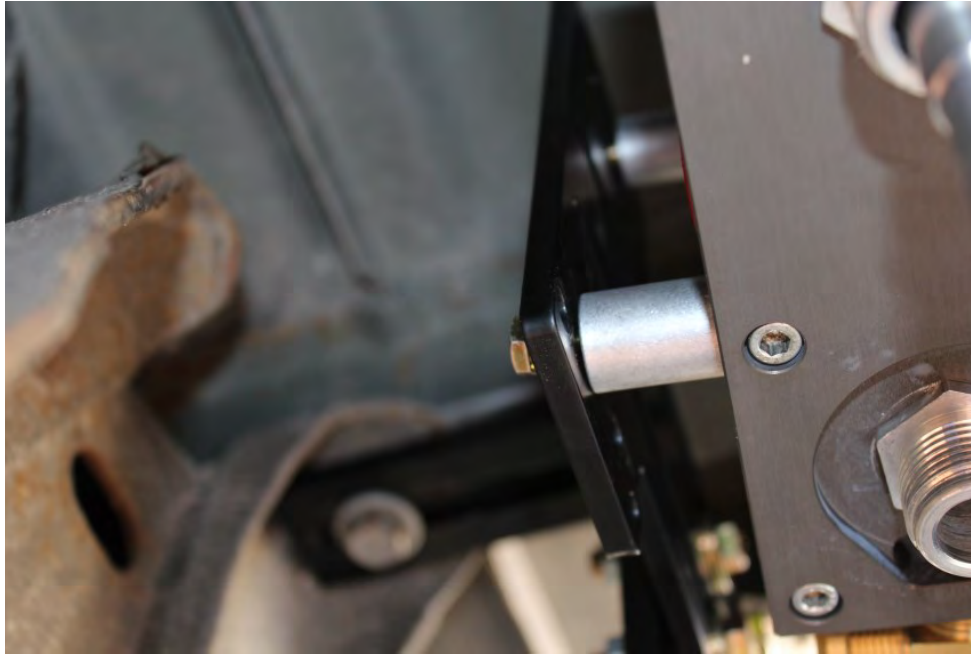

## **STEP 2:** **MOUNT FUEL SYSTEM**

**H.** Connect female plug of the FASS harness into pump. Turn key to “on”. With pump operating (you may have to bump the starter), turn pump over, liberally spray WD-40 (or equivalent) into water separator nipple lubricating Gerotor.

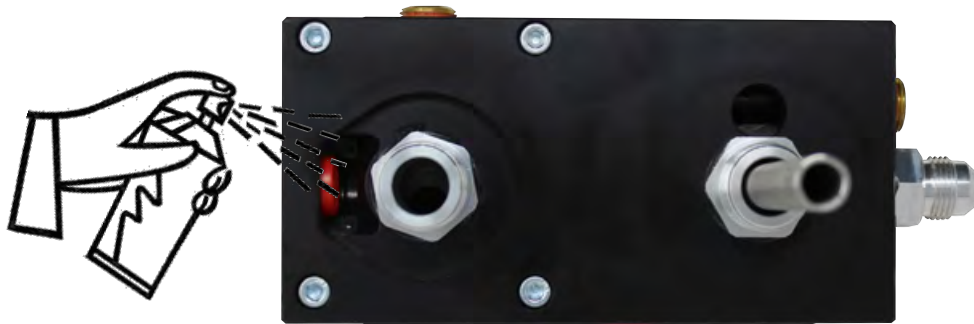

## **STEP 2:** **MOUNT FUEL SYSTEM**

- I. Apply motor oil to gasket located on filters. Attach to system and hand tighten.



**Extreme Water Separator -  
Install XWS-3002 on side of  
pump with draw tube in the  
middle of the filter nipple.**



**Particulate Filter -Install PF-3001 on  
filter nipple without the draw tube.  
Make sure to insert O-Ring provided  
on nipple.**



**Note: O-Ring must be put back on suction side of pump. Failure to do so can result in priming issues, cavitation or pressure losses.**

## **STEP 3:** **SUMP INSTALLATION**

**A.** Locate the lowest point of the fuel tank, which is typically below the factory fuel module. On some applications there is a dimple you can use for a center point reference and it has the flattest surface for sealing the sump.





## **STEP 3:** **SUMP INSTALLATION**

**B.** Using the center point, drill a small hole to drain the remaining fuel. Recommend having a container large enough to retain the remain fuel. Allow fuel to drain completely.



## **STEP 3:** **SUMP INSTALLATION**

- C. Using a 3-3/4" hole saw drill the center point previously marked or notated.



## **STEP 3:** **SUMP INSTALLATION**

D. Deburr hole and remove all shavings.



## **STEP 3:** **SUMP INSTALLATION**

E. Install SC-5501 into fuel tank positioned as shown.

**NOTE: THIS SIDE FACES SP-5501**

**NOTE: THIS SIDE FACES THE INSIDE OF TANK**



## **STEP 3:** **SUMP INSTALLATION**

F. Using grease, install OR-350VITON into the groove of SP-5501.



## **STEP 3:** **SUMP INSTALLATION**

**G.** Install the supplied 3/8-16x2" SHCS through 0424860 and hand tighten SP-5501 into place.



**NOTE: 0424860 MUST BE INSTALLED BEFORE TIGHTENING SP-5501 INTO PLACE**



## **STEP 3:** **SUMP INSTALLATION**

H. Rotate SP-5501 to your desired position and torque the 3/8-16x2" SHCS to 12 FT/LBS .

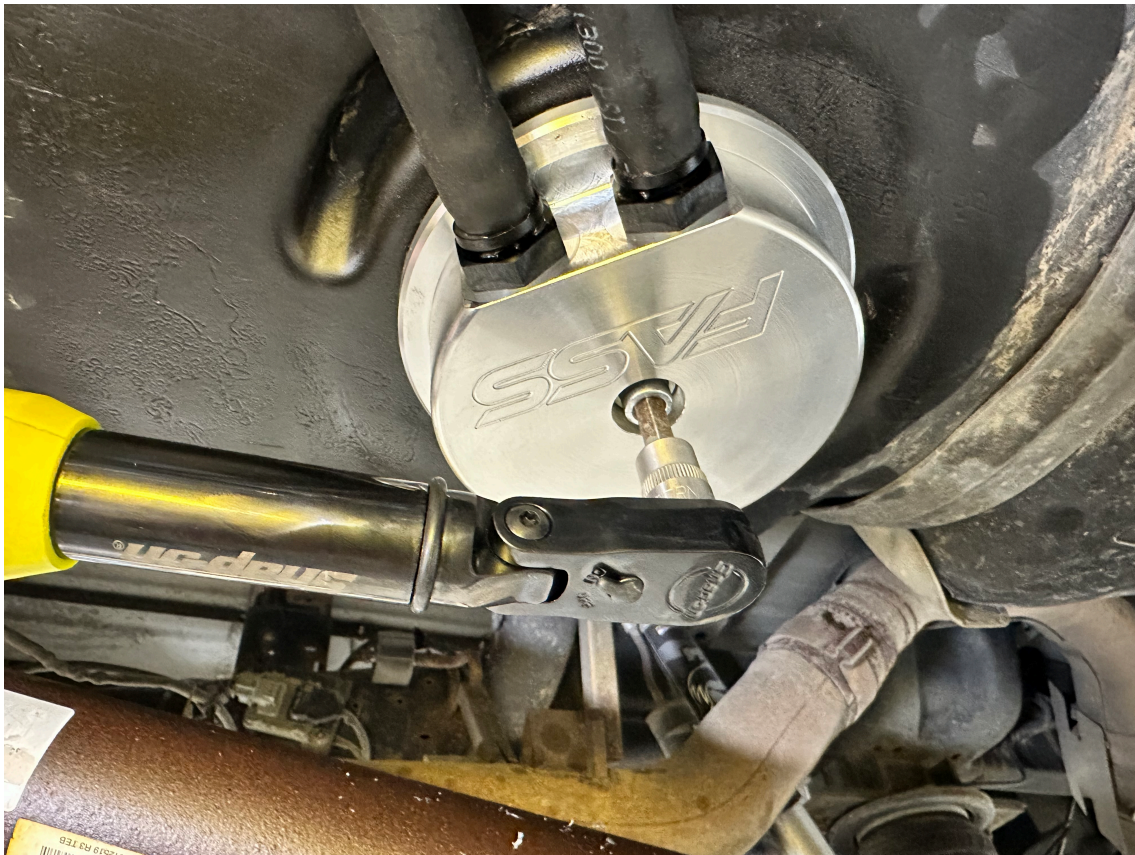

**NOTE: RETURN PORT AND POCKET**



**NOTE: SUPPLY PORT AND POCKET**

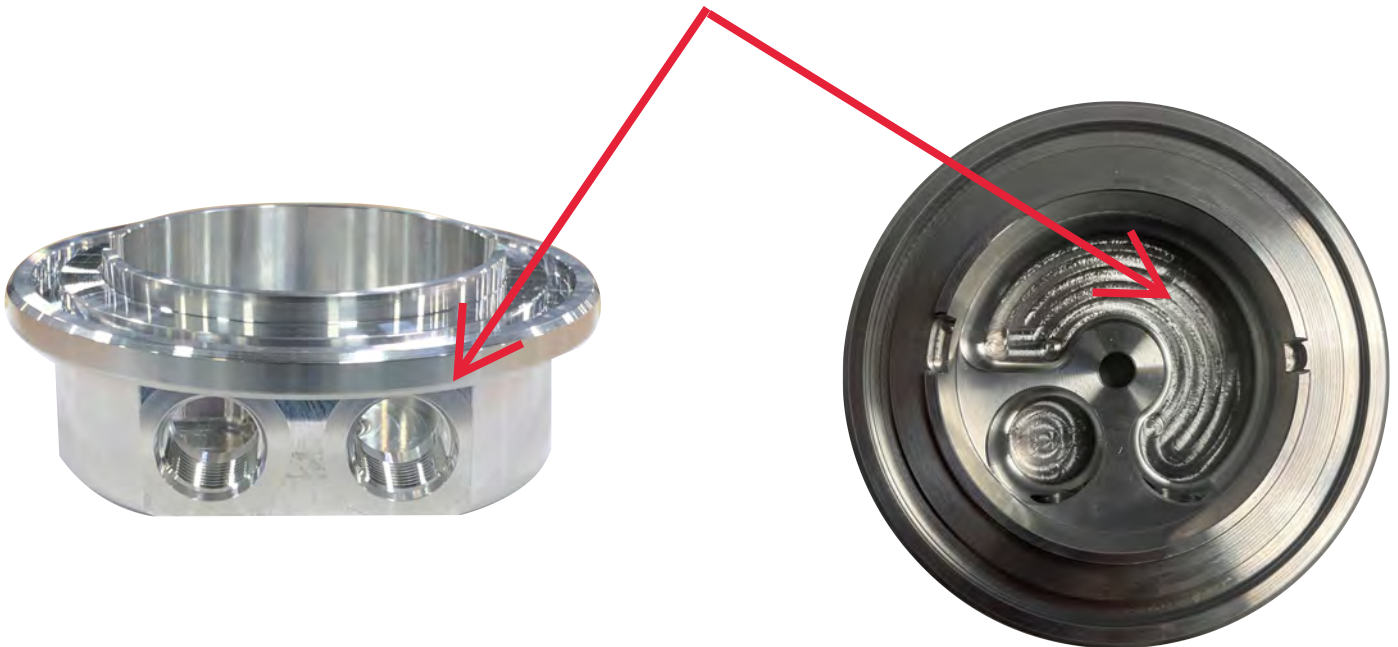



## **STEP 3:** **SUMP INSTALLATION**

- I. Install PL-8-ORB-10-BK into the return port of SP-5501 and tighten accordingly.



**STEP 3:**  
**SUMP INSTALLATION**

J. Install PL-10-ORB-10-BK into the suction port of SP-5501 and tighten accordingly.



**STEP 4:**  
**INSTALL FUEL LINE**

**A.** Using grease, press the fuel return line to the return port fitting of SP-5501. Route the fuel line to the "R" port on the FASS, then install PL-1005-BK into FL-1002-BK using grease. Install PL-1005-BK onto the FASS return fitting and tighten accordingly.

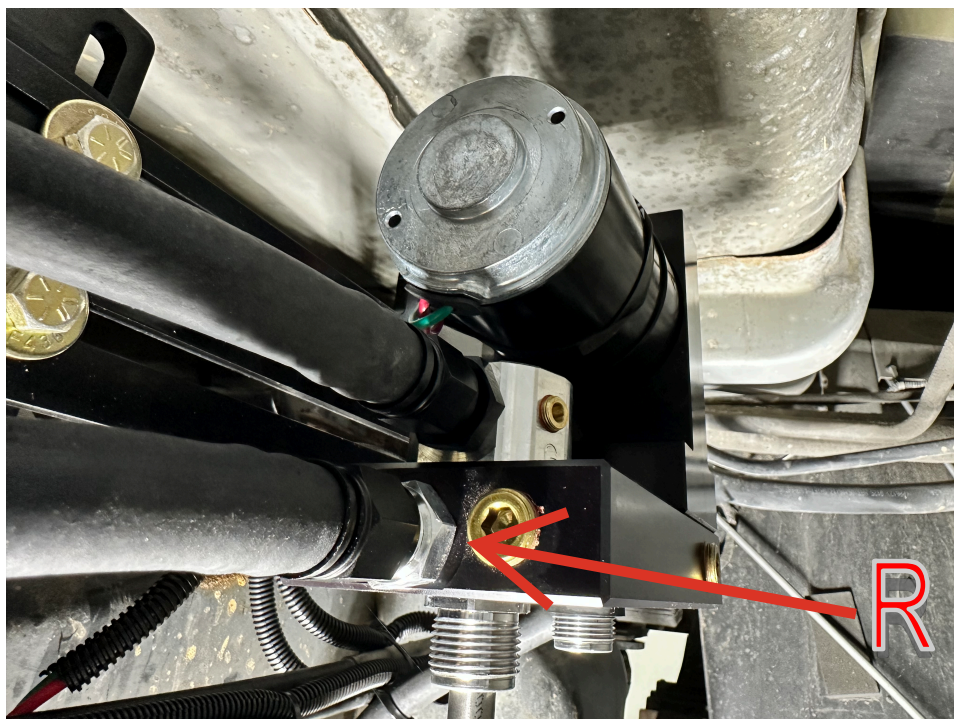

## **STEP 4:** **INSTALL FUEL LINE**

**B.** Using grease, press the suction line onto the PL-10-ORB-10-BK in the suction port of the sump. Route FL-1058-BK to the "T" port of the FASS and trim to length. Press PL-2058-BK into FL-1002-BK using grease, install onto AN-10-ORB-10-BK and tighten accordingly.

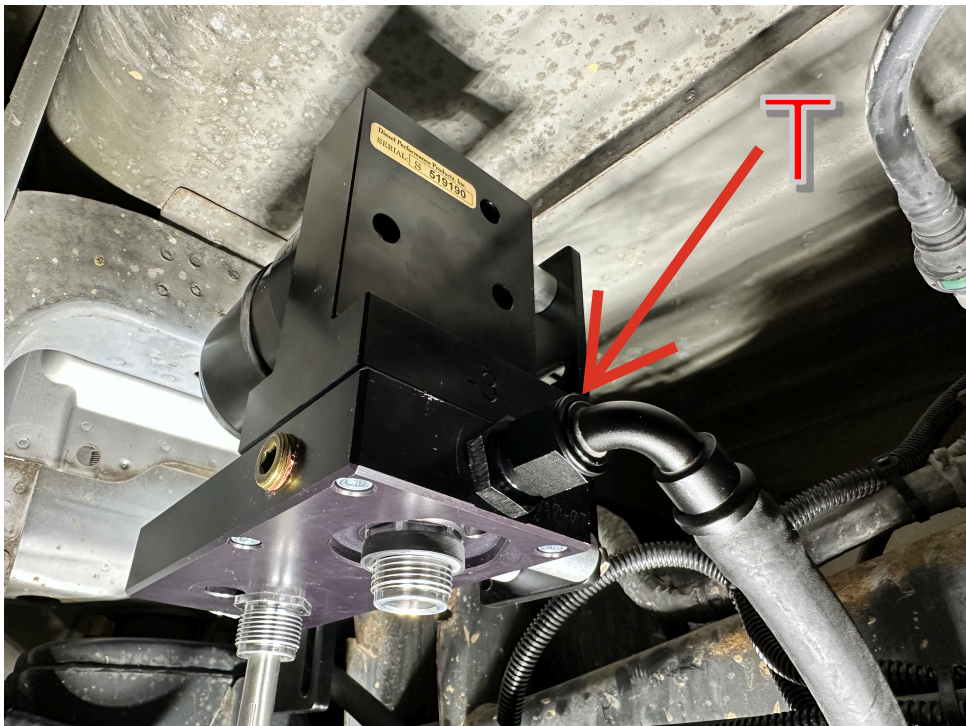

**STEP 4:**  
**INSTALL FUEL LINE**

**Caution: DO NOT use sealant on AN fittings**

C. Insert PL-1005-BK into the remaining fuel line using oil. Connect to the 'E' port of the FASS system and tighten accordingly. Route this fuel line to the injection pump.

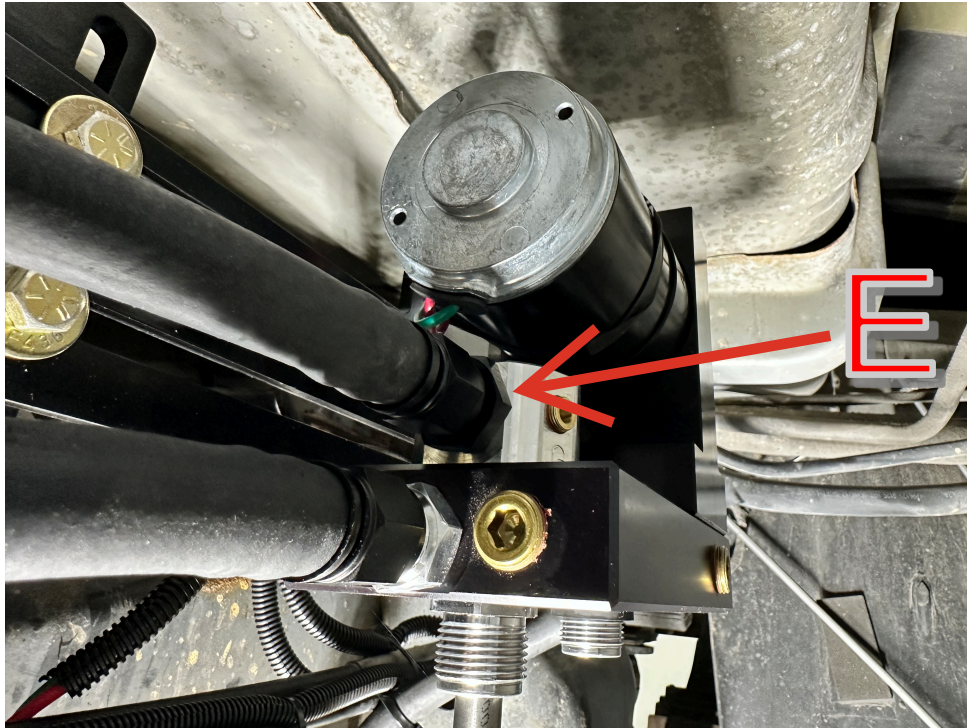

**STEP 4:**  
**INSTALL FUEL LINE**

**2003 - 2004 CP3 (Injection Pump)**

D. Disconnect factory fuel line from inlet side of the factory injection pump, Install the DIPF-1003 fuel fitting into this inlet port.

(Note: This is where the suction fuel line from the fuel filter enters the injection pump.)



**STEP 4:**  
**INSTALL FUEL LINE**

**1998.5 - 2002 VP44 (Injection Pump)**

D. Disconnect factory fuel line from inlet side of the factory injection pump, Install the DIPF-1003 fuel fitting into this inlet port. (Note: This is where the suction fuel line from the fuel filter enters the injection pump.)



**STEP 4:**  
**INSTALL FUEL LINE**

**2003 - 2004 CP3 (Injection Pump)**

E. Measure and cut fuel line. Insert PL-2003-BK using oil. Install fitting onto DIPF-1003 and tighten accordingly.

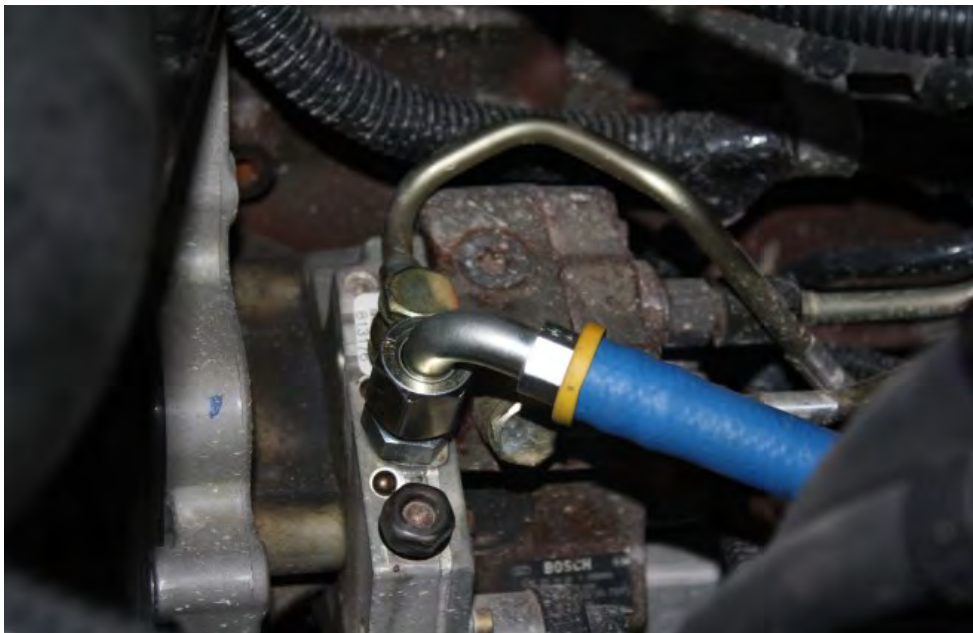



**STEP 4:**  
**INSTALL FUEL LINE**

**1998.5 - 2002 VP44 (Injection Pump)**

E. Measure and cut fuel line. Insert PL-2003-BK 90° Push-Lok fitting using oil. Install fitting onto DIPF-1003. Torque to 18 ft/lbs.



## **STEP 4:** **INSTALL FUEL LINE**

**F.** We recommend putting approximately 5 gallons of fuel in the tank prior to filling the tank to check for fuel leaks. Prime the FASS system and check for leaks. Once you confirm no fuel leaks, the tank can be filled to capacity.



## **STEP 5:** **REVIEW INSTALLATION**

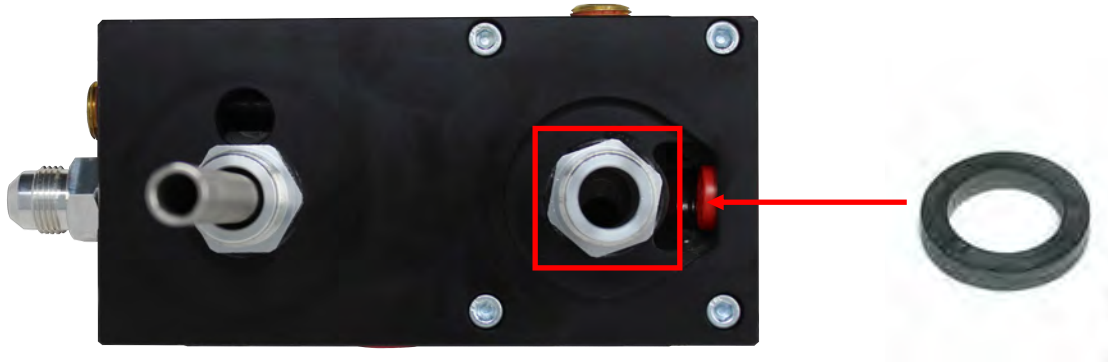

**Note: O-Ring must be put back on suction side of pump. Failure to do so can result in priming issues, cavitation, or pressure losses.**

1. **Blow out any open lines/cover any open ports**
2. **Bolts and fasteners properly tightened?**
3. **Electrical harness and fuel lines secured and properly tightened? Reconnect the battery.**
4. **Has the system been primed?**
  - a. **Turn key to the ignition position, turning on the FASS pump for 15 sec..**
  - b. **Crank engine and allow to run for at least 1 minute.**
5. **Check for leaks.**
6. **Start the engine**
7. **Recheck all fluid and filter connections for leaks**
8. **This pump comes with a 1 Year Manufacturer's Warranty based on the date it has been manufactured. To receive your extended Lifetime Warranty, you have 30 days from date of purchase to send the completed warranty information**



**NOTE:**

**POSSIBILITY FOR CODE P0628!**

**With the removal or disconnection of the factory lift pump, it is possible for code P0628 to occur. This code should not cause a MIL, it will remain stored in the ECM.**



[www.fassride.com](http://www.fassride.com)

(866) 769.3747

## LIMITATION OF LIFETIME WARRANTY

*Disclaimer: To help insure you receive the proper system and customer support at the local level, FASS has a VIP and Authorized Dealer network representing FASS products. This is one reason you must purchase through a dealer to comply with our warranty policies. If you do not, there is no warranty! We recommend you go to [www.FASSride.com](http://www.FASSride.com), click "Find a Dealer", put in their ZIP code, select the type of dealer, and see if the company you purchased from is listed. If they are not, put their phone number in the field below the ZIP code field to see if they are listed. Below these two fields is a list of "Terminated/Unauthorized" dealers. You may want to review this list. If the company is not listed or is on the "Terminated/Unauthorized" list, we suggest you return the product immediately to that dealer and call FASS. We'll recommend you to the nearest dealer.*

*Diesel Performance Products, Inc. (hereafter "SELLER") gives Limited Warranty as to description, quality, merchantability, fitness for any product's purpose, productiveness, or any other matter of SELLER'S product sold herewith. The SELLER shall be in no way responsible for the product's open use and service and the BUYER hereby waives all rights other than those expressly written herein. This Warranty shall not be extended or varied except by a written instrument signed by SELLER and BUYER.*

*When MANUFACTURER receives the "ORIGINAL" PRODUCT REGISTRATION form with a copy of the "BILL OF SALE/SALES RECEIPT" within 30 days of the sale, then the following applies! The Warranty will then and only then be validated to that of which typically accompanies your unit for your specific application from the date of sale or for recommended service life and limited solely to the original purchaser and/or vehicle and parts contained within the product's kit. This warranty does not cover normal wear on consumable items such as but not limited to filters, fuel line, wire harness & etc. The warranty does not cover seized gears due to lack of filtration. Warranty is voided if used with other than diesel fuel. Returned items will arrive prepaid to the place of purchase. Diesel Performance Products, Inc. will repair, without cost, any product found to be defective during the warranty period; parts only, or at its option, will replace such products in exchange for the product. Repair or replacements are warranted for the remainder of the original warranty period. All Warranty claims are subject to approval by Diesel Performance Products, Inc.*

*A Return Material Authorization (RMA) number must be obtained before any product is to be returned to Diesel Performance Products, Inc. for warranty consideration, repair or product return. Requests for product returns must be offset by an equal value order. Return parts must be completed and in resalable condition. No returns after 30 days.*

*The following information is required to obtain a RMA number before returning product:*

*Your Name, Address, and Phone Number's*

*Model and Serial Number (Not Motor Number) Example: Model HD Series, Serial: 00125966 VIN Number of Vehicle*

*Date of Purchase*

*Nature of Problem*

*RMA and Product Serial Number must be on all paperwork and correspondence. Failure to obtain the required information or paperwork will result in \$25.00/item penalty and delay or denial of any warranty claim.*

*Under no circumstances shall the SELLER and/or MANUFACTURER be liable for any labor charged or travel time incurred in diagnosis for defects, removal, or reinstallation of this product, or any other contingent expenses.*

*Under no circumstances shall the SELLER and/or MANUFACTURER be liable for any damage or expenses incurred by reason of the use or sale of any such equipment. This warranty does not apply to products which Diesel Performance Products, Inc. has determined to have been misused or abused, improperly maintained by the user, or where the malfunction or defect can be attributed to the use of non-genuine Diesel Performance Products, Inc. parts.*

*IN THE EVENT THAT THE BUYER DOES NOT AGREE WITH THIS AGREEMENT: THE BUYER MAY PROMPTLY RETURN THIS PRODUCT, IN A NEW AND UNUSED CONDITION, WITH A DATED PROOF OF PURCHASE, TO THE PLACE OF PURCHASE WITHIN THIRTY (30) DAYS FROM DATE OF PURCHASE FOR A FULL REFUND LESS SHIPPING.*

*THE INSTALLATION OF THIS PRODUCT INDICATES THAT THE BUYER HAS READ AND UNDERSTANDS THIS AGREEMENT AND ACCEPTS ITS TERMS AND CONDITIONS.*