



TITANIUM SIGNATURE SERIES INSTALLATION MANUAL

ALL 1/2" FUEL PORTS



Powerstroke 6.7L

**Bypassing the Factory Lift Pump*
Standard Pickup Truck*

2017-2022

APPLICATION:

- ND-TSP-F18-180F-140G
(140GPH @ 65PSI)
- ND-TSP-F18-250F-220G
(220GPH @ 65PSI)
- ND-TSP-F18-290F-240G
(240GPH @ 65PSI)

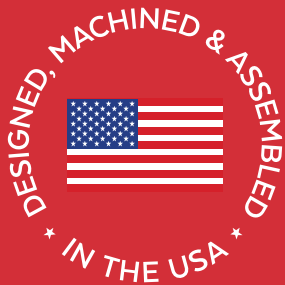

**Note: Cab and Chassis
may require modifications**



www.fassride.com

(866) 769.3747

Thank you for choosing FASS, from Diesel Performance Products, Inc.

FASS specializes in building extremely high-quality fuel products. We have earned an unsurpassed reputation for excellence in our industry by using only the highest-quality American-made components. In order to support our American workers and our American economy, more than 98+ percent of our products are manufactured completely in the United States.

Of course, that dedication to excellence comes at a price, but it is important to remember that price does not dictate quality-quality dictates price! We will never compromise by using cheaper, foreign-made components, like so many of our competitors do.

Customer satisfaction is our top priority and we strive always to provide outstanding customer service. Our Research and Development department, in conjunction with our Dealer Support Department, continually searches for ways to improve quality, expand our product line, and provide superb support. Our exclusive ViP Network ensures that customers receive the proper products and support at the local level. The extended lifetime warranty is only available on products purchased from the network. There is no warranty on products not purchased outside the network.

IMPORTANT:

In order to qualify for the lifetime extended warranty, your product registration form and proof of purchase from an authorized dealer must be submitted to FASS Fuel Systems within 30 days of purchase. Failure to comply will void the warranty. We have the right to deny any warranty believed to be false, altered or purchased through an unauthorized or terminated dealer. A current list of authorized dealers can be found on our website, FASSRide.com.

The complete conditions of the Limitation of Warranty can be found in the back of this manual, and FASSRide.com.

**For more information,
contact Technical Support:
Diesel Performance Products, Inc.
16234 State Hwy O.
Marthasville, MO 63357
636-433-5410**



WARNING!

This product has NO WARRANTY unless:

1. It has been purchased from an **Authorized or **ViP FASS Dealer**. If in doubt, check www.FASSRide.com.**

2. It is registered within thirty (30) days of purchase.

Other conditions may apply. Please see full warranty information.

***NOTE:* Warranty is **void** if product was purchased below FASS website advertised pricing.**

ATTENTION!

Before you begin installation

Register for your Warranty ONLINE at

<https://www.fassride.com/register-a-warranty/>

No online access, call our TECH Support at

1-866-769-3747

FOLLOW THESE STEPS TO ENSURE A SIMPLE, CORRECT INSTALLATION OF YOUR NEW TITANIUM FUEL SYSTEM

ATTENTION:

Be sure to identify the proper FASS System and fuel line configuration. For help, our product finder can be found at www.FASSride.com. Follow the instructions to see fuel line detail.

- 1** Pay close attention to ALL WARNINGS
- 2** Read all instructions before starting installation of this product.
- 3** Inventory the package components. Notify the place of purchase immediately of any parts missing or damaged.
- 4** The installation recommendations contained within are guidelines. Use good judgment and take into consideration your vehicle's accessories.
- 5** For best results in accuracy and efficiency (due to training, communication, and our relationship with our dealer network), we recommend a VIP FASS dealer for the installation. They are prepared to install the FASS fuel pumps with the most efficiency. If a situation or problem arises during the installation, the dealer is prepared to handle it. Diesel Performance Products, Inc. is not responsible for any installation mistakes.
- 6** If you have any questions or concerns that cannot be addressed with your dealer, email or call FASS.

**If any installation procedure is uncertain, contact FASS technical support.
Call customer service at 636-433-5410,
or send us an e-mail: techsupport@FASSride.com
with the following information:**

Your name, address and daytime phone number

Model (ND-TSP-F18-180F-140G)

(ND-TSP-F18-250F-220G) (ND-TSP-F18-290F-240G)

Serial number

Last 6 digits of vehicles' VIN

Date of purchase

Nature of Your Concern

Serial number



INSTALLATION MANUAL
ND-TSP-F18-180F-140G
ND-TSP-F18-250F-220G
ND-TSP-F18-290F-240G

(Installation Videos are available at www.fassride.com)

RECOMMENDED APPLICATION

ND-TSP-F18-180F-140G: Powerstroke (6.7L) 2017-2022 with stock - 700 horsepower

ND-TSP-F18-250F-220G: Powerstroke (6.7L) 2017-2022 with 700 - 900 horsepower

ND-TSP-F18-290F-240G: Powerstroke (6.7L) 2017-2022 with 900 - 1,200 horsepower

- 1. Read all instructions before starting installation of this product!**
- 2. Installing the improper FASS Pump can cause severe engine damage.**
- 3. Secure vehicle from ROLLING!**
- 4. Cab and Chassis may require modifications**
- 5. Consult vehicle's manufacturers' instructions concerning the electrical system before attempting any electrical connections.**
- 6. Flush and clean all brass fittings and fuel line from debris.**
- 7. Keep debris from entering the internals of the system during installation. Getting debris in the water separator nipple can lock up the motor. If the motor does lock up from debris call FASS for technical assistance.**

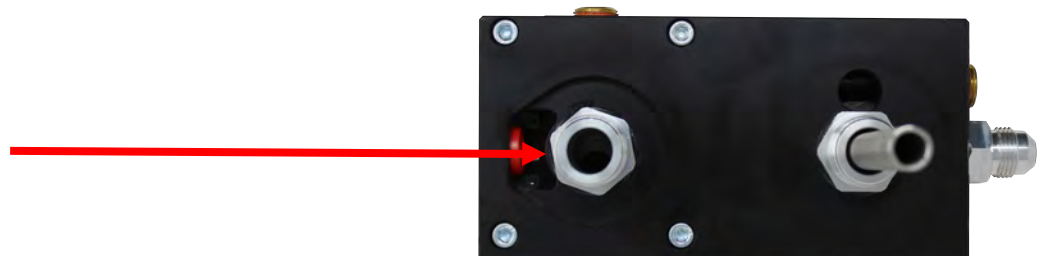

- 9. Wear safety glasses when operating power tools such as drills and grinders or when using a punch or chisel.**
- 10. Properly secure lines to prevent chaffing.**



WARNING!

Always be sure to fill the fuel tank to full after a new FASS installation. Failure to do so can result in excessive sound output, or priming issues!

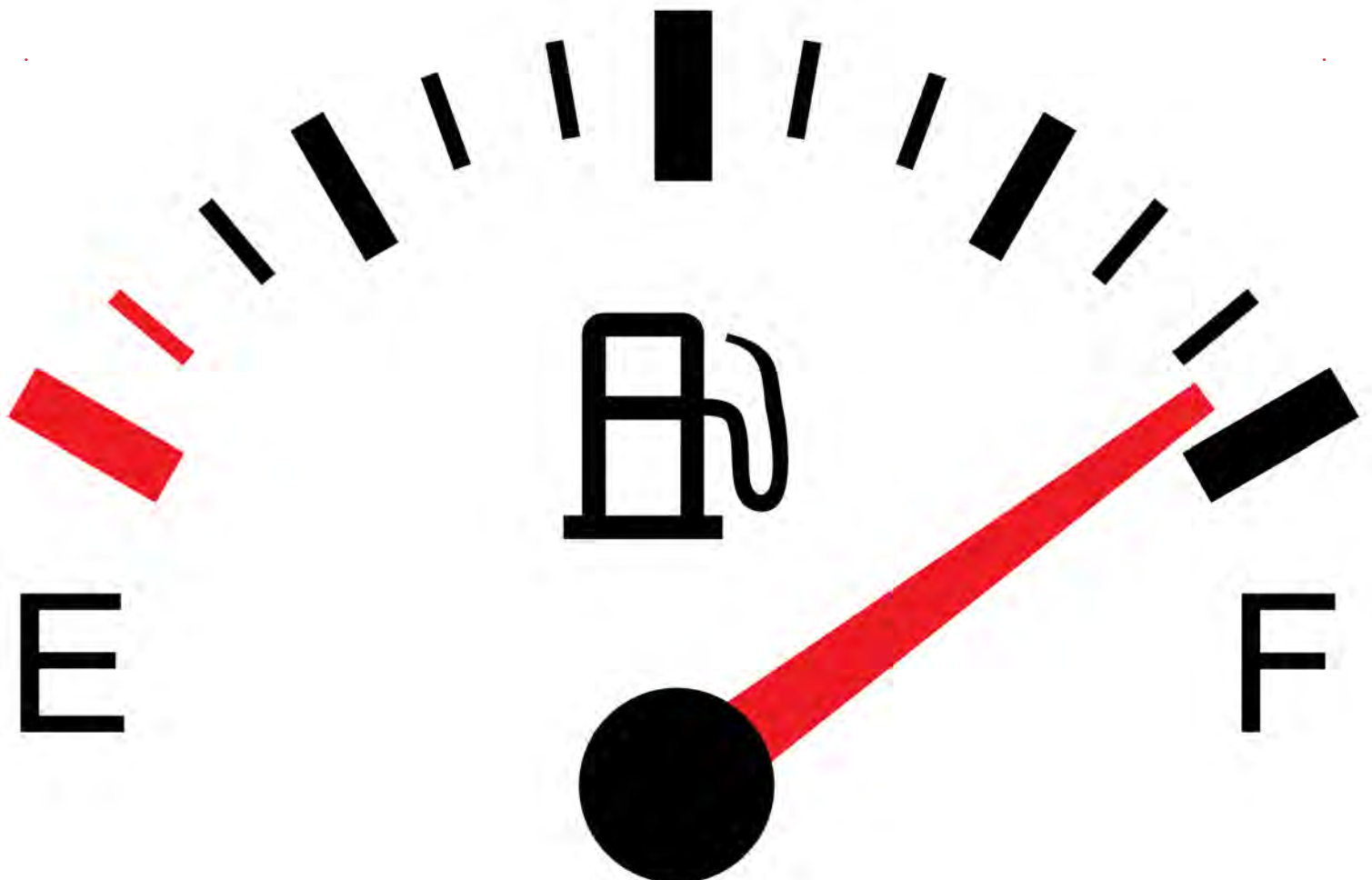

SIGNATURE SERIES PLUS

140 GPH OR 220 GPH OR 240 GPH

65 psi (Approximately)

Rear View



Front View

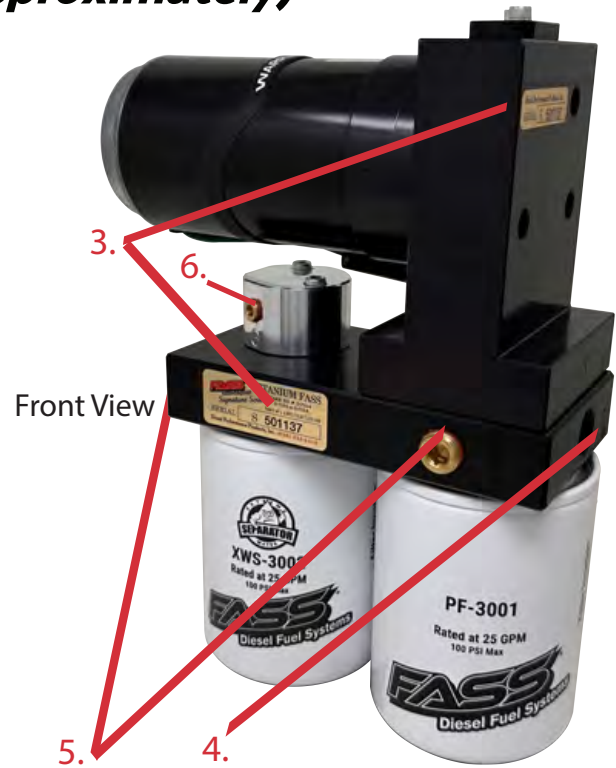

PUMP GUIDE:

- 1. "E" To Engine**
- 2. "R" Return to Tank**
- 3. Serial Number**
- 4. "T" Fuel Inlet**
- 5. Electric Heater Ports**
- 6. "G" Gauge Port**

INSTALLATION

GUIDE:

- Step 1. Install Electrical Harness**
- Step 2. Prep the FASS**
- Step 3. Mount the FASS**
- Step 4. Fuel Line Supply**
- Step 5. Review Installation**



TITANIUM

www.fassride.com

(866) 769.3747

SIGNATURE SERIES PLUS

140 GPH OR 220 GPH OR 240 GPH

65 PSI (Approximately)

Note: Going over 100 PSI WILL void warranty.

**NOTE: WARRANTY MAY BE VOID
IF SILICONE BAND IS REMOVED
FROM MOTOR!!**



CONTENTS

NOTE: Owner's Manual available for download on our website,
www.FASSride.com



PBR-2004



PBR-2001



MP-TSP-9077-ND



LRB-1001



FL-1002-BK x17'



FL-1058-BK x7'



WH-1006-3



LR-1001



SP-5501



SC-5501

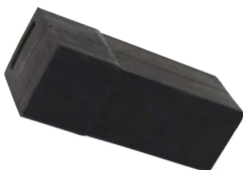

RELAY COVER



30 AMP FUSE

MOUNTING PACKAGE CONTENTS



AN-8-ORB-10-BK



AN-10-ORB-10-BK



PL-2058-BK



**TWO (2)
PL-2003-BK**



QC-PLUG-12



**TWO (2)
QC-4600**



**THREE (3)
WA-1001D**



SHCS 3/8"-16x2"



PL-10-ORB-10-BK



10-305



46116

**ADD-A-CIRCUIT
46177**



PL-8-ORB-10-BK



**ONE (1)
HC-1001**



**TWO (2)
72478**



**FOUR(4) HEX BOLT
3/8"-16x11/2"**



**THREE(3)
HEX
BOLT
1/4"-20x
13/4"**

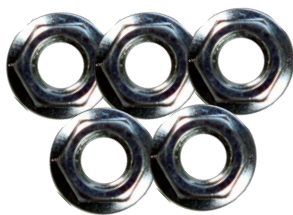

**FIVE (5)
LOCKING NUT 3/8"**



**FIVE (5)
3/8" WASHERS**



**TWO (2)
RING TERMINAL**



A614C56-55-05

MOUNTING PACKAGE CONTENTS

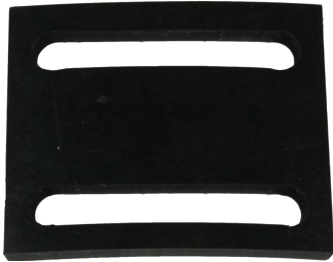

RS-2002



**TWO (2)
SELF TAPPING SCREW**

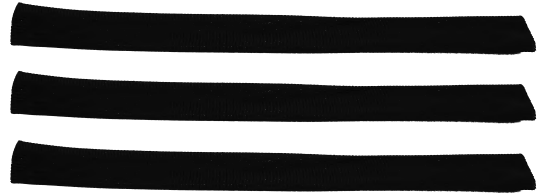

**THREE (3)
1,200°F HEAT SHIELD**



CABLE TIES



DIELECTRIC GREASE



**TWO (2)
OR-017**

OR-030

NOTE: THESE SPARE BASE O-RINGS ARE INCLUDED WITH THE KIT IN THE EVENT OF A PINCHED O-RING DURING ASSEMBLY



LOCKING NUT 5/16"



5/16" WASHERS



**HEX BOLT
3/8" -16x1"**



**HEX BOLT
5/16" -18x1"**

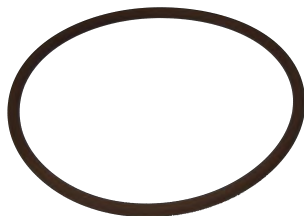

OR-350VITON



O424860

STEP 1: **INSTALLING ELECTRICAL HARNESS**

- A.** Using the supplied dielectric grease, apply a small amount to the relay pig tail and the fuse holder.



STEP 1: **INSTALLING ELECTRICAL HARNESS**

B. Once applied, install the supplied relay into the relay pig tail and the 30 amp fuse into the fuse holder.



STEP 1: **INSTALLING ELECTRICAL HARNESS**

- C. With the relay and 30 amp fuse installed, install the relay cover and fuse holder cover.



STEP 1:

INSTALLING ELECTRICAL HARNESS

D. Crimp the supplied ring terminals to the red and green wires of the WH-1006-3. Attach the red wire to the positive terminal of the battery and the green wire to the negative terminal of the battery.

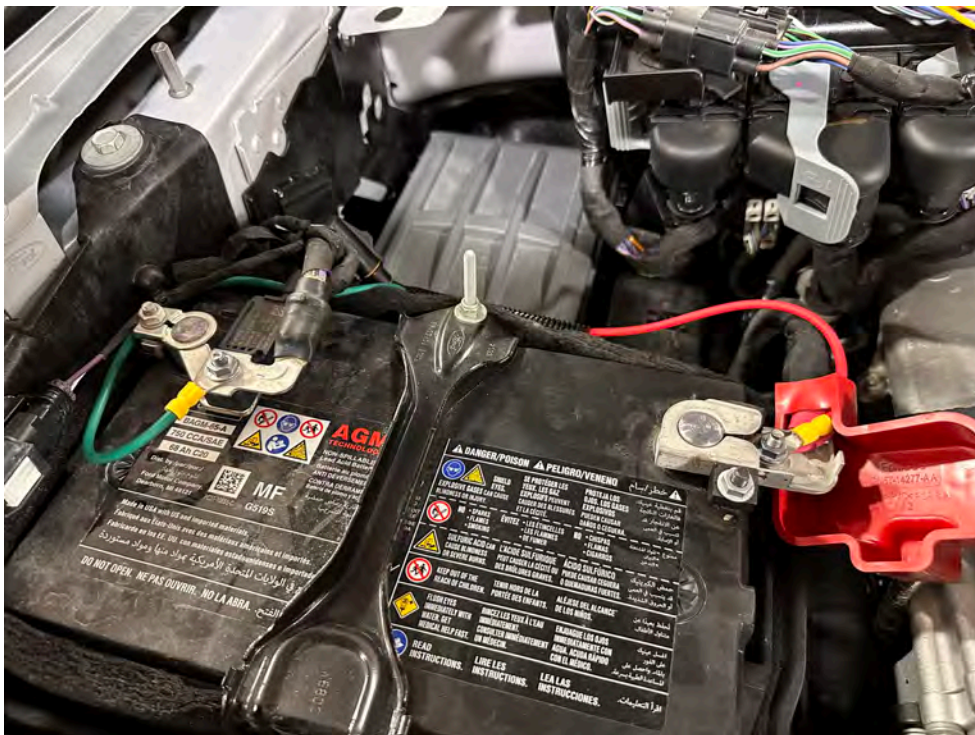
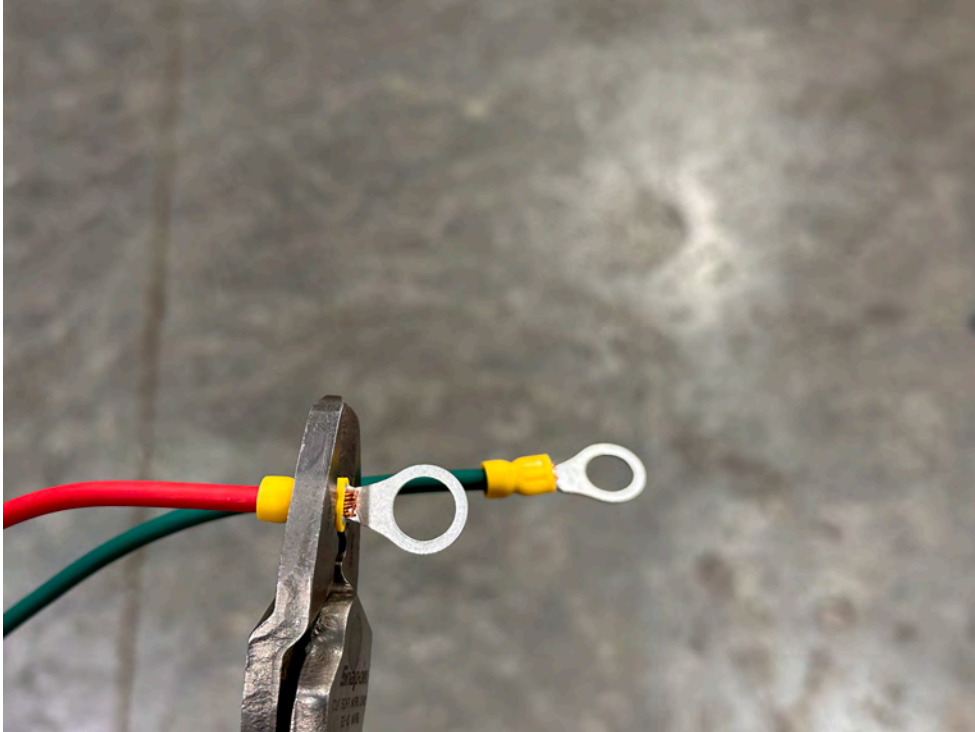

STEP 1: **INSTALLING ELECTRICAL HARNESS**

E. Secure the relay and fuse holder in an upright position, as shown , to prevent moisture from entering.

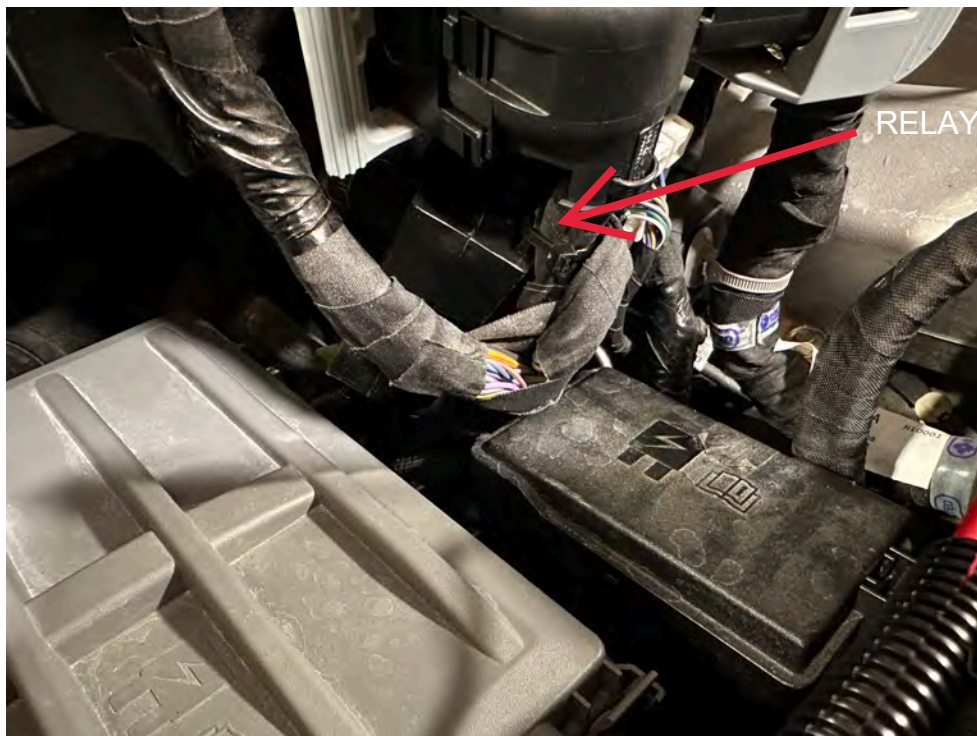
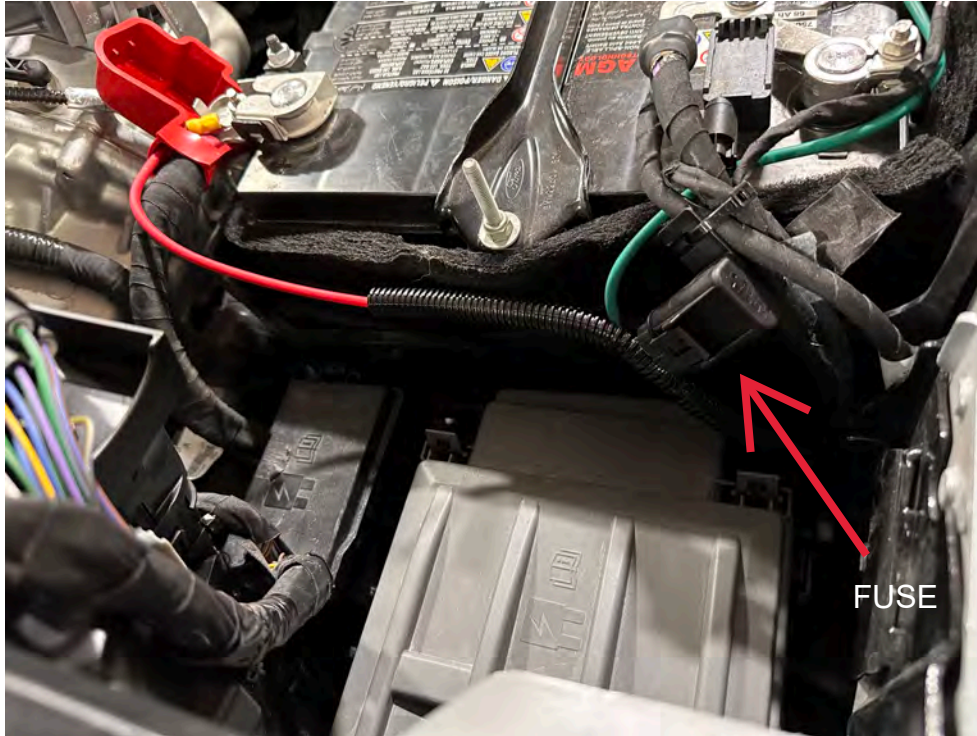

STEP 1: **INSTALL ELECTRICAL HARNESS**

F. Using wire stripping tool, remove excess insulation off the add-a-fuse and the WH-1006-3



STEP 1: **INSTALL ELECTRICAL HARNESS**

G. Place wire from ADD-A-CIRCUIT 46177 and WH-1006-3 into butt connector. Using crimping tool connect ADD-A-CIRCUIT 46177 and WH-1006-3 with butt connector. Install 46116 to ADD-A-CIRCUIT 46117 top slot (near wire that feeds additional circuit).

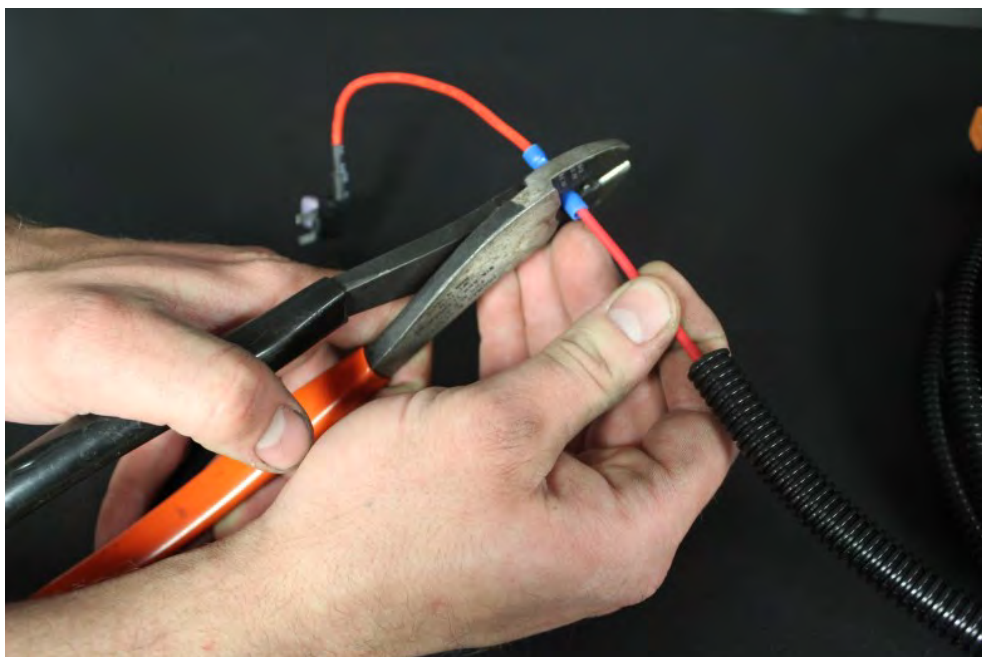
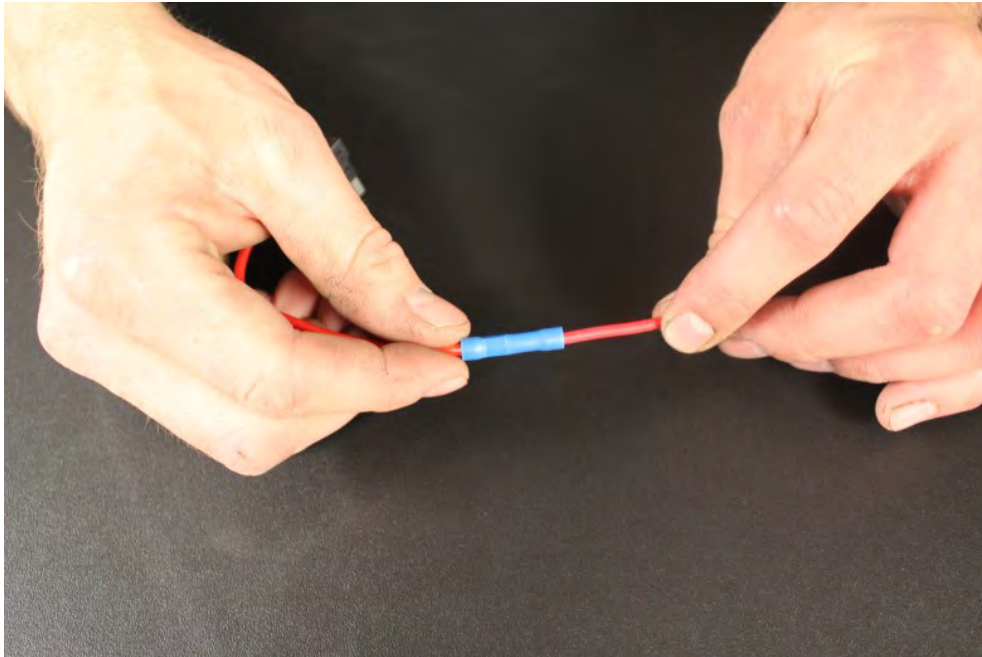

STEP 1: **INSTALL ELECTRICAL HARNESS**

H. Route the single red wire of WH-1006-3 to the engine bay fuse panel. Remove a fuse (maximum of 10A) that is “hot” when the key is on. Use a test probe to locate the “hot side” of the circuit in the fuse block. Install the Add-A-Circuit into the open location. Install the pulled fuse into the open space on the fuse tap.

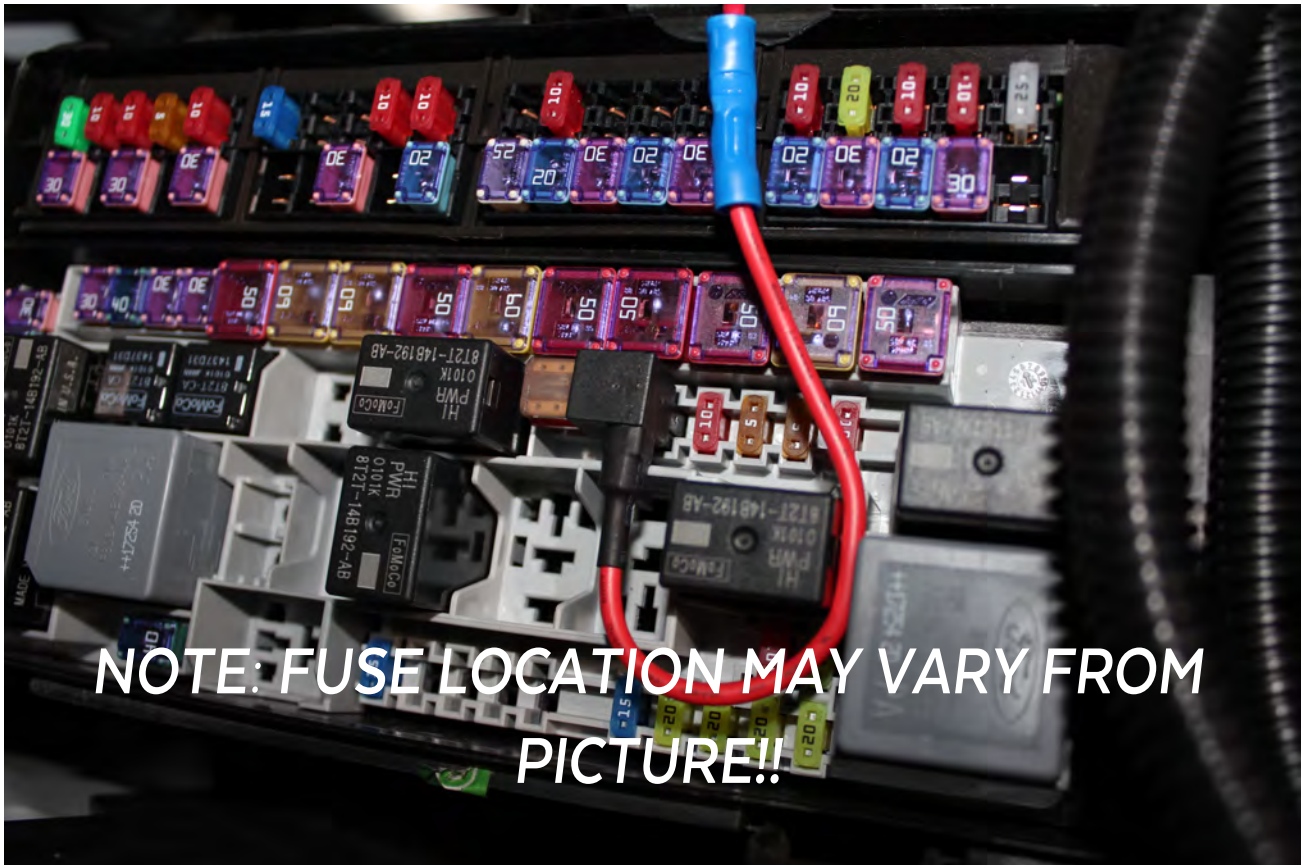

**NOTE: FUSE LOCATION MAY VARY FROM
PICTURE!!**



www.fassride.com

(866) 769.3747

STEP 1:

INSTALLING ELECTRICAL HARNESS

I. Route WH-1006-3 wire harness along frame rail to mounting location of pump. Completion of this step will be addressed in the mounting step.

NOTE:

ATTENTION: While installing fittings into Titanium pump
DO NOT Apply side pressure to draw tube of pump

PROPER



IMPROPER

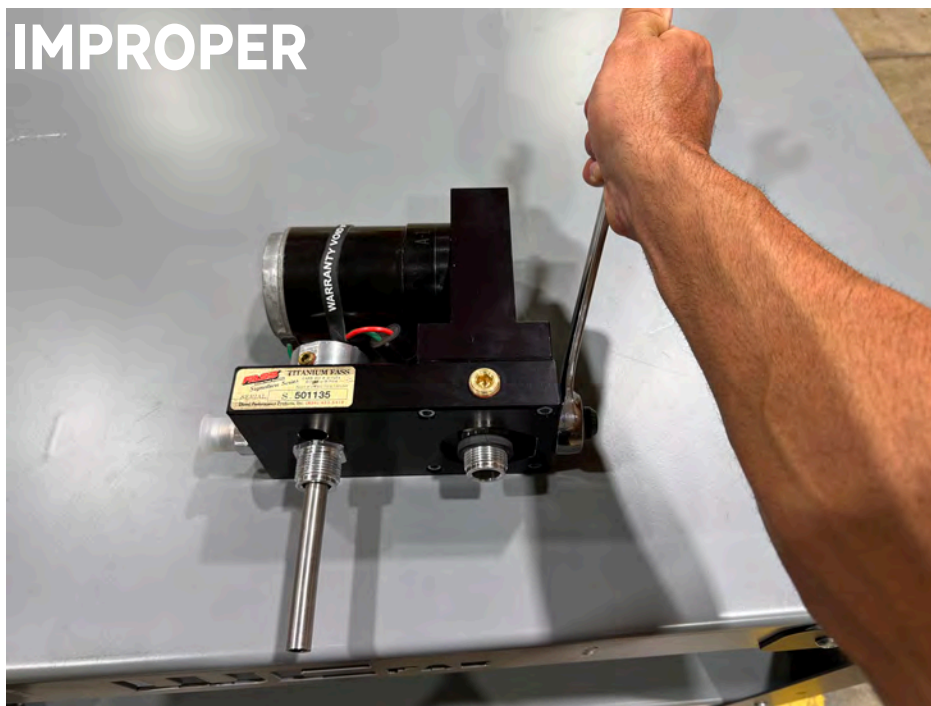

STEP 2: **MOUNT FUEL SYSTEM**

A. Place the 3/8" and 5/16" bolts through the supplied washers and the factory drilled holes on the rear passenger body mount. Place PBR-2004 onto the factory body mount using the supplied locking nuts and tighten accordingly.



STEP 2: **MOUNT FUEL SYSTEM**

NOTE: Before installing fittings make sure to inspect for burs or flare imperfections. When cutting fuel line make sure to blow out line to keep debris from moving forward.

B. Install AN-8-ORB-10-BK into the E port of the FASS and AN-10-ORB-10-BK into the T port of the FASS. Tighten both fittings accordingly.



STEP 2: **MOUNT FUEL SYSTEM**

C. Place the three supplied aluminum spacers onto the FASS as pictured. Place the three 1/4" bolts through PBR-2001 and place the bracket onto the FASS and tighten accordingly.

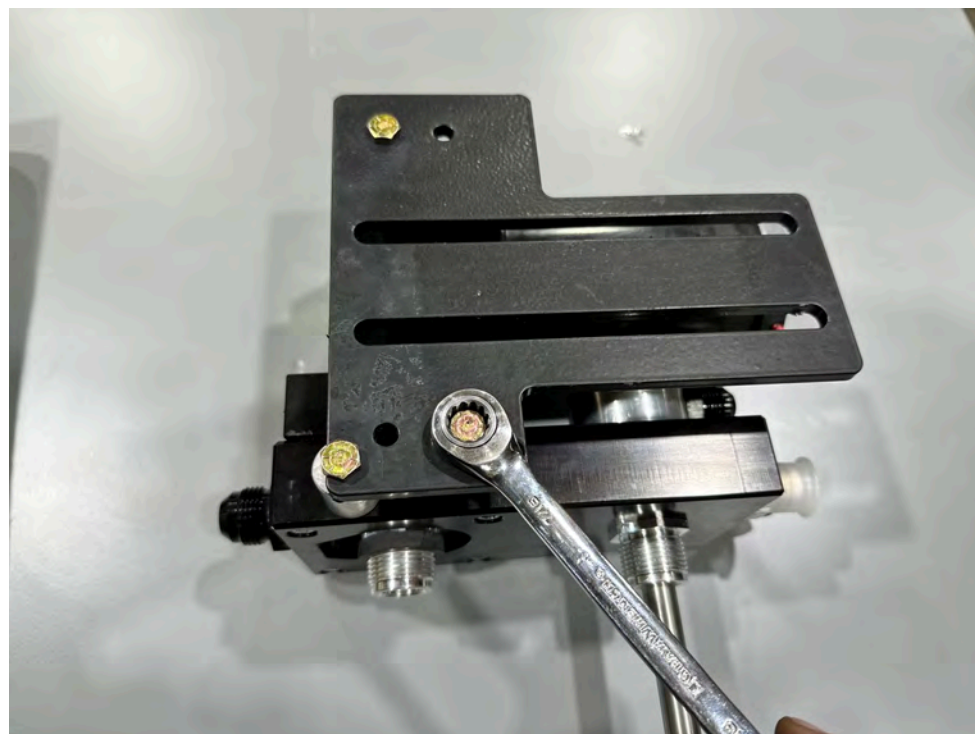

STEP 2: **MOUNT FUEL SYSTEM**

D. Place the four 3/8" bolts through the supplied washers and PBR-2001 with the supplied rubber spacer RS-2002. Place the bracket onto PBR-2004 using the four supplied locking nuts and tighten accordingly.

NOTE: TORQUE BOLTS NOT FLANGE NUTS



STEP 2: **MOUNT FUEL SYSTEM**

NOTE: If fuel pressure gauge is pulsating after FASS installation, use snubber valve (Cat Part # 7S-3795)

E. Apply grease to the gasket located on the filters. Attach to the system and hand tighten.



Extreme Water Separator - Install XWS-3002 on side of pump with draw tube in the middle of the filter nipple.



Particulate Filter - Install PF-3001 on filter nipple without the draw tube. Make sure to insert O-Ring provided on nipple.



Note: O-Ring must be put back on the suction side of pump. Failure to do so can result in priming issues, cavitation or pressure losses.

STEP 3: **SUMP INSTALLATION**

A. Remove the OEM fuel tank skid plate.

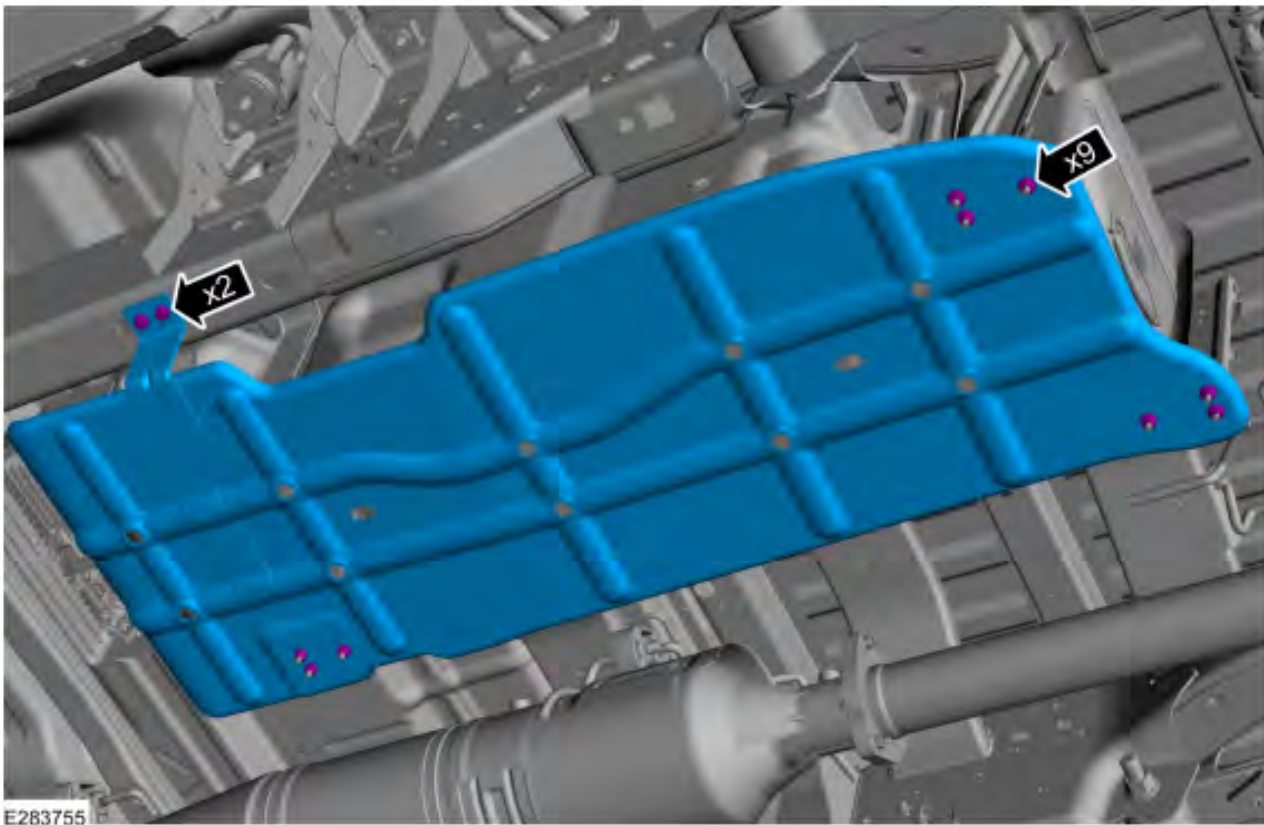

STEP 3: **SUMP INSTALLATION**

B. Locate the lowest point of the fuel tank, which is typically below the factory fuel module. On some applications there is a dimple you can use for a center point reference and it has the flattest surface for sealing the sump.



STEP 3: **SUMP INSTALLATION**

C. Using the center point, drill a small hole to drain the remaining fuel. Recommend having a container large enough to retain the remain fuel. Allow fuel to drain completely.



STEP 3: **SUMP INSTALLATION**

- D. Using a 3-3/4" hole saw drill the center point previously marked or notated.



STEP 3: **SUMP INSTALLATION**

E. Deburr hole and remove all shavings.



STEP 3: **SUMP INSTALLATION**

F. Install SC-5501 into fuel tank positioned as shown.

NOTE: THIS SIDE FACES SP-5501

NOTE: THIS SIDE FACES THE INSIDE OF TANK



STEP 3: **SUMP INSTALLATION**

- G.** Using grease, install OR-350VITON into the groove of SP-5501.



STEP 3: **SUMP INSTALLATION**

H. Install the supplied 3/8-16x2" SHCS through 0424860 and hand tighten SP-5501 into place.



**NOTE: 0424860 MUST BE INSTALLED BEFORE
TIGHTENING SP-5501 INTO PLACE**



STEP 3: **SUMP INSTALLATION**

I. Rotate SP-5501 to your desired position and torque the 3/8-16x2" SHCS to 12 FT/LBS .

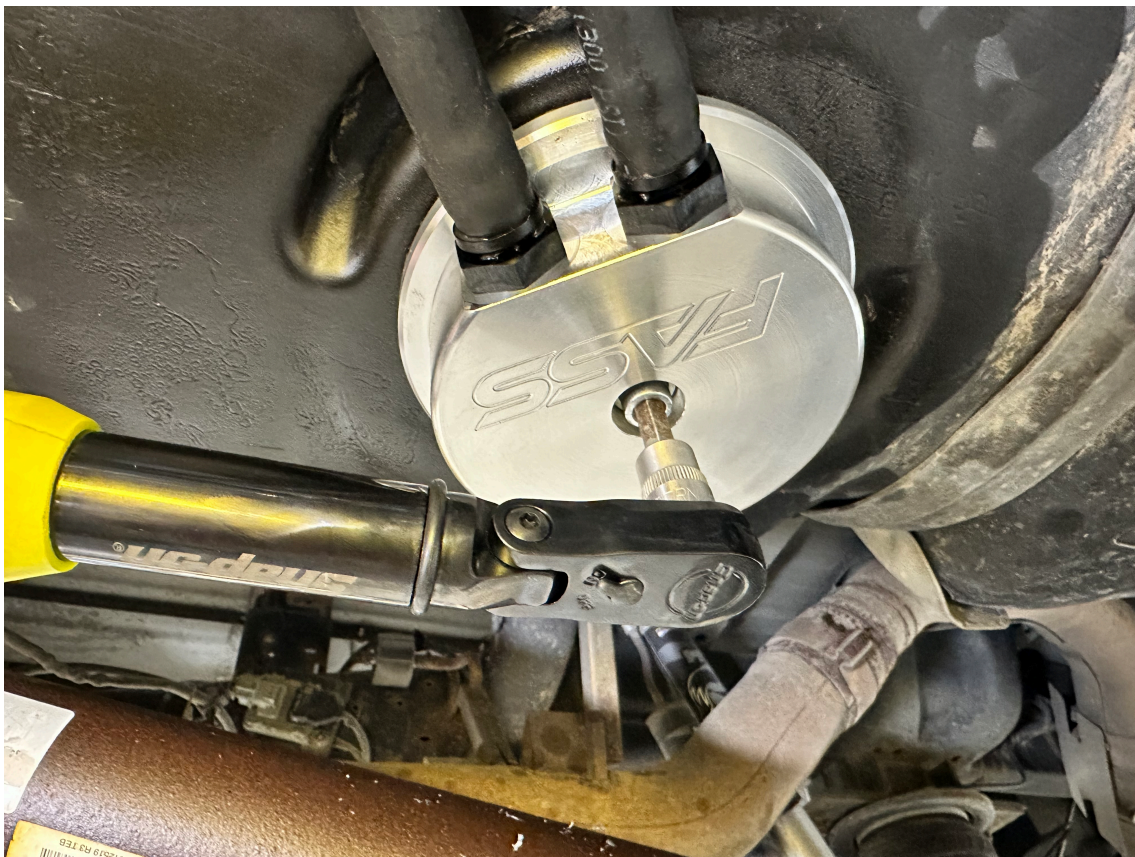

STEP 3: **SUMP INSTALLATION**

NOTE: YOU WILL NEED TO USE A HOLESAW OR SIMILAR TOOL AND CUT A CLEARANCE HOLE IN THE SKID PLATE FOR THE SUMP.

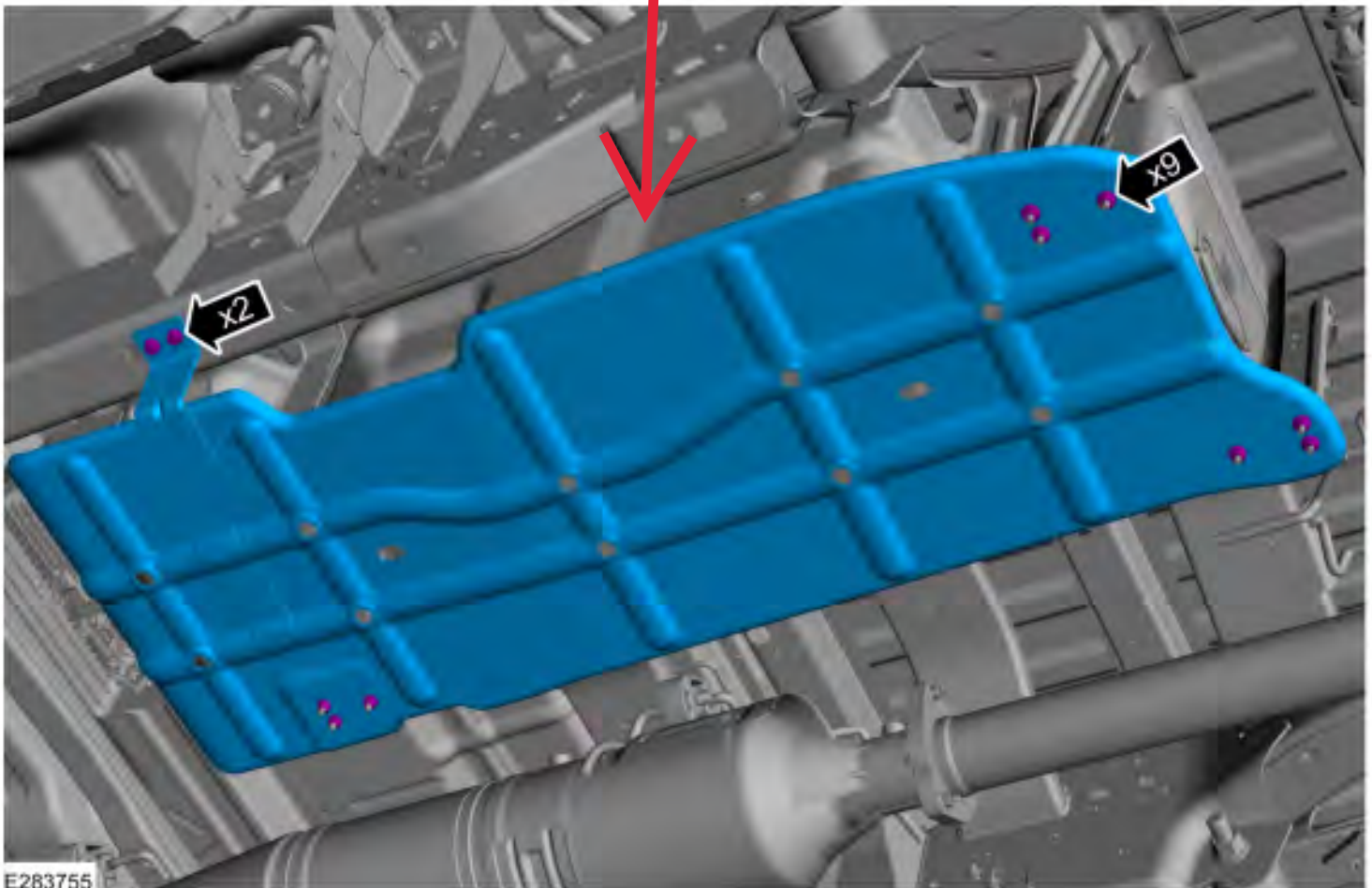

NOTE: RETURN PORT AND POCKET

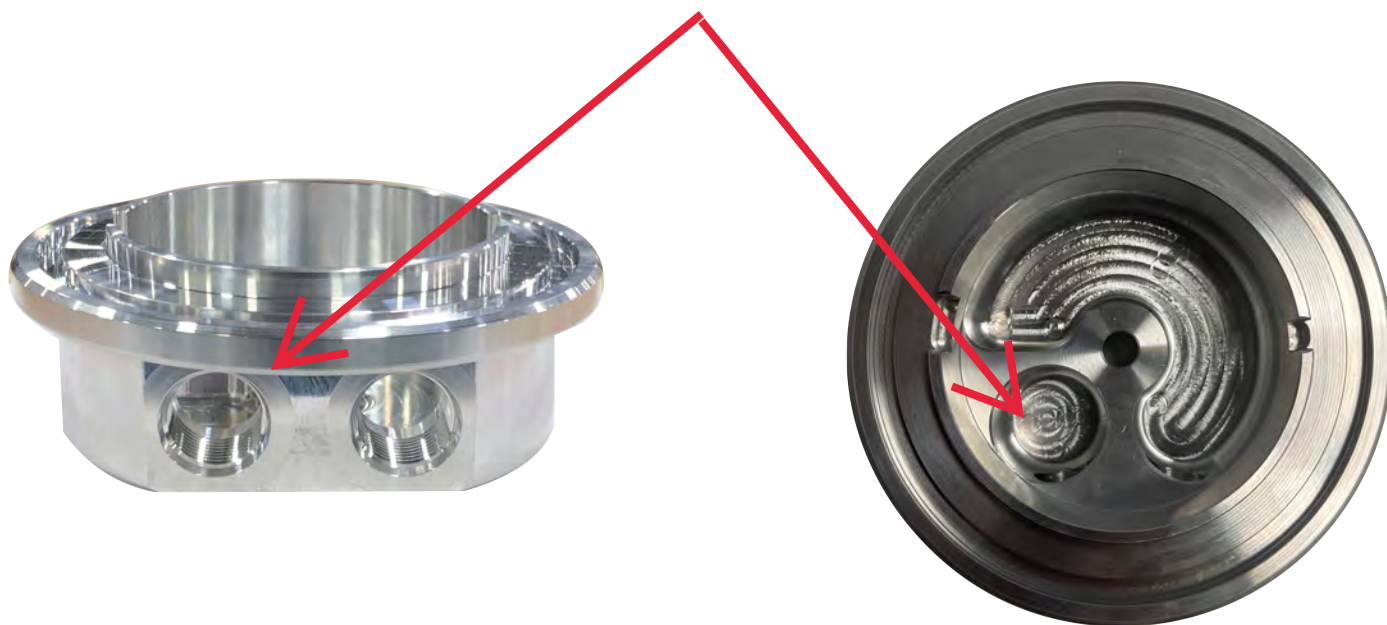

NOTE: SUPPLY PORT AND POCKET

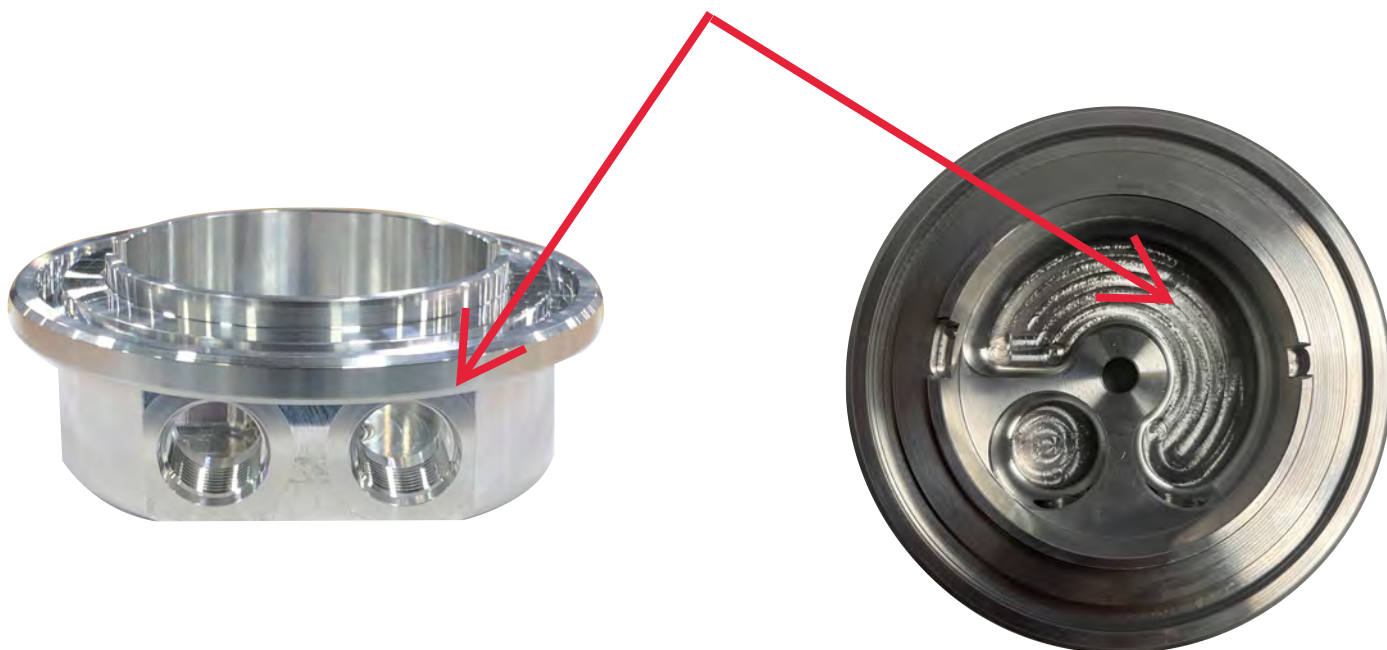

STEP 3: **SUMP INSTALLATION**

- J. Install PL-8-ORB-10-BK into the return port of SP-5501 and tighten accordingly.



STEP 3:
SUMP INSTALLATION

K. Install PL-10-ORB-10-BK into the suction port of SP-5501 and tighten accordingly.



STEP 4: **INSTALL FUEL LINES**

- A.** Using thread tape, install QC-4600 into both sides of 10-305 and tighten accordingly.



STEP 4: **INSTALL FUEL LINES**

B. Disconnect the OEM fuel lines and install the previously assembled quick connect fitting to bypass the fuel conditioning module as pictured.



TO SENDING UNIT

**FUEL RETURN
LINE FROM THE
ENGINE**

WARNING:

The supplied 1,200°F heat shielding must be installed where FASS fuel line routes above the exhaust system. Failure to install heat shielding can result in a possible fire hazard!

NOTE: Install heat shielding where fuel lines route above the exhaust system!



STEP 4: **INSTALL FUEL LINE**

C. Using grease, press the fuel return line to the return port fitting of SP-5501. Route the fuel line to the "R" port on the FASS, then install PL-2003-BK into FL-1002-BK using grease. Install PL-2003-BK onto the FASS return fitting and tighten accordingly.

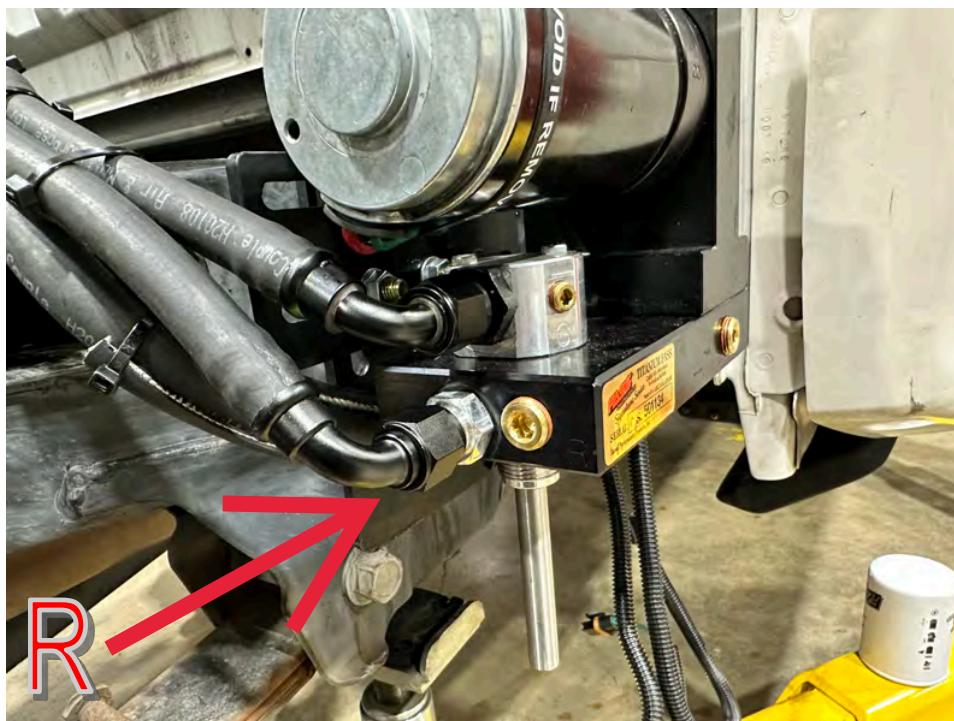

STEP 4: **INSTALL FUEL LINE**

D. Using grease, press the suction line onto the PL-10-ORB-10-BK in the suction port of the sump. Route FL-1058-BK to the "T" port of the FASS and trim to length. Press PL-2058-BK into FL-1058-BK. Using grease, install onto AN-10-ORB-10-BK and tighten accordingly.



STEP 4:
INSTALL FUEL LINE

Caution: DO NOT use sealant on AN fittings

E. Insert PL-1005-BK into the remaining fuel line. Connect to the 'E' port of the FASS system. Use oil. Torque to 18 ft./lbs. Route this line up to the OEM engine feed line.

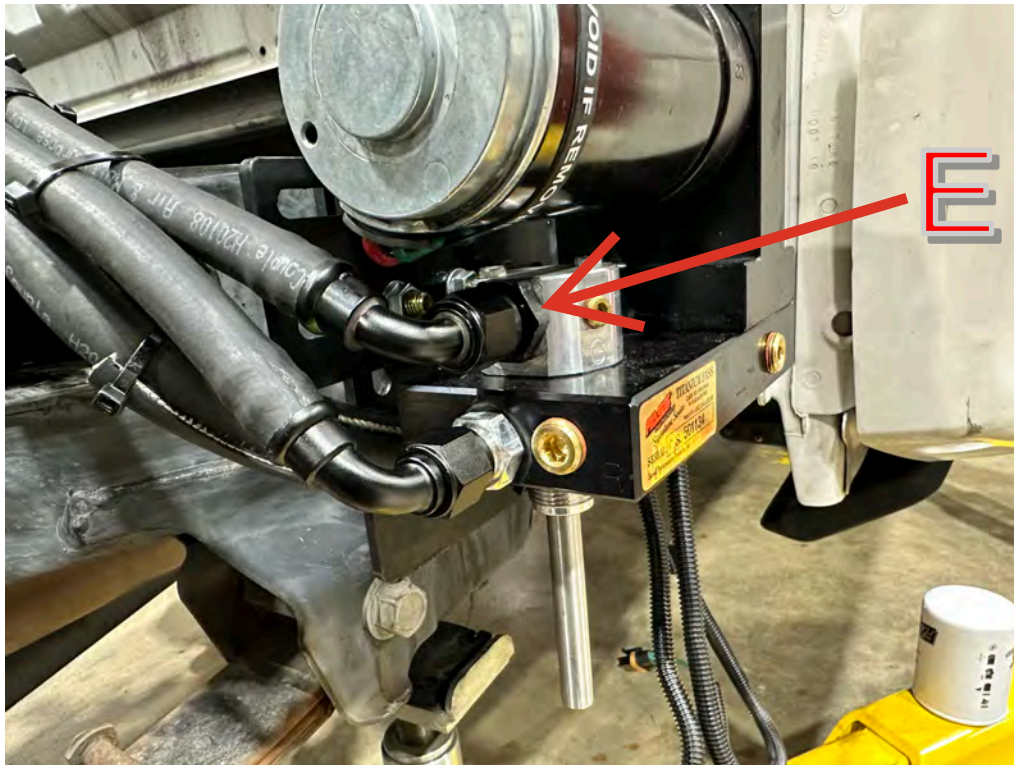

STEP 4:
INSTALL FUEL LINE

Caution: DO NOT use sealant on AN fittings

F. Install QC-PLUG-12 into the open quick connect fitting.



STEP 4:
INSTALL FUEL LINE

Caution: DO NOT use sealant on AN fittings

E. Install A614C56-55-05 into FL-1002-BK and secure with hose clamp HC-1001. Connect A614C56-55-05 to the engine feed line.

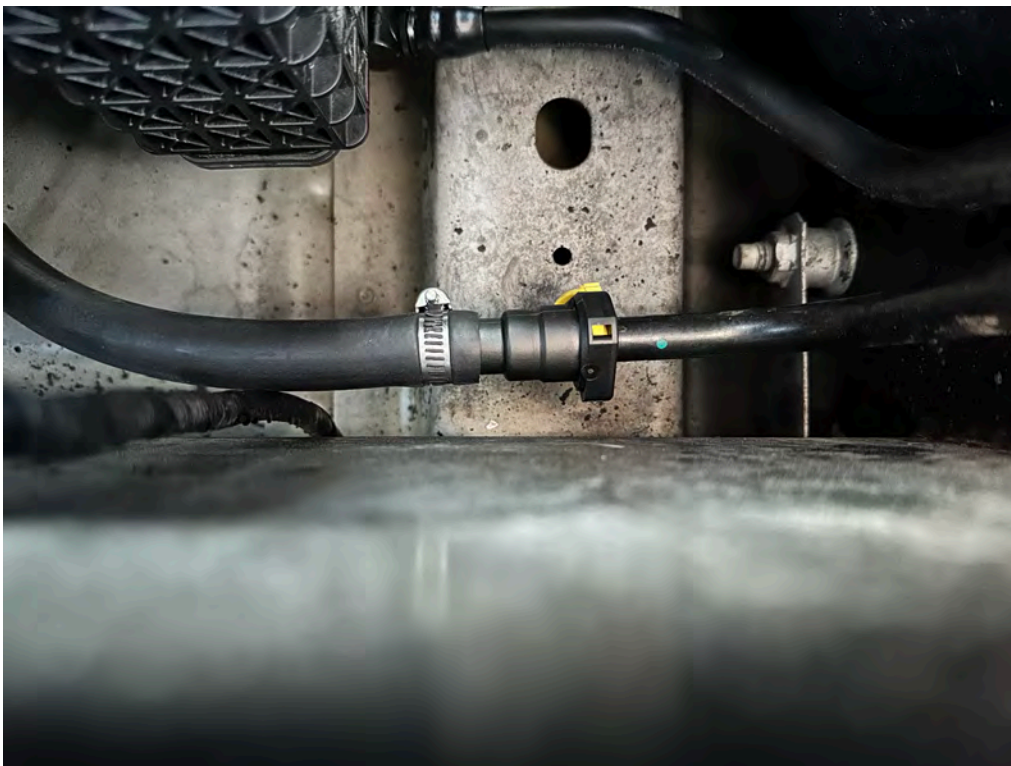

STEP 4: **INSTALL FUEL LINE**

H. Secure all fuel lines and electrical components away from any moving parts using supplied cable ties.

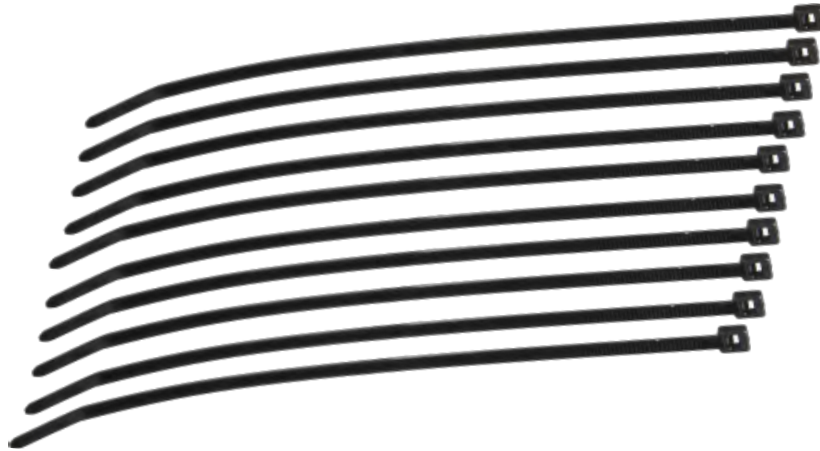

STEP 4: **INSTALL FUEL LINE**

I. We recommend putting approximately 5 gallons of fuel in the tank prior to filling the tank to check for fuel leaks. Prime the FASS system and check for leaks. Once you confirm no fuel leaks, the tank can be filled to capacity.



STEP 5: **REVIEW INSTALLATION**

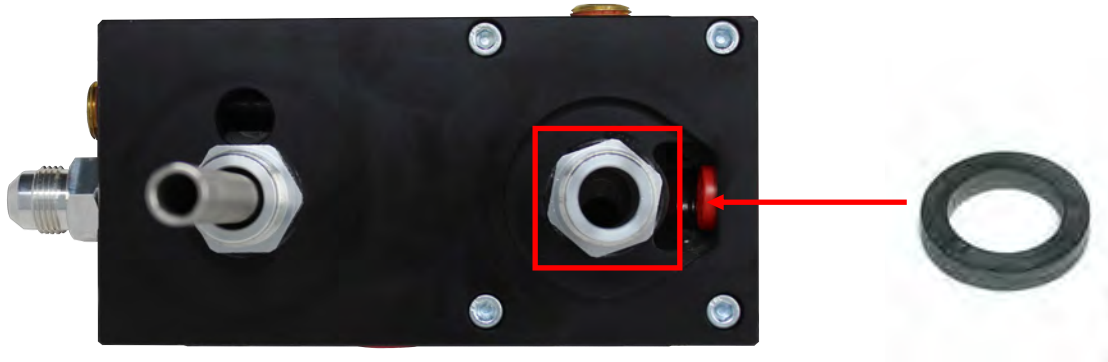

Note: O-Ring must be put back on suction side of pump. Failure to do so can result in priming issues, cavitation, or pressure losses.

1. **Blow out any open lines/cover any open ports**
2. **Bolts and fasteners properly tightened?**
3. **Electrical harness and fuel lines secured and properly tightened? Reconnect the battery.**
4. **Has the system been primed?**
 - a. **Turn key to the ignition position, turning on the FASS pump for 15 sec..**
 - b. **Crank engine and allow to run for at least 1 minute.**
5. **Check for leaks.**
6. **Start the engine**
7. **Recheck all fluid and filter connections for leaks**
8. **This pump comes with a 1 Year Manufacturer's Warranty based on the date it has been manufactured. To receive your extended Lifetime Warranty, you have 30 days from date of purchase to send the completed warranty information**



www.fassride.com

(866) 769.3747

LIMITATION OF LIFETIME WARRANTY

Disclaimer: To help insure you receive the proper system and customer support at the local level, FASS has a VIP and Authorized Dealer network representing FASS products. This is one reason you must purchase through a dealer to comply with our warranty policies. If you do not, there is no warranty! We recommend you go to www.FASSride.com, click "Find a Dealer", put in their ZIP code, select the type of dealer, and see if the company you purchased from is listed. If they are not, put their phone number in the field below the ZIP code field to see if they are listed. Below these two fields is a list of "Terminated/Unauthorized" dealers. You may want to review this list. If the company is not listed or is on the "Terminated/Unauthorized" list, we suggest you return the product immediately to that dealer and call FASS. We'll recommend you to the nearest dealer.

Diesel Performance Products, Inc. (hereafter "SELLER") gives Limited Warranty as to description, quality, merchantability, fitness for any product's purpose, productiveness, or any other matter of SELLER'S product sold herewith. The SELLER shall be in no way responsible for the product's open use and service and the BUYER hereby waives all rights other than those expressly written herein. This Warranty shall not be extended or varied except by a written instrument signed by SELLER and BUYER.

When MANUFACTURER receives the "ORIGINAL" PRODUCT REGISTRATION form with a copy of the "BILL OF SALE/SALES RECEIPT" within 30 days of the sale, then the following applies! The Warranty will then and only then be validated to that of which typically accompanies your unit for your specific application from the date of sale or for recommended service life and limited solely to the original purchaser and/or vehicle and parts contained within the product's kit. This warranty does not cover normal wear on consumable items such as but not limited to filters, fuel line, wire harness & etc. The warranty does not cover seized gears due to lack of filtration. Warranty is voided if used with other than diesel fuel. Returned items will arrive prepaid to the place of purchase. Diesel Performance Products, Inc. will repair, without cost, any product found to be defective during the warranty period; parts only, or at its option, will replace such products in exchange for the product. Repair or replacements are warranted for the remainder of the original warranty period. All Warranty claims are subject to approval by Diesel Performance Products, Inc.

A Return Material Authorization (RMA) number must be obtained before any product is to be returned to Diesel Performance Products, Inc. for warranty consideration, repair or product return. Requests for product returns must be offset by an equal value order. Return parts must be completed and in resalable condition. No returns after 30 days.

The following information is required to obtain a RMA number before returning product:

Your Name, Address, and Phone Number's

Model and Serial Number (Not Motor Number) Example: Model HD Series, Serial: 00125966 VIN Number of Vehicle

Date of Purchase

Nature of Problem

RMA and Product Serial Number must be on all paperwork and correspondence. Failure to obtain the required information or paperwork will result in \$25.00/item penalty and delay or denial of any warranty claim.

Under no circumstances shall the SELLER and/or MANUFACTURER be liable for any labor charged or travel time incurred in diagnosis for defects, removal, or reinstallation of this product, or any other contingent expenses.

Under no circumstances shall the SELLER and/or MANUFACTURER be liable for any damage or expenses insured by reason of the use or sale of any such equipment. This warranty does not apply to products which Diesel Performance Products, Inc. has determined to have been misused or abused, improperly maintained by the user, or where the malfunction or defect can be attributed to the use of non-genuine Diesel Performance Products, Inc. parts.

IN THE EVENT THAT THE BUYER DOES NOT AGREE WITH THIS AGREEMENT: THE BUYER MAY PROMPTLY RETURN THIS PRODUCT, IN A NEW AND UNUSED CONDITION, WITH A DATED PROOF OF PURCHASE, TO THE PLACE OF PURCHASE WITHIN THIRTY (30) DAYS FROM DATE OF PURCHASE FOR A FULL REFUND LESS SHIPPING.

THE INSTALLATION OF THIS PRODUCT INDICATES THAT THE BUYER HAS READ AND UNDERSTANDS THIS AGREEMENT AND ACCEPTS ITS TERMS AND CONDITIONS.