



# User Manual



# TABLE OF CONTENTS

|                |  |
|----------------|--|
| <b>PAGE 3</b>  | <b>Safety Warnings</b>                     |
| <b>PAGE 4</b>  | <b>Features &amp; Included Accessories</b> |
| <b>PAGE 5</b>  | <b>Display Screen</b>                      |
| <b>PAGE 6</b>  | <b>Battery Installation</b>                |
| <b>PAGE 7</b>  | <b>Charger</b>                             |
| <b>PAGE 9</b>  | <b>Remote Control</b>                      |
| <b>PAGE 10</b> | <b>Operation</b>                           |
| <b>PAGE 13</b> | <b>Troubleshooting</b>                     |
| <b>PAGE 14</b> | <b>Specifications</b>                      |
| <b>PAGE 15</b> | <b>Additional Accessories</b>              |
| <b>PAGE 16</b> | <b>Limited Warranty</b>                    |

# SAFETY WARNINGS



READ INSTRUCTIONS

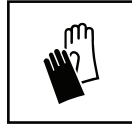

ALWAYS WEAR GLOVES



ALWAYS USE WINCH STRAP



PINCH HAZARD  
KEEP FINGERS AWAY



DO NOT USE WINCH TO  
TRANSPORT PEOPLE

- Take time to fully read the manual in order to understand your tool and its operation.
- Always wear gloves, eye and ear protection, and suitable clothes, cover any long hair.
- Always fully inspect the tool and accessories before use.
- Always tightly wind rope onto drum before or during use.
- Never touch rope or hook under load.
- Always check the status of the battery before use.
- Always wear gloves when handling rope to avoid injury.
- Always use hook strap (included) whenever pulling rope, during installation and during operation.
- Always switch the power off when not in use or performing maintenance.
- Always stand clear of rope and load and keep others away while pulling / lifting.
- Always remove any element or obstacle that may interfere with safe operation of the winch.
- Always check rope wear and the stability of load.
- Always inspect rope, hook and slings before operating winch. Damaged components must be replaced immediately. Always keep rope in tension during operation, tightly wound rope reduces the chance of binding and protects rope and winches from damage.
- Never pull out rope over the red warning mark.
- Always stand clear of winch rope and load while winding.
- Ask others to keep away from scenes
- Never operate this machine when under the influence of drugs, alcohol or medication.
- Never operate this winch when you feel tired, sleepiness or other physical discomfort.
- Never operate this winch if you are under 16 years of age.
- Always dispose or recycle battery according to local ordinances / regulations.
- Never charge battery in damp or wet environment. Always disconnect charger when battery is fully charged. Never probe with conductive object.
- Always fully charge battery before use.
- Never completely discharge battery.
- Always charge battery every six months if not in use.
- Never operate the portable winch during charging.
- Never leave the tool near heat sources.
- Always use the provided charger and battery.
- Never operate the portable winch if there are any violent impact or damage.
- Never use in the rain or wet environment to protect motor from water and mud.
- Never burn batteries.
- Never short battery terminals, it may cause sparks or burns.
- Never attach a recovery strap to the portable winch hook to increase the length of a pull,
- Always use a hook with a latch.
- Always ensure hook latch is closed and not supporting load.
- Never apply load to hook tip or latch. Apply load only to the center of hook.
- Never use a hook whose throat opening has increased, or whose tip is bent or twisted.
- Never attempt to tow a vehicle or object with the recovery strap attached directly to the portable winch hook.
- Never use bungee straps that develop tremendous and potentially dangerous amounts of force when stretched.
- Always avoid side pulls which can pile up rope at one end of the drum. This can damage rope or portable winch.
- Never hook rope back onto itself. This will damage the rope.
- Always use a choker chain, choker rope, or strap.
- Never use portable winch to lift or move people.
- Never use portable winch to lift load over people.
- Always use suitable anchor point when handling load. Never use portable winch to secure a load.
- Never shock load rope. Shock load can damage, overload and break rope.
- Never use the portable winch's rope to tow another load.
- Vehicle or object collision during towing can exceed rope strength.
- Always make sure the anchor you select will withstand the load and the strap or chain will not slip.
- Always take time to use appropriate rigging techniques for pulling / lifting.
- Never spool out past length of red rope.
- Never exceed portable winch or rope capacity listed on product data sheet. Using a snatch block to reduce portable winch load. Never exceed 1000 lb. (454 kg) Maximum pulling capacity.
- Always use factory approved mounting hardware, components, and accessories.
- Always rewind under tension load after use.
- Tightly wound rope reduces chances of "binding", which can damage the rope.
- Always wind the rope onto the drum in the direction specified by the product warning label on the product and/or documentation. Always avoid turning switch on and off while using this product. This can damage motor controls unit and rope.

# FEATURES & INCLUDED ACCESSORIES

|   |                       |
|---|-----------------------|
| 1 | Variable Speed Switch |
| 2 | Direction Switch      |
| 3 | Power Switch          |
| 4 | Swiveling Anchor Hook |

|   |                           |
|---|---------------------------|
| 5 | Charging Dock/Remote port |
| 6 | Display Screen            |
| 7 | Stopping Plate            |
| 8 | Rope                      |

**NOTE:** Refer to the actual product

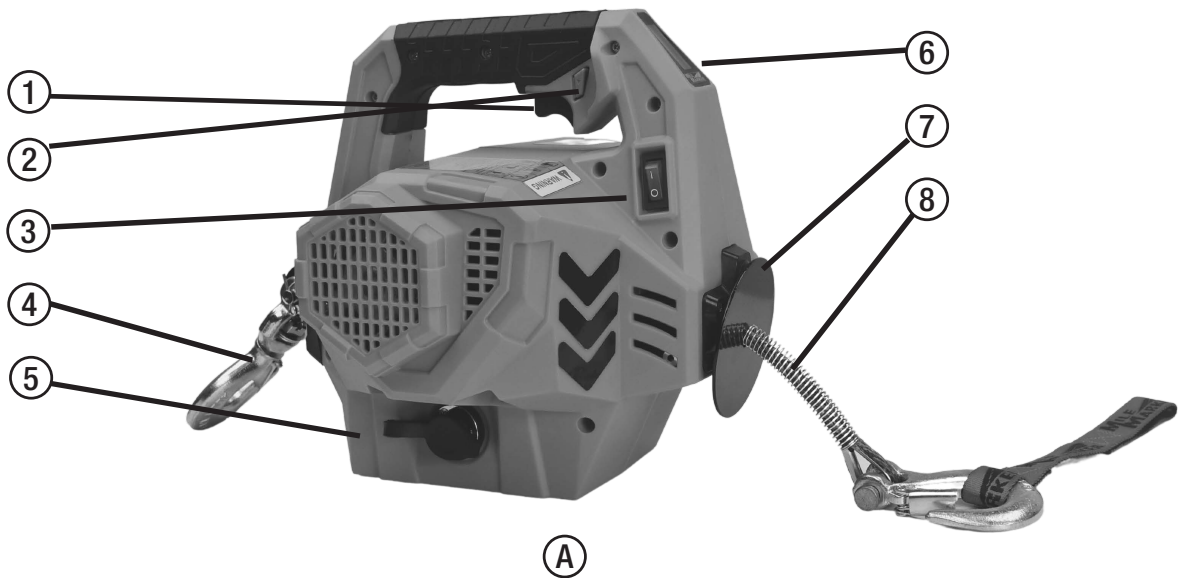

## Included Accessories

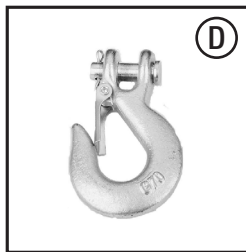

| ITEM NUMBER | ITEM DESCRIPTION | QUANTITY |
|-------------|------------------|----------|
| A           | Winch            | 1        |
| B           | Battery          | 1        |
| C           | Charger          | 1        |

| ITEM NUMBER | ITEM DESCRIPTION  | QUANTITY |
|-------------|-------------------|----------|
| D           | Hook              | 1        |
| E           | Remote            | 1        |
| F           | 12.5' Remote wire | 1        |

# DISPLAY SCREEN

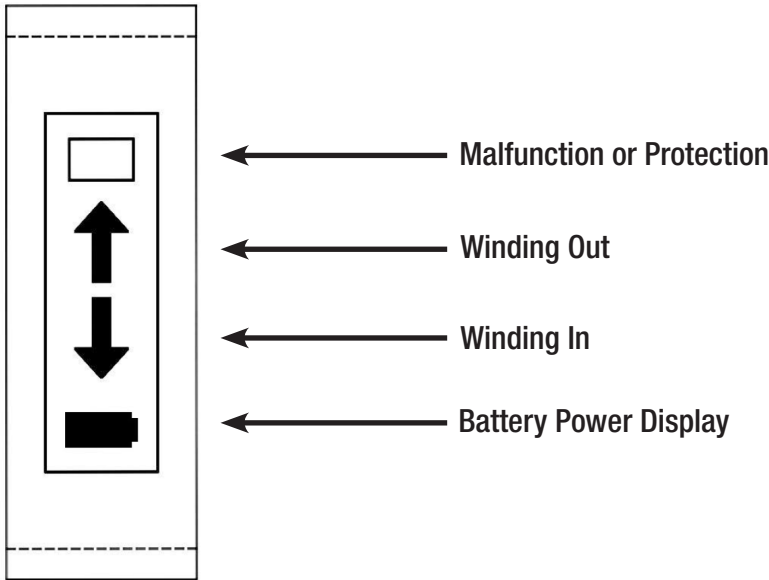

1. Display of battery power: three grids are green. When the battery power displays only one grid, please charge it soon.
2. Pulling out rope and winding back rope status indicator are displayed in the code #'s.
3. When the below codes appears, please solve the problem according to the following table.

| ERROR CODE | PROBLEMS                                 | SOLUTION   |
|------------|--|--|
| Sign !     | The load reaches 80% of the setting load | Remind the user of the weight  |
| Code 1     | Winch stops working                      | The load reaches the setting protection load; you need to reduce the weight  |
| Code 2     |  | The motor temperature reaches the maximum temperature; Stop using portable winch and let it cool to room temperature before using it again |
| Code 3     |  | Maximum current reached, fuse brakes; contact customer service   |
| Code 4     |  | Stopping limit reached; stop winding rope  |

4. When the battery temperature reaches the set temperature, the product stops working and enters the protection state.

**NOTE:** Sometimes, the product will stop working because it has entered protection mode. At this point, please refer to the error code to reset the product.

# BATTERY INSTALLATION

## Battery installation and unloading

- During the installation, please confirm that the power switch is at “OFF/O” position. Battery release button must be at the top, align the contact point of the battery against the corresponding contact point on the battery slot, slide the battery in, and gently press until the battery is locked in place.
- When removing the battery from portable winch, confirm the power switch is in the “OFF/O” position." Press down the battery release button and remove the battery.

## Battery power

1. When the battery is installed in the portable winch, the battery status can be examined by removing the battery frame in the display screen on the fuselage.
2. There is a power display button and three LED power indicator lights on the top of the battery. After pressing the button, the battery status will be displayed:
  - Three LED lights are on and green, indicating a full battery.
  - One LED light is off, the other two are green. If the indicator does not flicker, the power level is between 40% and 70%.
  - If the indicator light is red, please charge as soon as possible.

**REMINDER:** Turn off winch when finished. If the battery is drained completely, it may be nonchargeable, voiding the warranty on the battery.\*

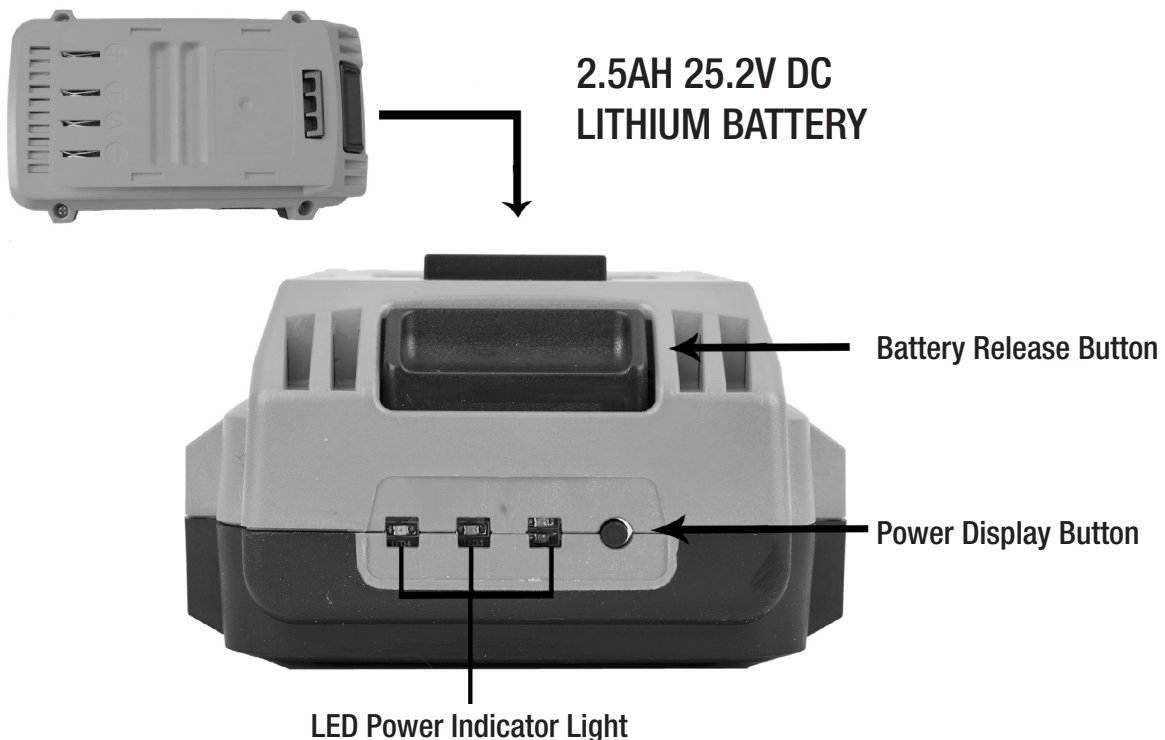

# CHARGER

You need to use the original charger to charge the battery. After the battery is loaded into the portable winch, insert the power cord of the charger into power outlet, and then insert the plug of the charger into the charging port of the portable winch:

- When the red light on the charger light up, the battery is charging.
- When the red light turns green, battery has been fully charged. If the battery is not fully discharged, the light will turn green in a short time.

When the charger is not in use, please unplug the charger from the power outlet. A charger connected to the power outlet will consumes power even if it is not connected to portable winch. The battery will be hot when charging, before using portable winch, let the battery cool to room temperature.



## Protection Functions:

1. Short circuit protection:  
The power value of short circuit protection:  $\leq 3$  W, the battery supply appliance can resume normal operation when the short circuit is fixed
2. High current protection:  
High current protection value:  $I < 1.8a$ , the power supply will automatically return to normal operation after current value return to normal.

## Quick Charging Function:

The charger can fully charge a battery in two hours.

# CHARGER

## WARNING

- Make sure the winch is turned off when charging, this could avoid damaging the winch and battery.
- Never use portable winch while charging.
- When the battery temperature is higher than 70 °C (158 °F) or below -20° C (-4° F), the battery will stop discharge in order to protect the battery, you need to wait for the battery to cool down to room temperature before using the product again.
- Please do not charge the battery when the ambience temperature is above 50° C (122° F) or lower than 0° C (32° F).
- It takes two hours to charge. When the battery is fully charged, be sure to disconnect the charger.
- If the battery is flooded or damaged, it cannot be charged.
- Never charge or use battery in a dangerous environment, for example close to flammable liquids, gases or dust.
- Never store the battery in an extreme environment, or it will damage the battery.
- Never open the battery pack. If the battery pack is broken, please stop using it immediately, don't charge the battery and then replace the battery.
- While not using the machine, please place the power switch in OFF /0 position to save power.
- Charge the battery before it runs out of power, which can help extend battery life.
- Disposal or recycling: please dispose of waste batteries according to local laws and regulations.

### If the battery can't charge normally

1. Insert other electrical equipment and check the voltage of the power outlet.
2. Confirm the charger voltage is about 29.4V DC. See the charger pin here or on the charger label.
3. Check the battery terminal for dirt. If so, clean with a cotton swab and alcohol.
4. If you still can't charge the battery, please contact the customer service.



# REMOTE CONTROL

## Wired Remote Control:

1. Connect the wire: Plug the 4 pin socket to the end of remote control, plug the 5 pin socket to the portable winch.
2. Turn on the portable winch, press IN or OUT button to operate it.

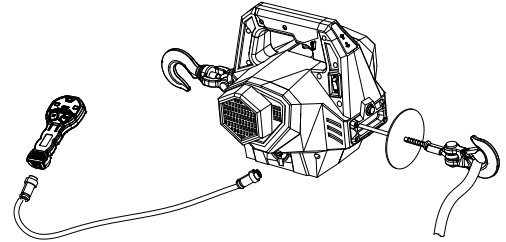

## Wireless Remote Control:

1. To start, press and hold ON/OFF button for 2-3 seconds. The red LED will rapidly flash indicating that the portable winch is in operation.
2. To stop, press the ON/OFF button for 3 seconds. Or it will be stopped automatically in 3 minutes if there has been no winching activity.

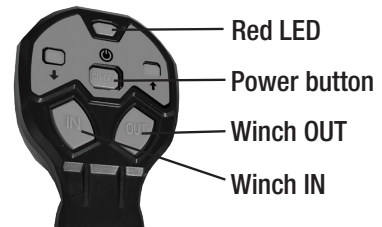

## Resetting Learning Function:

If the transmitter needs to be replaced, carryout the following steps to match the new transmitter to the receiver.

1. Press and hold ON/OFF button until finishing the step 2. (Ensure the portable winch is off)
2. Turn on the portable winch until the LED screen shows two arrow marks, now the reset learning function is completed.

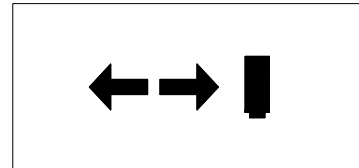

## Battery Replacement:

1. Remove the four screws from the back of wireless transmitter.
2. Separate the cover and remove the old battery.
3. Insert a new A23 battery (L1028F). Rejoin the cover ensuring alignment is correct and the four screws are tight.

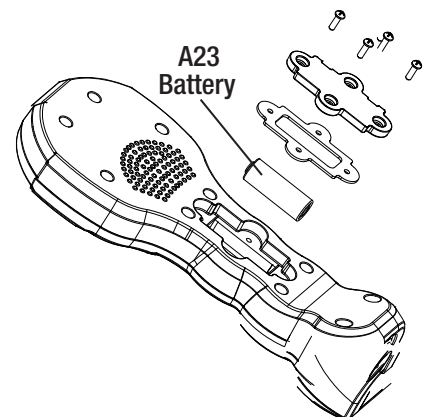

# OPERATION

Before using this winch to lift or pull a load, you should familiarize with your winch. It is important to know how it works.

This winch is a portable tool for lifting and pulling. This powerful tool has a power switch, a directional switch and a speed controller. The directional switch controls the forward and reverse rotation of the drum. The speed controller can change the speed when winding in or out.

**NOTE:** When spooling out or rewinding the rope, it is necessary to keep a tension on the rope to prevent bind and entangle the rope, causing damage to it and the tool. Do not spool out anymore when you see the red paint on the rope. Always keep at least 5 wraps of rope around the drum. Avoid spooling the drum in the wrong direction. Never spool the rope out past the red painted on the rope.

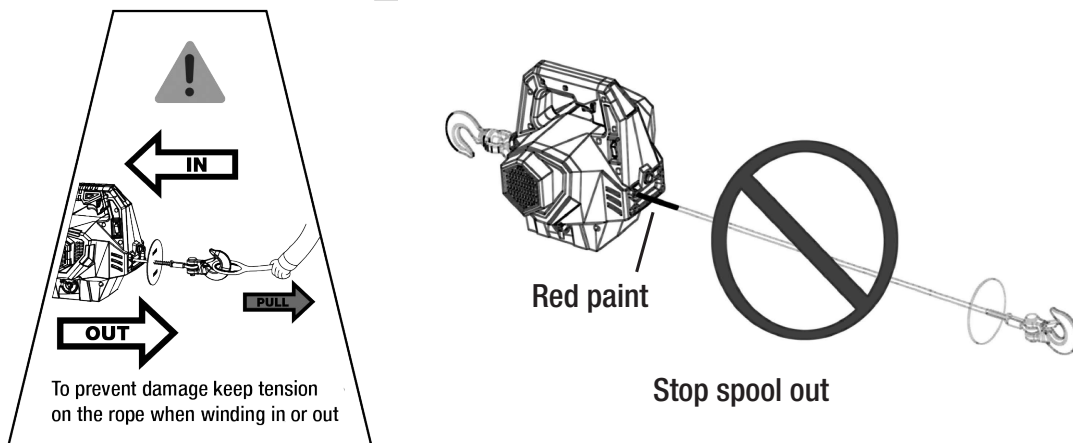

**The following situations will cause the system to enter the protection state automatically:**

1. At 90% of the pulling capacity the overload indicator would read Code 1
2. The battery is overheating
3. Low battery

**When this occurs, please follow these steps :**

1. Turn off the power switch.
2. Remove the battery.
3. Overload: Release the loading or increase the distance of the anchor point or use a snatch block to increase the pulling power.  
Overheating: Allow the battery to cool to room temperature.  
Low battery: Charge the battery.
4. Install the battery back into the product.
5. Turn on the power switch.

The portable winch is now ready to be operated again.

# OPERATION

Take some time and practice using it before pull or lift a load, that way you will be familiar with all the operations.

The following steps describe how to use the tool with single rope. A snatch block can improve the pulling capacity.

1. Put on gloves and attach the strap to the hook.
2. Install the battery. Make sure the position of power switch is at "OFF/O". Put the battery into this product, ensure the latch is fully engaged.
3. Power on the winch. Turn the power switch to the position "ON/I". Always turn the power switch to "off" when not in use.
4. Spool out. Press the directional switch to "▲", then press and hold the speed controller. Always keep some tension on the rope to prevent bind and entangle the rope, causing damage to it and the product. Never spool the rope out past the red painted on the rope.  
**\*The distance of usable rope 11.5m or 37.5 ft\***

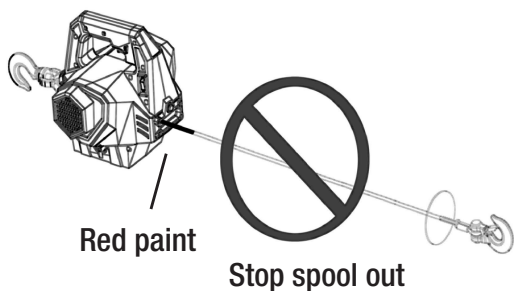

5. Secure an anchor point using the swiveling anchor hook to attach the anchor point. Always make sure that the anchor you intend to use is capable of withstanding the load. Never hook the rope back onto itself. This could damage the rope. A tree saver or choker chain is recommended.

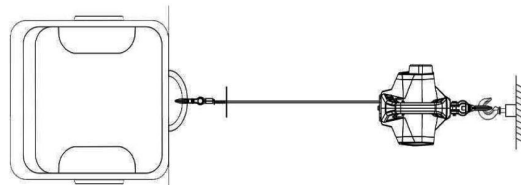

6. Attach your load. Establish a load point. Use a shackle or strap when attaching the hook to you load. Always use a hook with a latch and insure hook latch is secure.

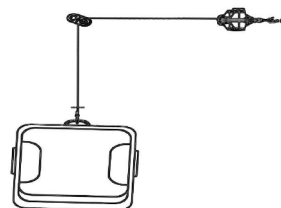

7. Give the rope some tension. Press the directional switch to "▼", then press and hold the speed controller to slowly wind the rope until the rope is winded tightly. Never touch rope or hook while in tension or under load.
8. When pulling, put a damper, blanket or other heavy duty material over the rope.

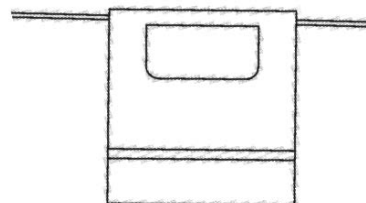

# OPERATION

9. Plan to pull or lift. Ensure all the connections are secured. Line up your pulling direction as straight as possible. Side pulls can cause the rope to bunch at one side of the drum, causing damage to the rope and the product.
10. Start pulling or lifting. Press the directional switch to “▼”, then press and hold the speed controller to wind in the rope. Never exceed pulling capacity listed on product data sheet. Double the rope number using a snatch block to reduce load.
11. Disconnect the hook from load and anchor point. Be sure to secure the load completely. Press the directional switch to “▲”, then press and hold the speed controller, release tension in the rope. Disconnect the hook from the load and anchor point.
12. Rewind rope. Press the directional switch to “▼”, then press and hold the speed controller to slowly wind in the rope. Always keep tension on the rope to prevent binding and entangling, causing damage to it and the tool. Do not let rope slide through your hand.
13. Turn off the pulling tool. Make sure the position of power switch is “OFF/O”. Store in a clean and dry place and avoid children to contact and play.

**The operation is now complete.**

Snatch Block can reduce load

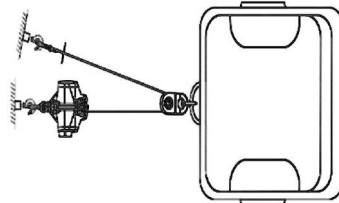

## **NOTE: Considerations for using this product**

- Always take time to check the load and determine whether the load is within the specified load range of the product.
- Always check the product for malfunction and battery status.
- Always wear gloves to prevent injury of hands caused by rope.
- Always pay attention to the safety of yourself and people around you.
- Practice over and over again.

# TROUBLESHOOTING

| NUMBER | PROBLEM   | SOLUTIONS  |
|--------|---|--|
| 1      | The product failure light (red light) lights up and flashes                             | This indicates the load reaches more than 80% of the rated load, which needs attention.                              |
| 2      | The product stops working, and the temperature is too high.                             | Stop using pulling tool until the motor cools to room temperature.   |
| 3      | Product stops working   | Please check battery power. If power is low, please charge it.   |
| 4      | Product stops working (display code)  | Exceeds the rated load. Try to reduce the load.  |
| 5      |   | The current is too big, resulting in damaged fuse brakes. The fuse needs to be replaced or contact customer service. |
| 6      | Drum sound when laying or winding rope  | The rope on the drum is wound together, you need pull the rope out and rewind it.                                    |
| 7      | After operating according to charging requirements, the battery still can't be charged. | Check if power socket is the problem. If so, replace the socket.   |
| 8      |   | Check surroundings.  |
| 9      |   | Check whether the charger and battery are faulty. If so, please purchase a new one or contact customer service.      |
| 10     | Water damage  | Return to factory for repair.  |
| 11     | Remove protection   | Close the portable winch, unplug the battery, reload, and restart the winch.   |

## Product Maintenance

Both portable winch, accessories and rope must be carefully maintained to prevent damage and wear after use. If the rope is damaged, it is recommended not to use it. Replace it as soon as possible. It is very dangerous to use damaged rope. Before using, it is best to examine portable winch and battery parts carefully. Battery components also need to be inspected or replaced regularly to make sure they are not damaged. If you have any other questions, we welcome your inquiries at any time.

# SPECIFICATIONS



| SPECIFICATIONS         |  |
|------------------------|--|
| Rated Line Pull        | 1000 lbs. (454 kgs)                          |
| Battery Power Supply   | 24V DC                                       |
| Rope                   | 5 mm X 12 m                                  |
| Battery                | Lithium Battery                              |
| Battery Capacity       | 2.5AH  |
| Battery Charger Input  | 100-240V AC 50-60 Hz 75 W                    |
| Battery Charger Output | 30 V = 2000 mA                               |
| Dimensions             | 24" X 10" X 10.5" (610 mm X 256 mm X 267 mm) |
| Net Weight             | 16.8 lbs. (7.6 kgs)                          |

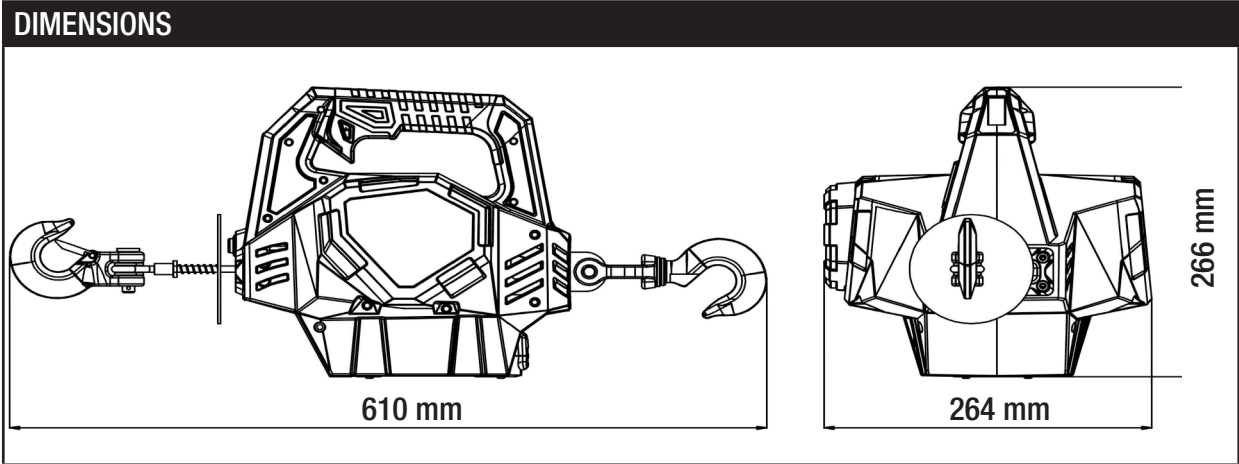

# ADDITIONAL ACCESSORIES



**Replacement Battery**  
PN 71-1000-29



**Replacement Wall Plug**  
PN 71-1000-43



**Replacement Wireless Remote**  
PN 71-1000-44



**Replacement Remote Wire**  
PN 71-1000-45



**ATV 1'x8' Tow Strap**  
PN 19108

# LIMITED WARRANTY

## Mile Marker Portable Winch Limited 1-Year Warranty

Mile Marker Industries warrants to the original purchaser that the mechanical components and electrical components of the Rhino Pull 1000 portable winch will be free of defects in material and workmanship for a period of one (1) year from the original date of purchase. Rechargeable batteries included with products are warranted to be free of defects in material and workmanship for a period of ninety (90) days from the original date of purchase. This Warranty applies only to the original purchaser of the Products.

Product registration must be submitted at [MileMarker.com/warranty](http://MileMarker.com/warranty) within 30 days of purchase by the end user. If you discover a defect, Mile Marker will, as its option, replace the product or repair the necessary parts at no charge to you, provided you return it prepaid to Mile Marker Industries. If the product was purchased in the United States, the owner must contact our warranty department to get a Return Goods Authorization (RGA) number before returning the product. If the product was purchased outside the United States, the owner must return the product to the original place of purchase.

For full warranty and general warranty procedure and policy visit: [MileMarker.com/warranty](http://MileMarker.com/warranty)



**MILEMARKER.COM**

INFO@MILEMARKER.COM

1-800-886-8647

2121 BLOUNT ROAD POMPANO  
BEACH, FL 33069