

Installation Manual

VERSION
FRANÇAISE



AIR SUSPENSION KIT

Chevrolet Silverado / GMC Sierra 2500 HD/3500 (2WD/4WD)*

** Not for commercial chassis cabs.*

Use the most advanced air springs on the market to eliminate your vehicle's sag, sway and bottoming out. This heavy duty air suspension kit levels your truck's stance while providing added support for an overall smooth and safe ride.

** See application guide for proper fitment.*

L5683_REV13_02.21.2024

Thank you and congratulations on the purchase of an Air Suspension kit. Please read the entire manual prior to starting the installation to ensure you can complete it once started.

IMPORTANT

This air suspension kit will not increase the GVWR (*Gross Vehicle Weight Rating*), as the GVWR is determined by the vehicle manufacturer. **Do not exceed the maximum capacity listed by the vehicle manufacturer.**

For safe and proper operation of the vehicle, never exceed a maximum of 100PSI in the air springs. Staying under the pressure limit will ensure maximum air spring life. **Failure in doing so may result in damage to your vehicle and/or a void warranty.**

SAFETY WARNINGS!

! Please read and abide the instructions found in this manual, paying close attention to the helpful, cautionary or dangerous warning icons highlighting important safety recommendations and maintenance suggestions throughout this manual.

+ **HELPFUL INSTALL TIP**
Additional information that could potentially make the job a little easier.

! **PLEASE USE CAUTION**
Unsafe practices could result in damage to you or your vehicle, or others.

! **DANGER WARNING**
Hazards which could result in severe personal injury or death.

! Serious personal injury or death may result from an air spring failure or accident due to improper installation or air spring pressure operation or maintenance.

! Inflating an unsecured air spring is dangerous. If it bursts, it could be hurled into the air with explosive force resulting in serious personal injury or death. Never inflate an air spring unless it is secured to the vehicle.

! Removing and replacing air springs can be dangerous. This is only a job for a qualified service professional. Never perform air spring service procedures without proper training, tools, and equipment.

BEFORE STARTING THE INSTALLATION

- Ensure the application information is correct for the make, model and year of the vehicle you are installing the kit on.
 - Some vehicles are equipped with a rear wheel brake proportioning valve. Check with the manufacturer before installing the air spring kit, as it may affect braking performance.
 - It is recommended to use a good quality anti-seize on all fasteners. This will reduce the chance of corrosion on the fasteners and will help facilitate removal, if required at a later date.
- !** **PLEASE NOTE:** This kit contains push-to-connect fittings; using scissors or wire cutters to cut the nylon air line will distort the line and cause the connection to leak. The air line must be cut off squarely with the hose cutter provided in this kit, or a sharp utility knife. **Failure to do so may void the warranty.**

! **WARNING:** This product can expose you to the chemical Hexavalent Chromate, which is known to the State of California to cause cancer and birth defects or other reproductive harm. **For more information go to www.P65Warnings.ca.gov**

KIT CONTENTS

Please confirm the items below are provided in your kit before starting the installation.

HEAVY DUTY KITS		QTY	PART #
A*	Double Convoluted Spring	2	HP10000

HEAVY DUTY JOUNCE BUMPER KITS		QTY	PART #
A*	Double Convoluted Spring w/ Jounce Bumper	2	HP10000J

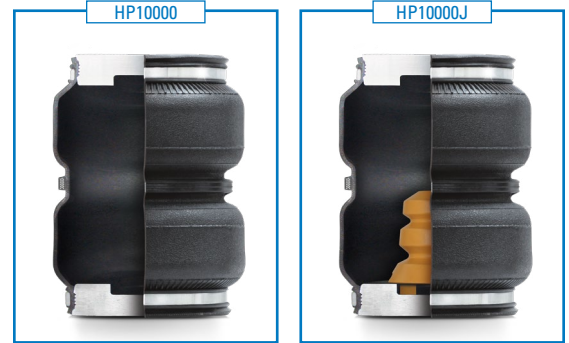

KIT CONTENTS		QTY	PART #
B	Upper Bracket	2	HP0010
C	Lower Bracket	2	HP1137
D	90° Fitting	2	HP1100
E	Roll Plate	4	HP10054
F	Heat Shield	1	HP0012
G	3/8" Nylock Nut	10	HP1000
H	5/16" Nylock Nut	2	C11943
I	3/8" Flat Washer	23	C653
J	Air Line/Valve Assembly	1	HP1344
K	3/8" Lock Washer	4	C18007
L	3/8"-24 x 7/8" Bolt	4	HP1002
M	3/8"-16 x 3/4" Bolt	2	C11571
N	3/8"-16 x 1 1/2" Bolt	4	C18018
O	3/8"-16 x 3" Bolt	4	HP1003
P	5/16"-18 x 1" Bolt	1	C11819
Q	3/8"-24 x 3/4" Flat Head Screw	4	HP1008
R	5/16"-18 x 7/8" Clinch Stud	1	HP1007
S	5/8" Clamp	1	HP1006
T	Axle Strap	2	HP0009
U	Lower Brake Bracket	1	HP0011
V	Heat Shield Clamp	2	HP1001
W	Tie Strap	6	C11618



REQUIRED TOOLS

- Hoist or Floor Jack
- Safety Stands
- Safety Glasses
- Torque Wrench
- Standard Combination Wrenches
- 7/32" Hex Allen Wrench
- 1-1/8" Wrench or Deep Socket
- Ratchet
- Metric & Standard Sockets
- Hose Cutter (included) or Sharp Utility Knife
- Pipe Thread Sealant
- Spray Bottle with Dish Soap/Water
- Air Compressor/Compressed Air Source (to test/fill air springs)

INSTALLATION INSTRUCTIONS

1 MEASURE STOCK RIDE HEIGHT

Park the vehicle on a level surface.

Using a measuring tape, measure the distance between the center of the wheel hub and the bottom of the fender well (as shown in Figure 1) this will give you your ride height.

Note the ride height for all four corners.

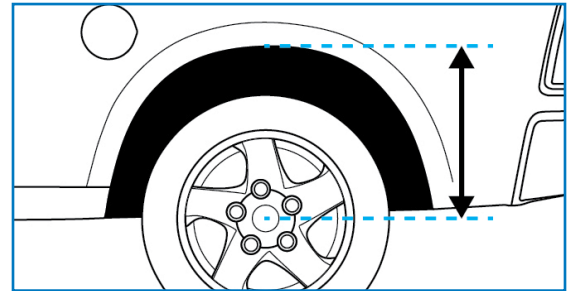

1

2 REMOVE REAR WHEELS

Place wheel chocks in front of and behind both front wheels.

Raise the rear of the truck high enough to remove both wheels and attain a comfortable working height.

Place two jack stands under rear axle (shown in Figure 2).

Lower the vehicle until the axle is supported by the jack stands.

Remove rear wheels.



2

3 UPPER ROLL PLATE ASSEMBLY

Place the upper roll plate on top of the air spring as shown in Figure 3A. The top side of the air spring is the one with the air port (highlighted with an arrow in Figure 3A).

Repeat on the other air spring.

Install the air fittings into the inlet ports of the air springs (as shown in Figure 3B). It is recommended to use thread sealant to prevent air leaks.

The air spring ports will be installed towards the center of the vehicle.

The passengers side fitting will point towards the front of the vehicle.

Do not over tighten the fittings.

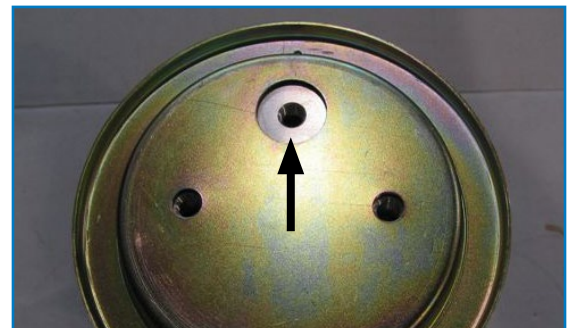

3



3B

4 UPPER BRACKET ASSEMBLY

Place the upper mounting brackets on top of air springs aligning the two mounting holes, using Figure 4 and below notes as reference, for each assembly:

- ❗ **The driver side bracket mounts to the air spring through the elongated holes on each side of the air inlet port cutout.**
- ❗ **The passenger side bracket mounts to the air spring through the elongated holes opposite the air inlet port cutout.**

Install the two capscrews, lock and large flat washers loosely to secure the mounting bracket to the air spring.

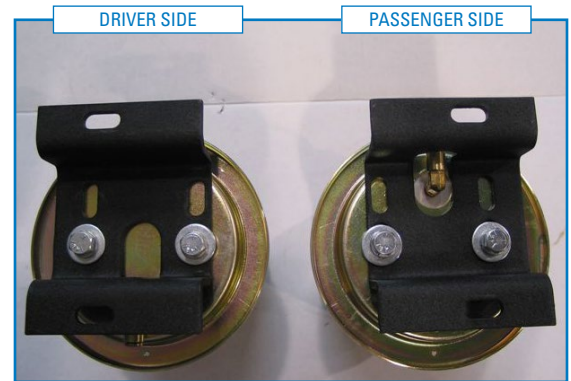

4

5 LOWER BRACKET ASSEMBLY

Install the clinch stud into the driver side lower bracket hole, (as shown in Figure 5A with an arrow). This is an interference fit into the bracket.

Tighten the nut securely.

A clinch stud is not required on the passengers side lower bracket.

- ❗ **2500 MODEL ONLY: (3/4 ton trucks) require a 3/8" bolt and nut to be installed in both lower brackets as shown in Figure 5B. The bolt head is installed opposite the air spring. The nut will fit inside the roll plate cavity.**

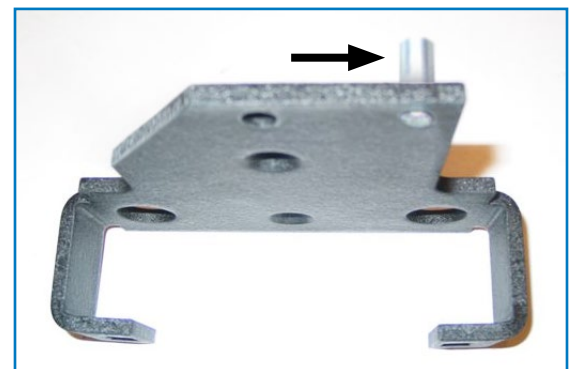

5A



5B

6 LOWER ROLL PLATE ASSEMBLY

Place the lower roll plate on the bottom of the air spring.

Install the two carriage bolts through the square holes in the "legs" of the lower bracket, as shown with arrows in Figure 6. The threaded end of the carriage bolts should point away from the air spring (see Figure 6 for reference).

- ❗ **PLEASE NOTE: The "legs" of the brackets must be installed towards the outside of the vehicle.**

Install the lower bracket onto the air spring, using the two countersink capscrews and a 7/32" allen wrench. Tighten the countersink capscrews securely.

Repeat on the other air spring.

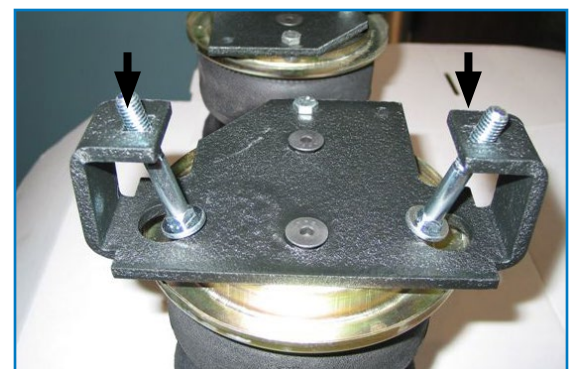

6

7 JOUNCE BUMPER REMOVAL

Remove the jounce bumpers on both sides and discard.

- ⓘ **2500 MODEL ONLY:** (3/4 ton) may have a nut and bracket welded to the axle tube. It must be removed if interference exists with the lower air spring bracket.

8 INSTALL AIR SPRING ASSEMBLY

Insert the air spring assembly between the jounce bumper and the axle plate.

- ⊕ Some vehicles may require the axle to be lowered or raised slightly to attain enough clearance to insert the air spring assembly.

Rotate the lower mounting bracket to position so one leg is in front and the other leg is behind the axle plate.



8



9

9 ATTACH UPPER BRACKET

Install the upper bracket to the frame using the holes of the jounce bumper with the 4 cap screws, 8 flat washers and 4 nylock nuts supplied.

Torque to 27 N•m (20 lbs.ft.)

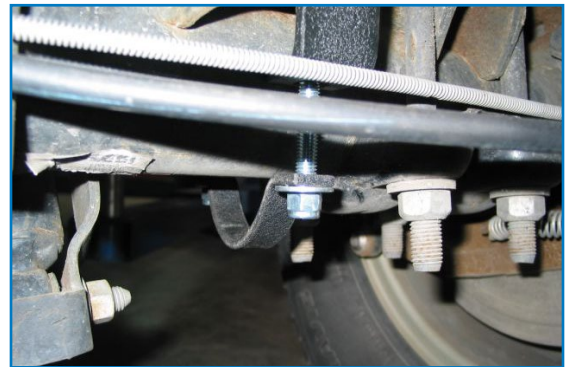

10

10 INSTALL THE AXEL STRAPS

Loosely install the 2 axle straps with the 4 nylock nuts and 3/8" flat washers supplied.

11 ALIGN AIR SPRINGS

Adjust the air spring to the upper bracket and the lower bracket on the axle tube to ensure the air spring is aligned, as shown in the diagram.

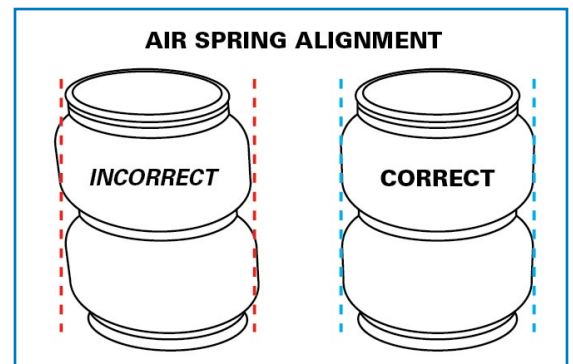

11

12 CHECK CLEARANCE

Ensure sufficient clearance exists between the brake lines and carriage bolts.

Once alignment is correct, tighten the upper bracket to the air spring capscrews.

Then tighten the 2 carriage bolt nuts to the axle straps to 27 N•m (20 lbs.ft.).

Repeat on the other air spring.

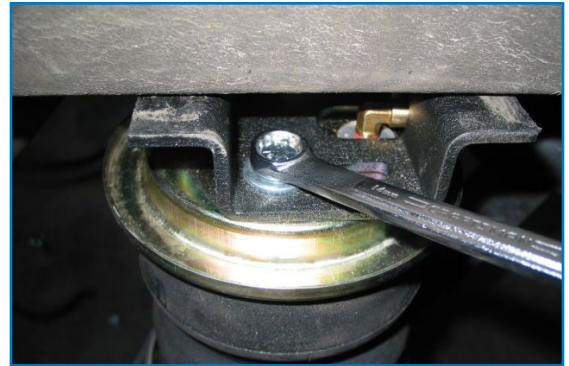

12

13 SECURE EMERGENCY BRAKE CABLE

Install the bracket supplied to the clinch bolt on the drivers side lower air spring bracket, (previously installed in Step 5), using the 5/16" x 1" bolt, nylock nuts and flat washers provided.

This is to secure the emergency brake cable away from the air spring assembly.



13

14 INSTALL HEAT SHIELD

Bend tabs on the heat shield so the required 1/2" of dead space exists between the heat shield and exhaust when attached.

Attach the heat shield to the exhaust pipe on passenger side using two ring clamps (shown in Figure 14 on the following page).

Each hose clamp holds a tab against exhaust pipe.

Installation continues on the following page.



14

INSTALL AIR LINE

Two fill valves are provided in this kit. The most common place to install them is in place of the license plate fasteners. Alternatively, two 5/16" holes can be drilled in a location of your choosing.

Cut the air line assembly into two equal lengths with the hose cutter provided in this kit or a sharp utility knife.

! **PLEASE NOTE:** *This kit contains push-to-connect fittings; using scissors or wire cutters to cut the nylon air line will distort the line and cause the connection to leak. The air line must be cut off squarely with a hose cutter or a sharp utility knife.*

Install one air line at a time starting at the fill valve location. Place a 5/16" nut on the air valve. Leave enough of the inflation valve in front of the nut to extend through the hole, install a flat washer, and 5/16" nut and cap (reference Figure A for assembly). There should be enough valve exposed after installation – approximately 1/2" – to easily apply a pressure gauge or an air chuck.

Route the air line back to the NPT fitting on the air spring, then cut the hose to length. Moisten the end of the air line prior to inserting it into the fitting and push it in until it stops.

Repeat with the other fill valve.

Secure the air lines using the provided tie-straps, away from any moving items and heat sources.

CHECK SYSTEM FOR LEAKS

Inflate both air springs to 90 psi and then use a mixture of dish soap and water on all air line connections to detect any air leaks. Large, expanding bubbles indicate a leak (as shown in Figure B).

Repair as necessary and retest.

Inflate air springs to a predetermined value and on following day recheck pressure. If one or both of air springs have lost pressure, an air leak is present.

! **Leak must be repaired, and then retested until no leaks exist.**

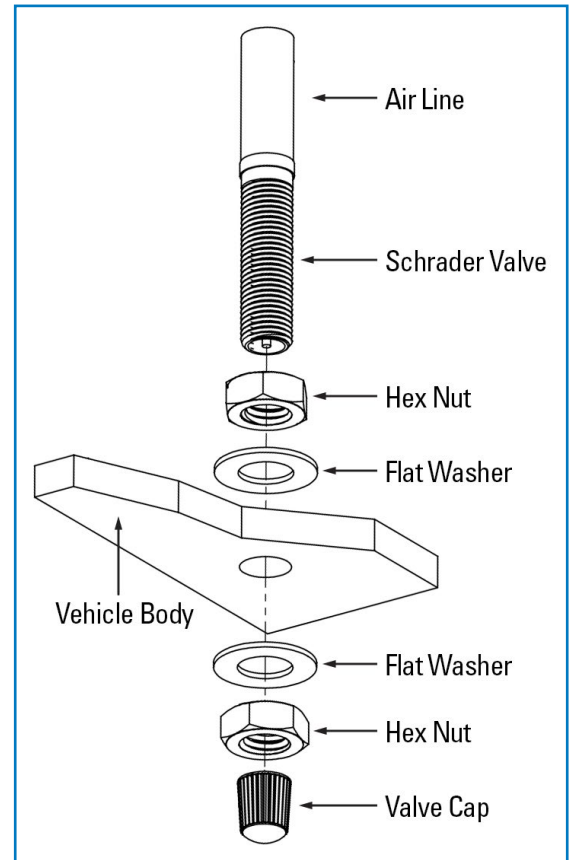

A

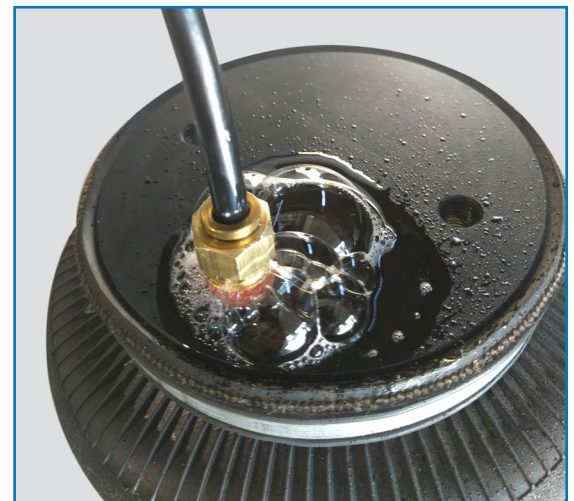

*Air Spring & NPT Air Fitting may differ between kits

B

CONGRATULATIONS! You have completed the install

After Installation continues on the following page.

.....

Thank you again, and congratulations on the installation of your Air Suspension kit.

AFTER COMPLETING THE INSTALLATION

- The air spring must have clearance between itself and the surrounding components to prevent any contact when spring is inflated or compressed. Trimming off excess bolt length may also be required to ensure no contact with the spring or other suspension components can be made once installed.
- If removed, re-install the wheels and torque fasteners to the manufacturer’s specifications. Re-torque all fasteners after the first 500 miles of driving.

OPERATING YOUR VEHICLE WITH AIR SUSPENSION

Air springs have minimum and maximum recommended pressure requirements:

PART #	SPRING STYLE	SPRING TYPE	MIN PSI	MAX PSI
HP10189	In-Coil	STANDARD DUTY	5 PSI	70 PSI
HP10560		STANDARD DUTY		
HP10001	Sleeve Style	STANDARD DUTY	10 PSI	100 PSI
HP10173		STANDARD DUTY		
HP10199		STANDARD DUTY		
HP10083	Single Convoluted	HEAVY DUTY	5 PSI	100 PSI
HP10083J		HEAVY DUTY with JOUNCE BUMPER	0 PSI* / 5 PSI	100 PSI
HP10000	Double Convoluted	HEAVY DUTY	5 PSI	100 PSI
HP10000J		HEAVY DUTY with JOUNCE BUMPER	0 PSI* / 5 PSI	100 PSI
HP10068	Large Double Convoluted	HEAVY DUTY	5 PSI	100 PSI
HP10438	Double Convoluted	EXTREME DUTY	5 PSI	100 PSI
HP10438J		EXTREME DUTY with JOUNCE BUMPER	0 PSI* / 5 PSI	100 PSI

** Springs with a jounce bumper can be run at zero PSI when vehicle is unloaded only*

For safe and proper operation, never operate the vehicle over the maximum listed PSI in the air springs. Staying under the pressure limit will ensure maximum air spring life. **Failure in doing so may result in damage to your vehicle and/or a void warranty.**

! It is recommended to check the air pressure in your air springs daily for first couple of days to ensure a leak has not developed.

Air springs are designed to maintain the vehicle’s stock ride height with a load. Do not use the air springs as a means to lift vehicle with no load. This will result in a harsh ride.

SERVICING YOUR VEHICLE WITH AIR SUSPENSION

When lifting the vehicle with a floor jack or hoist on the frame, never allow the air spring to limit the travel of the axle. Try to always jack the vehicle on the axle. Suspending the axle with the air spring limiting the axle travel will damage the air spring and void the air spring warranty.

WARRANTY

See additional warranty included with this kit for details.