

# Installation Manual



## 10181 & 10182 KITS

Ford F-250 & 350 Pickup (2WD/4WD)\* (including in-bed hitch)  
(NOT FOR USE WITH CHASSIS CAB)

*Use the most advanced air springs on the market to eliminate your vehicle's sag, sway and bottoming out. This heavy duty air suspension kit levels your truck's stance while providing added support for an overall smooth and safe ride.*

\* See application guide for proper fitment.

L6220\_REV8\_07.17.2023



**WARNING:** This product can expose you to the chemical Hexavalent Chromate, which is known to the State of California to cause cancer and birth defects or other reproductive harm. *For more information go to [www.P65Warnings.ca.gov](http://www.P65Warnings.ca.gov)*

**IMPORTANT**

This air suspension kit will not increase the GVWR (*Gross Vehicle Weight Rating*), as the GVWR is determined by the vehicle manufacturer. **Do not exceed the maximum capacity listed by the vehicle manufacturer.**

***PLEASE NOTE: The air bag must have clearance between itself and the surrounding components to prevent any contact when bag is inflated or compressed. Trimming off excess bolt length is also required to ensure no contact with the bag or other suspension components can be made once installed.***

*Safety Warnings!*

- ❗ Serious personal injury or death may result from an air spring failure or accident due to improper installation or air spring pressure operation or maintenance. Please read and abide the instructions, safety recommendations and maintenance suggestions throughout this manual.
- ❗ Inflating an unsecured air spring is dangerous. If it bursts, it could be hurled into the air with explosive force resulting in serious personal injury or death. Never inflate an air spring unless it is secured to the vehicle.
- ❗ Removing and replacing air springs can be dangerous. This is only a job for a qualified service professional. Never perform air spring service procedures without proper training, tools, and equipment.



**KIT CONTENTS**

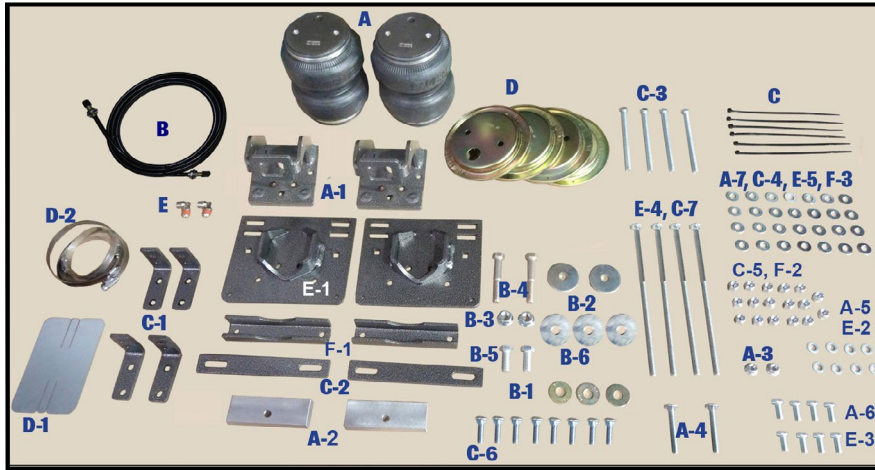

KIT CONTENTS		QTY	PART #
<b>SUBGROUP A:</b>			
<b>A-1</b>	Upper Bracket	2	HP1357
<b>A-2</b>	Spacer	2	HP1364
<b>A-3</b>	Serrated Flange Nut, 3/8" - 16	2	HP1338
<b>A-4</b>	Carriage Bolt, 3/8" - 16 x 2 1/2"	2	HP1003
<b>A-5</b>	Lock Washer, 3/8"	4	C18007
<b>A-6</b>	Hex Head Capscrew, 3/8" - 24 x 7/8"	4	HP1002
<b>A-7</b>	Flat Washer, 3/8"	4	C653
<b>SUBGROUP B:</b>			
<b>B-1</b>	Flat Washer, 1/2"	3	HP1368
<b>B-2</b>	Thick Flat Washer, 1/2" x 2" x 1/4"	4	HP1369
<b>B-3</b>	Serrated Flange Nut, 1/2" - 13	2	HP1370
<b>B-4</b>	Hex Head Capscrew, 1/2" - 13 x 3"	2	HP1324
<b>B-5</b>	Hex Head Capscrew, 1/2" - 13 x 2"	2	HP1459
<b>B-6</b>	Flat Washer, 1/2" x 2	3	HP1010
<b>SUBGROUP C:</b>			
<b>C-1</b>	4-Hole Locating Bracket	4	HP1374
<b>C-2</b>	Spring Clamp Bar	2	HP1373
<b>C-3</b>	Hex Head Capscrew, 3/8" - 16 x 5"	4	HP1372
<b>C-4</b>	Flat Washer, 3/8"	12	C653
<b>C-5</b>	Nylock Nut, 3/8" - 16	12	HP1000
<b>C-6</b>	Carriage Bolt, 3/8" - 16 x 1 1/4"	8	HP1149
<b>C-7</b>	Carriage Bolt, 3/8" - 16 x 10"	2	HP1329
<b>SUBGROUP D:</b>			
<b>D-1</b>	Heat Shield	1	HP0012
<b>D-2</b>	Hose Clamp, 4 1/2" - 6 1/2"	2	HP1377
<b>SUBGROUP E:</b>			
<b>E-1</b>	Lower Bracket, (HP10181) 4WD Kits	2	HP1353
	Lower Bracket, (HP10182) 2WD Kits	2	HP1391
<b>E-2</b>	Lock Washer, 3/8"	4	C18007
<b>E-3</b>	Hex Head Capscrew, 3/8" - 24 x 7/8"	4	HP1002
<b>E-4</b>	Carriage Bolt, 3/8" - 16 x 10"	2	HP1329
<b>E-5</b>	Flat Washer, 3/8"	4	C653

KIT CONTENTS		QTY	PART #
<b>SUBGROUP F:</b>			
<b>F-1</b>	Axel Straps	2	HP1383
<b>F-2</b>	Nylock Nut, 3/8" - 16	12	HP1000
<b>F-3</b>	Flat Washer, 3/8"	4	C653
<b>INDIVIDUAL PARTS</b>			
<b>A</b>	Air Spring	2	HP10000D
<b>B</b>	Air Line / Valve Assembly	1	HP1344
<b>C</b>	Tie Straps	6	C11618
<b>D</b>	Roll Plates	4	HP10054
<b>E</b>	90° Swivel Air Fitting	2	HP1100

**REQUIRED TOOLS**

- Hoist or Floor Jack
- Safety Stands
- Safety Glasses
- Torque Wrench
- Standard Combination Wrenches
- 7/32" Hex Allen Wrench
- 1-1/8" Wrench or Deep Socket
- Ratchet
- Metric & Standard Sockets
- Hose Cutter (included) or Sharp Utility Knife
- Pipe Thread Sealant
- Spray Bottle with Dish Soap/Water
- Air Compressor/Compressed Air Source (to test/fill air springs)

**BEFORE STARTING THE INSTALLATION:**

1. Ensure the application information is correct for the make, model and year of the vehicle you are installing the kit on.
2. Some vehicles are equipped with a rear wheel brake proportioning valve. Check with the manufacturer before installing the air spring kit, as it may affect braking performance.
3. It is recommended to use a good quality anti-seize on all fasteners. This will reduce the chance of corrosion on the fasteners and will help facilitate removal, if required at a later date.

**PLEASE NOTE:**

***This kit contains push-to-connect fittings; using scissors or wire cutters to cut the nylon airline will distort the line and cause the connection to leak. THE AIRLINE MUST BE CUT OFF SQUARELY WITH THE NYLON HOSE CUTTER PROVIDED IN THIS KIT OR A SHARP UTILITY KNIFE.***

**1 MEASURE STOCK RIDE HEIGHT**

Park the vehicle on a level surface.

Using a measuring tape, measure the distance between the center of the wheel hub and the bottom of the fender well (as shown in Figure 1) this will give you your ride height.

Note the ride height for all four corners.

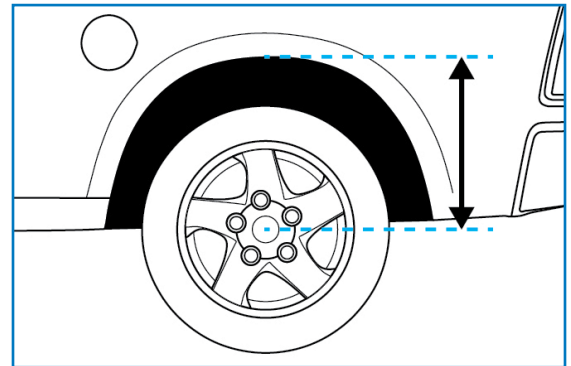

1

**2 REMOVE REAR WHEELS**

Place wheel chocks in front of and behind both front wheels.

Raise the rear of the truck high enough to remove both wheels and attain a comfortable working height.

Place two jack stands under rear axle (shown in Figure 2).

Lower the vehicle until the axle is supported by the jack stands.

Remove rear wheels.



2

**IMPORTANT NOTE:**

***If vehicle has pre-existing 5th wheel hitch, other than standard factory Reese hitch purchased with the truck at new, the 1/2" or 3/4" hardware mounting the side brackets will have to be removed to install the air spring kit.***



For Steps 3-4, use the parts in Subgroup E, as listed on Page 3.

### 3 ROLL PLATES

Set the roll plates on the bottom (2 holed surface) of the air springs, lining up the holes, (as seen in Figure 3A).

#### For SRW (Single Rear Wheel):

Insert one 10" carriage bolt into each lower bracket. The carriage bolt inserts into the top surface of the lower bracket through the square hole (as shown in Figure 3B with black arrows).

For the Driver side, insert the carriage bolt into hole (A).

For the Passenger side, insert the carriage bolt into hole (B).

#### For DRW (Double Rear Wheel):

Do not install the 10" carriage bolts at this time. They will be installed later in Step 11.

### 4 ATTACH A LOWER BRACKET TO EACH AIR SPRING

Attach a lower bracket to the air springs with two 3/8" - 24 x 7/8" hex head cap screws, two 3/8" lock and flat washers.

Make sure that the rounded edges of the bracket are on the same side as the large air fitting hole.

The lower bracket is positioned so that the bolts are threaded into the correct holes exactly as shown in Figures 4A & 4B.

**A = Driver Side** (Figure 4A)

**B = Passenger Side** (Figure 4B)

Torque to 20 ft-lbs, 34 N•m.

For Steps 5-7, use the parts in Subgroup A, as listed on Page 3.

### 5 ASSEMBLE A SPACER TO EACH UPPER BRACKET

Install a spacer to the each upper bracket with a 3/8" - 16 x 2½" carriage bolt, with the long side facing away from the bracket as shown in Figure 5 on following page.

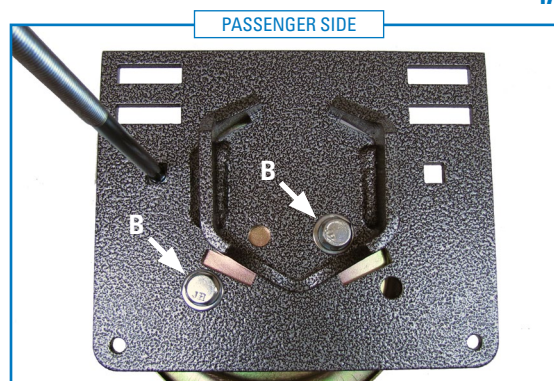
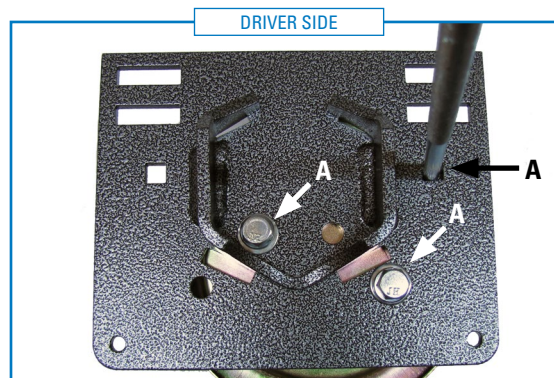
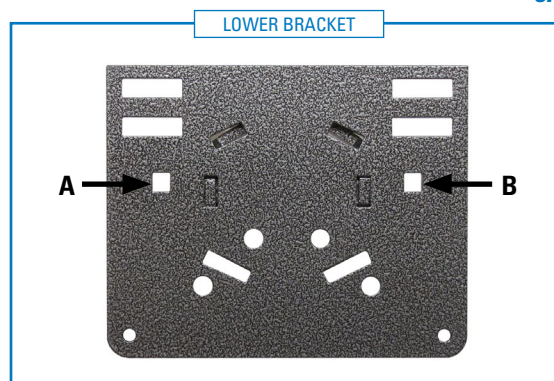

## 6 REMOVE THE JOUNCE BUMPER

Remove the jounce bumper (shown in Figure 6) from the frame by removing the nut holding the top of the jounce bumper to the frame using a 13mm wrench or socket.

## 7 ATTACH THE UPPER BRACKET TO THE FRAME

Attach the upper bracket and spacer to the frame, by inserting the 3/8"-16 x 2 1/2" carriage bolt through the hole in the bottom surface of the frame where the jounce bumper was attached (Shown with an arrow in Figure 7).

Loosely secure with a 3/8"-16 serrated flange nut. Do not tighten the nut as you will need to leave the bracket hanging to fit it to the top of the air spring. This nut will get tightened later in Step 10.

## 8 POSITION AND SECURE THE AIR SPRING ASSEMBLY TO THE UPPER BRACKET

Position a roll plate over the top surface of the air spring. Make sure that all three holes on the roll plate align with the openings on top of the air spring (as shown in Figure 8A).

Install an air fitting in the largest hole of the air spring (shown with an arrow in Figure 8A) using thread sealant or tape. Finger tighten plus one and a half turns.

Position the air spring assembly under the bottom surface of the upper bracket (see Figure 8B for reference) so that the holes in the roll plate align with the holes in the upper bracket.

Secure the air spring assembly to the upper bracket with two 3/8" - 24 x 7/8" hex head cap screws, two 3/8" lock and flat washers.

Make sure the upper bracket is positioned so that the bolts are screwed into the two smaller openings of the upper bracket.

Torque to 25 ft-lbs, 34 N•m.

### **IMPORTANT NOTE:**

*The bolt holes used for the Passenger side upper brackets are as shown in Figure 8C on the following page with **BLACK** arrows, using holes 1 & 3.*

*The bolt holes used for the Driver side upper brackets are shown in Figure 8C on the following page with **WHITE** arrows, using holes 2 & 4.*

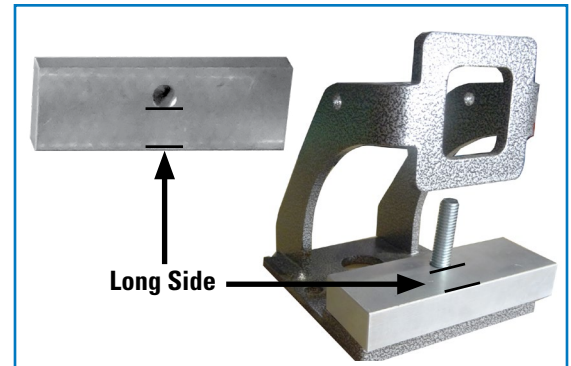

5

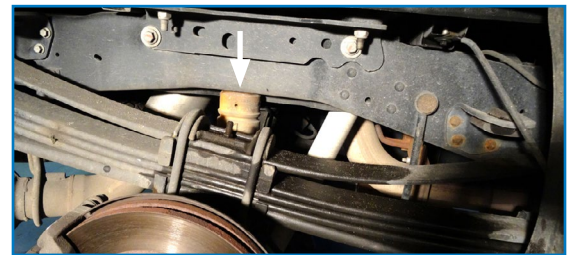

6

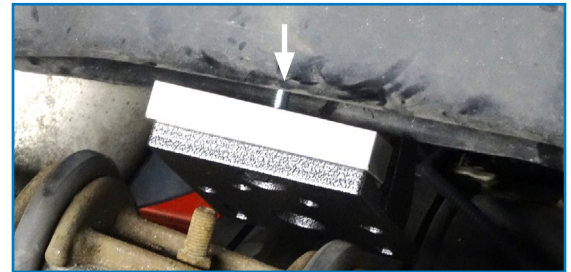

7

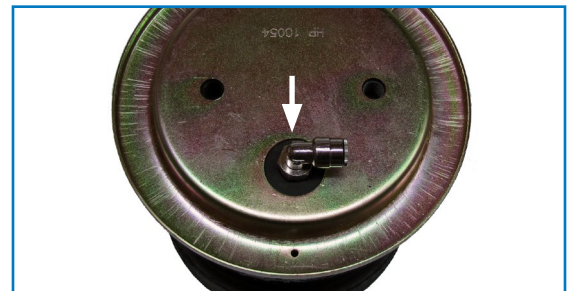

8A



8B



## 9 POSITION THE BOTTOM OF THE AIR SPRING ASSEMBLY ON THE JOUNCE BUMPER STRIKE PLATE

Align the bottom of the air spring and lower bracket assembly so the bottom curved surface of the lower bracket fits onto the jounce bumper strike plate, (as shown in Figure 9). The carriage bolts will be closest to the leaf pack on the truck.

### **IMPORTANT NOTE:**

*For 2WD models, the lower bracket will sit directly on the axle.*

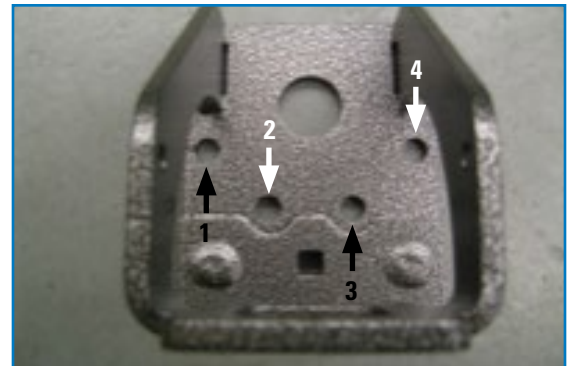

8C

For Step 10, use the parts in Subgroup B, as listed on Page 3.

## 10 SECURE THE TOP OF THE AIR SPRING ASSEMBLY TO THE FRAME

Torque the 3/8" serrated flange nut on the carriage bolt, which was loosely attached to the frame in Step 6, to 16 ft lbs, 22 N•m.

Fasten the top opening of the upper bracket to the inside surface of the frame (see Figure 10A). Using the supplied 1/2"-13 x 2" hex head cap screw with a 1/2" x 2" x 1/4" thick flat washer to go through the upper bracket. Add another 1/2" x 2" x 1/4" thick flat washer between the upper bracket and the frame and insert the rest of the screw through the frame. Cap with a 1/2"-13 serrated flange nut and a 1/2" x 2" thin flat washer on the outside (shown with an arrow in Figure 10B).

Torque to 27 ft lbs, 37 N•m.

### **\*For trucks with a FACTORY FIFTH WHEEL HITCH:**

Insert the supplied 1/2"-13 x 2" hex head cap screw with a 1/2" x 2" x 1/4" thick flat washer through the upper bracket. Add another 1/2" x 2" x 1/4" thick flat washer between the upper bracket and the frame and insert the rest of the screw through the frame. Cap with a 1/2"-13 serrated flange nut and a 1/2" x 2" thin flat washer on the outside.

### **\*For trucks with an AFTERMARKET FIFTH WHEEL HITCH WITH A BRACKET OR PLATE THAT RUNS ALONG THE SIDE OF THE FRAME AND USES THE FRAME SLOT TO SECURE ITSELF TO THE FRAME:**

Use the existing hardware that is holding the plate to the frame. Add a 1/2" x 2" x 1/4" thick flat washer in between the bolt and the air spring upper bracket.



9

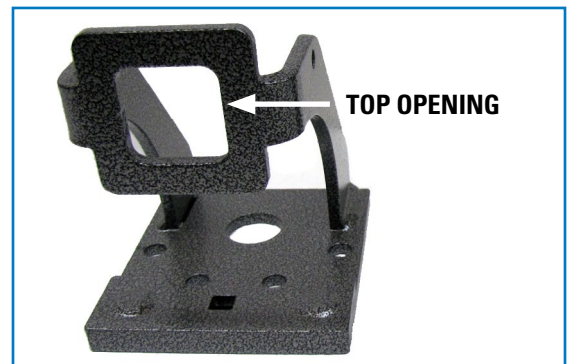

10A



10B

**\*For trucks with an AFTERMARKET FIFTH WHEEL HITCH WITH A BRACKET OR PLATE THAT RUNS ALONG THE SIDE OF THE FRAME BUT DOESN'T HAVE ANY HARDWARE ATTACHING IT TO FRAME:**

A ½" hole will have to be drilled through the plate with the slot in the frame serving as a template. Use the supplied ½"-13 x 3" hex head cap screws and ½" x 2" x ¼" thick flat washers to fasten the upper bracket to the frame with the ½"-13 x 3" hex head cap screw going all the way through the hole that was drilled through the fifth wheel hitch plate.

**For Step 11-13, use the parts in Subgroup C, as listed on Page 3.**

## 11 SECURE A FOUR HOLE LOCATING BRACKET TO EACH SIDE OF THE LOWER BRACKET

Fasten two of the four hole locating brackets to the top side of the lower bracket closest to the leaf spring using four 3/8"-16 x 1¼" carriage bolts, four 3/8" flat washers, and a 3/8" Nyloc nut for each bolt, (as shown in Figures 11A & 11B with arrows).

Torque to 16 ft lbs, 22 N•m.

### For SRW (Single Rear Wheel):

Insert a 10" carriage bolt into the unused square hole (circled in Figure 11B) from the top of the lower bracket.

### For DRW (Double Rear Wheel):

Insert a 10" carriage bolt on either side of the air spring in the 2nd slot from the edge of the bracket (shown with arrows in Figure 11C), beside the carriage bolt previously installed securing the Four Hole locating bracket.

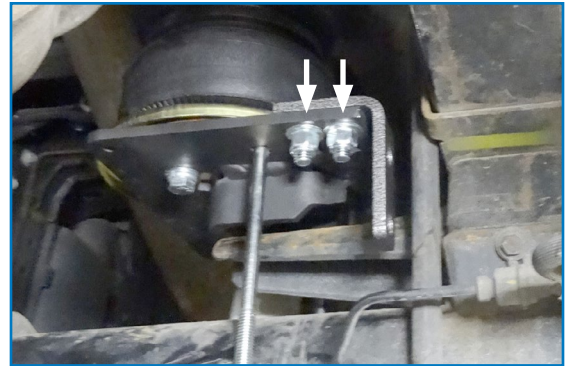

11A

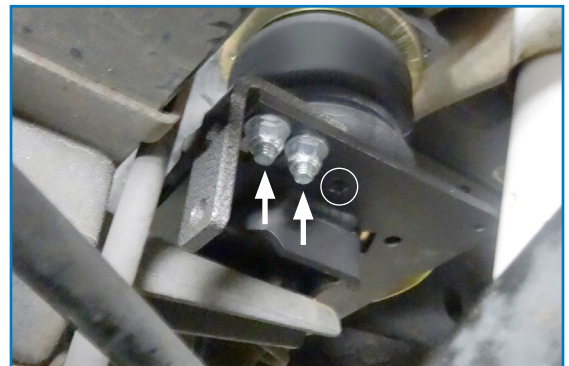

11B

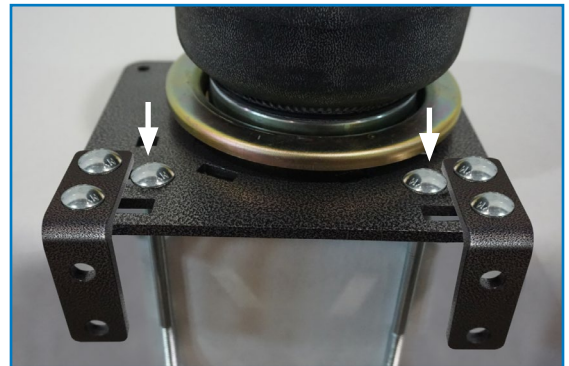

11C

## 12 SECURING THE AIR SPRING ASSEMBLY TO THE LEAF SPRING

Position a spring Clamp Bar on the side of the leaf spring U-bolt closest to the tire (shown with an arrow in Figure 12A) and attach it to the bottom hole of each Four Hole locating bracket with two 3/8"-16 x 5" hex head cap screws, 3/8" flat washers and 3/8" Nyloc nuts.

Torque to 16 ft lbs, 22 N•m.

When secured to both locating brackets, the spring clamp bar will secure the lower bracket of the air spring assembly to the leaf spring. (Reference Figure 12B on following page).

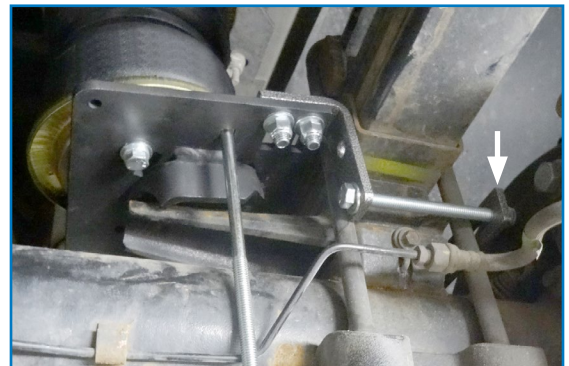

12A



For Step 13, use the parts in Subgroup F, as listed on Page 3.

### 13 SECURE THE AIR SPRING ASSEMBLY TO THE AXLE WITH AN AXLE STRAP

Position an axle strap on to the two 10" carriage bolts (installed in Step 11), with the "U" facing UP towards the axle housing (as shown in Figure 13A) on the bottom of the axle.

Attach the axle strap using two 3/8" Nyloc nuts and 3/8" flat washers (see Figure 13A & 13B for reference).

Torque to 16 ft lbs, 22 N•m.

For Step 14, use the parts in Subgroup D, as listed on Page 3.

### 14 INSTALL HEAT SHIELD

Bend tabs on the heat shield so the required 1/2" of dead space exists between the heat shield and exhaust when attached.

Attach the heat shield to the exhaust pipe on passenger side using two ring clamps (shown in Figure 14). Each hose clamp holds a tab against exhaust pipe.

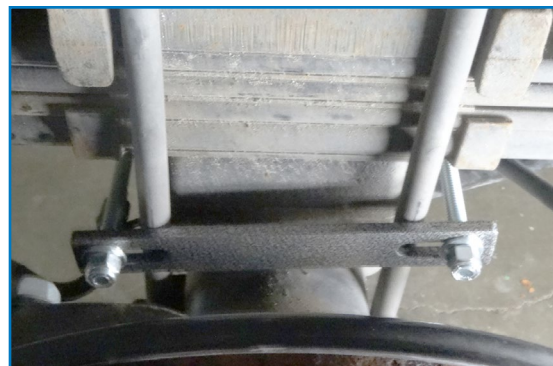

12B

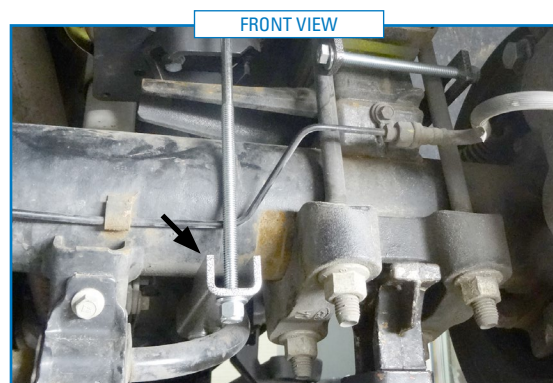

13A

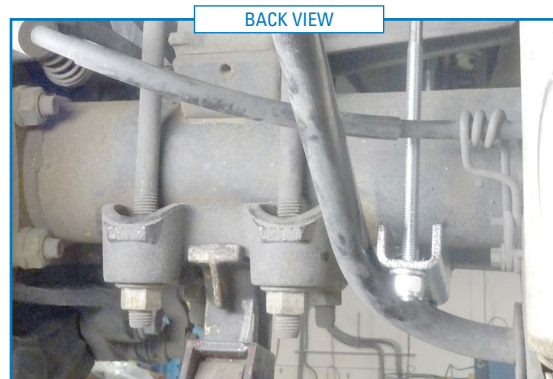

13B



14

## 15 INSTALL AIR LINE

**PLEASE NOTE:** This kit contains push-to-connect fittings; using scissors or wire cutters to cut the nylon airline will distort the line and cause the connection to leak. THE AIRLINE MUST BE CUT OFF SQUARELY WITH THE NYLON HOSE CUTTER PROVIDED IN THIS KIT OR A SHARP UTILITY KNIFE

Provided in air spring kit are two fill valves. The most common place to install is in place of license plate fasteners (See Figure 15A). Alternatively, two 5/16" holes can be drilled in a convenient location.

Cut air line assembly into two equal lengths with hose cutter.

Install one air line, route the nylon air line to an air spring fitting and cut the hose. Moisten the end of the air line prior to inserting it into the fitting and push it in until it stops. Repeat with the other fill valve.

Place a 5/16" nut on the air valve. Leave enough of the inflation valve in front of the nut to extend through the hole, install a flat washer, and 5/16" nut and cap (reference Figure 15B for assembly). There should be enough valve exposed after installation—approximately 1/2"—to easily apply a pressure gauge or an air chuck.

Secure airlines using the tie-straps, away from moving items and heat sources.

**If an in-cab inflation kit is being installed, follow the instructions provided with that kit now.**

Repeat Steps 6-15 for the other side of the vehicle.

## 16 CHECK SYSTEM FOR LEAKS

Inflate both air springs to 90 psi and then use a mixture of dish soap and water on all air line connections to detect any air leaks. Large, expanding bubbles indicate a leak (as shown in Figure 16).

Repair as necessary and retest.

Inflate air springs to a predetermined value and on following day recheck pressure.

If one or both of air springs have lost pressure, an air leak is present. Leak must be repaired, and then retested until no leaks exist.



15A

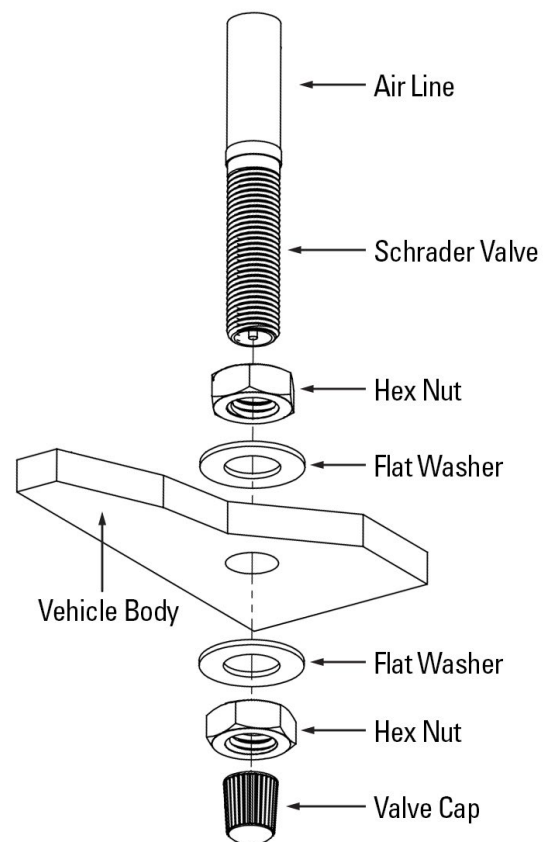

15B



16

## 17 AFTER COMPLETING THE INSTALLATION

### PLEASE REMEMBER:

Install wheels and torque fasteners to manufacturer's specifications.

Re-torque all fasteners after first 500 miles of driving.

For safe and proper operation, never operate the vehicle under minimum of 10 psi or over maximum of 100 psi in air springs. Staying within pressure limit will ensure maximum air spring life. Failure in doing so may result in a void warranty

**⚠ Do not exceed maximum vehicle payload. Failure to do so may result in failure of the air suspension kit and/or damage to your vehicle.**

.....

**Thank you again, and congratulations on the installation of the air suspension kit.**

## OPTIONAL ACCESSORIES

Optional dual needle air gauges are available to monitor pressure in each spring from vehicle cab, as well as a full line of air compressors, air tanks, and solenoids built to work with and control your air spring system.

## OPERATING YOUR VEHICLE WITH AIR SUSPENSION

Air springs have minimum and maximum pressure requirements. Never operate your vehicle with less than 10 psi in air spring and never inflate air springs over 100 psi. Damage to air springs will result.

Check air pressure in air springs daily for first couple of days to ensure a leak has not developed. Air springs are designed to maintain the vehicles stock ride height with a load. Do not use the air springs as a means to lift vehicle with no load. This will result in a harsh ride.

## SERVICING YOUR VEHICLE WITH AIR SUSPENSION

When lifting the vehicle with a floor jack or hoist on the frame, never allow the air spring to limit the travel of the axle. Try to always jack the vehicle on the axle. Suspending the axle with the air spring limiting the axle travel will damage the air spring and void the air spring warranty.

## WARRANTY

**The owner's warranty will be void if air springs are run with less than the minimum of 10 psi. See additional warranty for details.**

.....