

Installation Manual



AIR SUSPENSION KIT

Ford F-150 (4WD)*

Ford F-150 (2WD)*

**Will not fit F-150 Raptor models*

Use the most advanced air springs on the market to eliminate your vehicle's sag, sway and bottoming out. This heavy duty air suspension kit levels your truck's stance while providing added support for an overall smooth and safe ride.

** See application guide for proper fitment.*

L6335_REV10_04.16.2024

Thank you and congratulations on the purchase of an Air Suspension kit. Please read the entire manual prior to starting the installation to ensure you can complete it once started.

IMPORTANT

This air suspension kit will not increase the GVWR (*Gross Vehicle Weight Rating*), as the GVWR is determined by the vehicle manufacturer. **Do not exceed the maximum capacity listed by the vehicle manufacturer.**

For safe and proper operation of the vehicle, never exceed a maximum of 100PSI in the air springs. Staying under the pressure limit will ensure maximum air spring life. **Failure in doing so may result in damage to your vehicle and/or a void warranty.**

SAFETY WARNINGS!

! Please read and abide the instructions found in this manual, paying close attention to the helpful, cautionary or dangerous warning icons highlighting important safety recommendations and maintenance suggestions throughout this manual.

+ **HELPFUL INSTALL TIP**
Additional information that could potentially make the job a little easier.

! **PLEASE USE CAUTION**
Unsafe practices could result in damage to you or your vehicle, or others.

! **DANGER WARNING**
Hazards which could result in severe personal injury or death.

! Serious personal injury or death may result from an air spring failure or accident due to improper installation or air spring pressure operation or maintenance.

! Inflating an unsecured air spring is dangerous. If it bursts, it could be hurled into the air with explosive force resulting in serious personal injury or death. Never inflate an air spring unless it is secured to the vehicle.

! Removing and replacing air springs can be dangerous. This is only a job for a qualified service professional. Never perform air spring service procedures without proper training, tools, and equipment.

BEFORE STARTING THE INSTALLATION

PLEASE NOTE: This manual is used across multiple kit variations. The 4WD kit is used as reference throughout most of the manual but the procedure remains the same across all part numbers (unless specifically noted in a step).

- Ensure the application information is correct for the make, model and year of the vehicle you are installing the kit on.
- Some vehicles are equipped with a rear wheel brake proportioning valve. Check with the manufacturer before installing the air spring kit, as it may affect braking performance.
- It is recommended to use a good quality anti-seize on all fasteners. This will reduce the chance of corrosion on the fasteners and will help facilitate removal, if required at a later date.

! **PLEASE NOTE:** This kit contains push-to-connect fittings; using scissors or wire cutters to cut the nylon air line will distort the line and cause the connection to leak. The air line must be cut off squarely with the hose cutter provided in this kit, or a sharp utility knife. **Failure to do so may void the warranty.**

! **WARNING:** This product can expose you to the chemical Hexavalent Chromate, which is known to the State of California to cause cancer and birth defects or other reproductive harm. **For more information go to www.P65Warnings.ca.gov**

KIT CONTENTS

Please confirm the items below are provided in your kit before starting the installation. Reference the kit explosion diagram on the following page for part assembly.

4WD HEAVY DUTY KITS		QTY	PART #
A*	Double Convoluted Spring	2	HP10000

4WD HEAVY DUTY JOUNCE BUMPER KITS		QTY	PART #
A*	Double Convoluted Spring w/ Jounce Bumper	2	HP10000J

2WD HEAVY DUTY KITS		QTY	PART #
A*	Single Convoluted Spring	2	HP10083

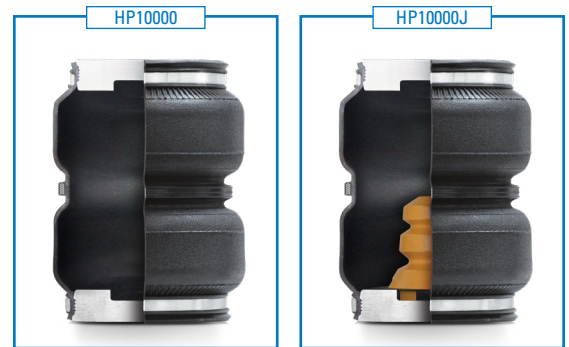

KIT CONTENTS		QTY	PART #
B	Roll Plate, 4.5" Diameter	4	HP10054
C	Fitting, 1/4" NPT Brass Straight	2	HP1099
D	Upper Bracket, Driver Side Air Spring	1	HP1418
E	Upper Bracket, Drivers Side Frame	1	HP1417
F	Upper Bracket, Passenger Side Frame	1	HP1424
G	Upper Bracket, Passenger Side Air Spring	1	HP1425
H	Bracket, Lower	2	HP1419
I	Plate, Lower Bracket Adjustment	2	HP1423
J	Extension, Lower Bracket	2	HP1426
K	Axle Strap	3	HP1383
L	Round Strap, Axle	1	HP0009
M	Spacer, Sleeve	1	HP1422
N	Bolt, 3/8" - 24 x 3/4" Countersunk	4	HP1008
O	Bolt, 3/8" - 24 x 1" Hex Head	4	HP1183
P	Bolt, 3/8" - 16 x 1.25" Carriage	8	HP1149
Q	Bolt, 3/8" - 16 x 7" Carriage	1	HP1409
R	Bolt, 3/8" - 16 x 10" Carriage Bolt	7	HP1329
S	Bolt, M10 x 1.5 x 35mm Button Head	2	HP1414
T	Washer, 3/8" Split Lock	4	C18007
U	Washer, 3/8" Flat	16	C653
V	Nut, 3/8" Nylon Lock	6	HP1000
W	Nut, M10 x 1.5mm Clip-On Barrel	2	HP1421
X	Heat Shield	1	HP0012
Y	Worm Gear Ring Clamp 2.5" to 3.5"	2	HP1001

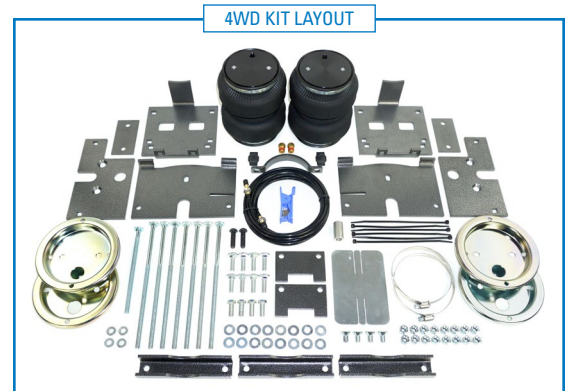

REQUIRED TOOLS

- Hoist or Floor Jack
- Safety Stands
- Safety Glasses
- Torque Wrench
- Standard Combination Wrenches
- 7/32" Hex Allen Wrench
- Ratchet
- Metric & Standard Sockets
- Hose Cutter (included) or Sharp Utility Knife
- Pipe Thread Sealant
- Spray Bottle with Dish Soap/Water
- Air Compressor/Compressed Air Source (to test/fill air springs)

KIT EXPLOSION DIAGRAM

DRIVER SIDE ASSEMBLY SHOWN — 4WD KIT USED AS EXAMPLE
 (See following page for Passenger side)

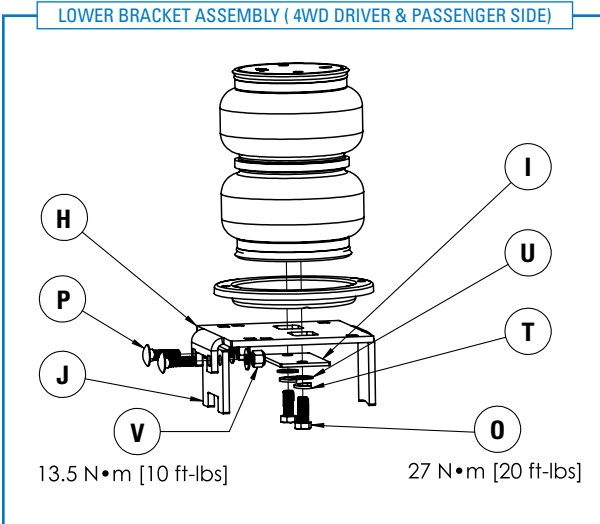
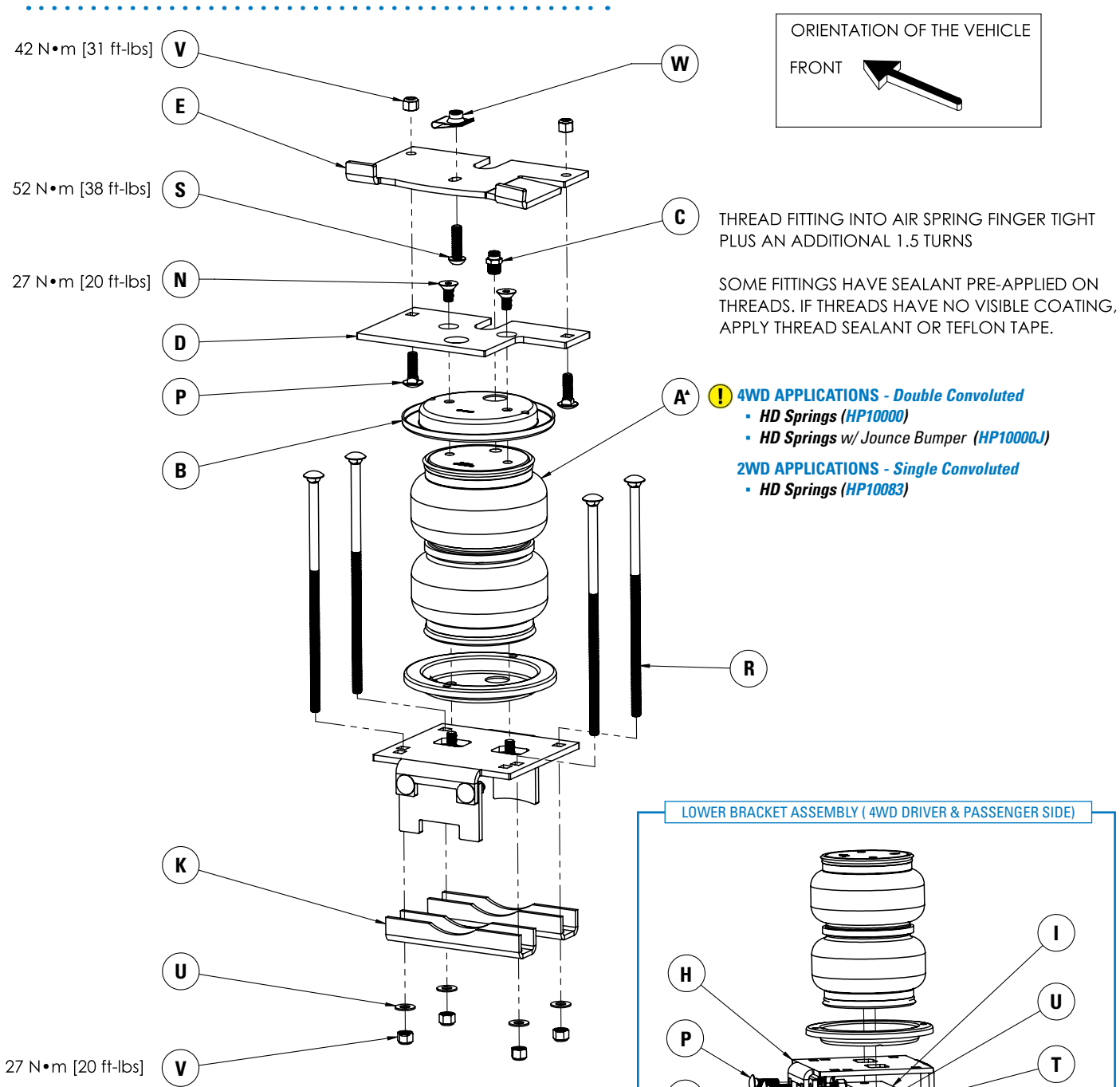

KIT EXPLOSION DIAGRAM

PASSENGER SIDE ASSEMBLY SHOWN — 4WD KIT USED AS EXAMPLE

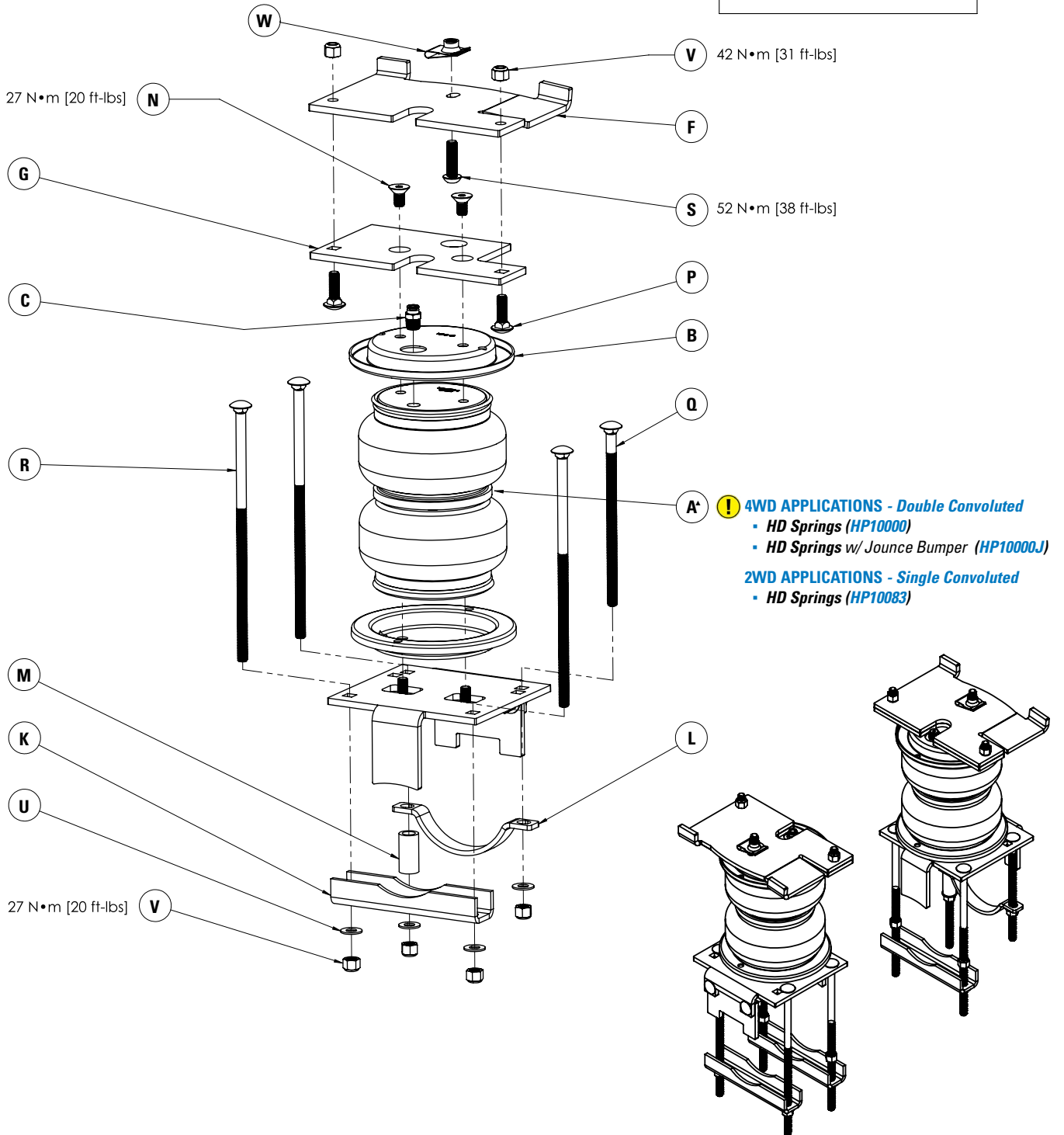
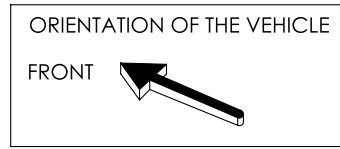

INSTALLATION INSTRUCTIONS

1 MEASURE STOCK RIDE HEIGHT & CLEARANCE

Park the vehicle on a level surface and remove any unnecessary weight from the vehicle to attain a "Normal Ride Height".

Using a measuring tape, measure the distance between the center of the wheel hub and the bottom of the fender well (see Figure 1 for reference) this will give you your stock Normal Ride Height.

Note the ride height for all four tires.

Check the clearance between the outside of the frame and the inside of the rear tires (as shown in red in Figure 1B), a minimum of 5" is required for adequate air spring clearance.

2 REMOVE REAR WHEELS

Place wheel chocks in front of and behind both front wheels.

Raise the rear of the truck high enough to remove both wheels and attain a comfortable working height.

Place two jack stands under rear axle (as shown in Figure 1B). Lower the vehicle until the axle is supported by the jack stands and then remove the rear wheels.

3 REMOVE THE JOUNCE BUMPERS

Remove the jounce bumpers from both sides of the vehicle using a 13mm socket and an extension.

2004-2008 Vehicles will have universal nuts that hold the jounce bumpers in place. Once the jounce bumper has been removed, these nuts will have to be replaced by the ones supplied in this kit (HP1421). (See Figures 3A & 3B)

4 CUT OFF EXCESS EMERGENCY BRAKE CABLE HOLDER BOLT

An emergency brake cable holder will be found on the passenger side of the vehicle.

Cut off the excess part of the bolt that sticks out from behind this holder to ensure a flush surface (as shown in Figure 4).

+ *This is necessary to make room for an axle clamp that comes in at a later step.*

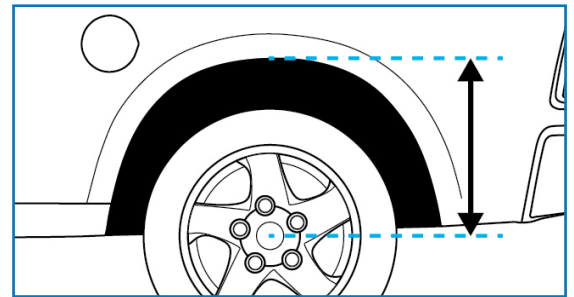

1A

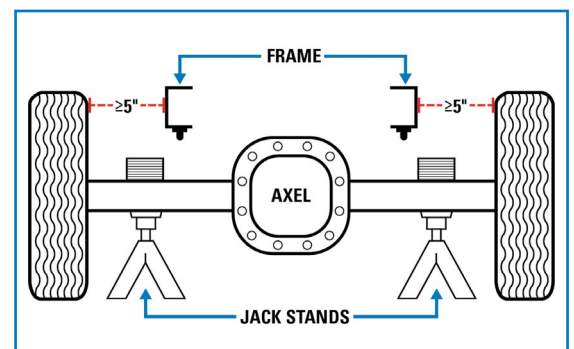

1B

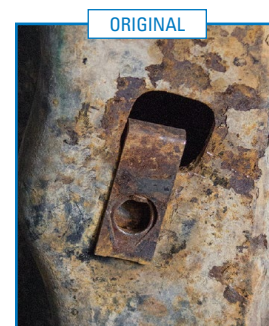

3B

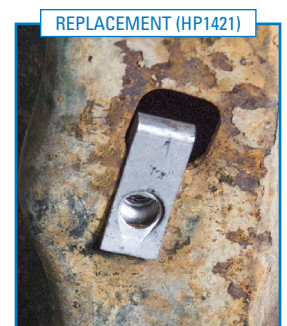

3C

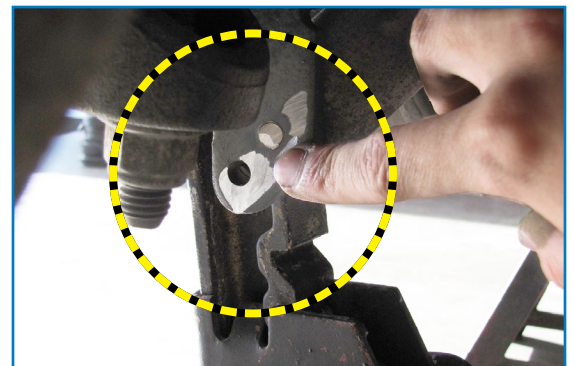

4

5 ATTACH THE UPPER BRACKET

Set both air springs upright on a work bench, so that the ¼ NPT port is facing up and set a roll plate on each of them, aligning each corresponding hole (as shown in Figure 5A's assembly). Apply thread sealant to the supplied air fitting and thread into the top of the air spring. Hand tighten plus one and a half more turns.

- ⊕ **It is recommended to install the fitting before the upper bracket.** Access to the fitting will be limited once the upper bracket is installed on the air spring.

Install the upper air spring bracket onto the air spring with the supplied 3/8" - 24 x 3/4" flat head screws. Torque to 27 N•m (20 ft-lbs).

- ⚠ **PLEASE NOTE: Refer to Figure 5A to determine which assembly is for the driver or the passenger side.**

As mentioned earlier in Step 3, for **2004-2008 Vehicles**: the universal nuts that held the jounce bumpers on the frame have to be replaced with the universal nuts supplied in this kit.

Take an upper frame bracket and attach it to the appropriate side of the vehicle. (Refer to Figure 5B & 5C to determine the correct side for each upper frame bracket).

Once the correct bracket has been determined, attach each upper frame bracket onto the frame with the two bent tabs on the outside, facing up.

2004-2008 Vehicles the upper frame bracket will bolt onto the universal nuts previously attached using the supplied M10 - 1.5 x 35mm button head screw.

Newer model 2009-2014 Vehicles do not require the universal nut as the screw will thread straight into the frame.

Torque to 52 N•m (38 ft-lbs).

6 INSTALL AIR BAG ASSEMBLIES

Attach the driver and passenger assemblies to the frame brackets using the carriage bolts, flat washers and the nylon lock nuts.

Torque to 42 N•m (31 ft-lbs).

- ⊕ **The air fitting should be on the inside of the frame.**

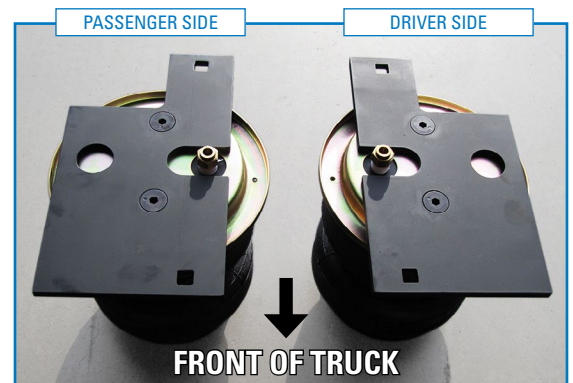

5A

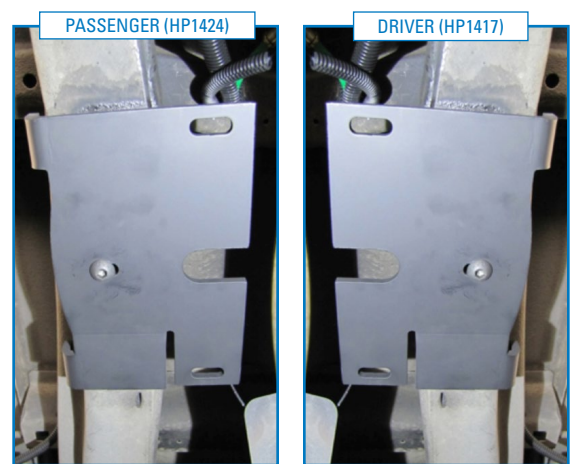

5B

5C



6

7 ATTACH THE LOWER BRACKET TO THE AXLE

- ⊕ *The lower brackets are the same and are not specific to each side of the vehicle as the upper brackets are.*

The shorter tab on the lower bracket has to sit in between the stock u-bolts that hold the leaf spring on the axle.

For 2004-2008 Vehicles they should sit directly on top of the jounce bumper strike plate.

2009-2014 Vehicles do not have this strike plate and therefore an extension must be bolted onto the short tab of the lower bracket (as shown in Figure 7A) using the supplied 3/8" - 16 x 1.25" carriage bolts, 3/8" - 16 nyloc nuts, and 3/8" flat washers. Torque to 27 N•m (20 ft-lbs).

For the Driver Side, (using Figures 7C & 7E as reference for part assembly) use two large axle clamps, four 3/8" - 16 x 10" carriage bolts, 3/8" - 16 nyloc nuts, and 3/8" flat washers to clamp the lower bracket onto the axle, making sure to utilizing the correct "Driver Side" specific hole's in the lower bracket

The Passenger Side (shown in Figures 7B & 7D) will require one large and one small axle clamp, one 7" carriage bolt, 3 - 10" carriage bolts and the supplied sleeve spacer which **must** be added to the front side of the small axle clamp (as shown and circled in Figure 7F). Torque to 13.5 N•m (10 ft-lbs).

- ⚠ **PLEASE NOTE: It is very important to distinguish the different sides of each assembly. Pay close attention to details in Figures 7B-7F to ensure a correct and safe installation before proceeding.**

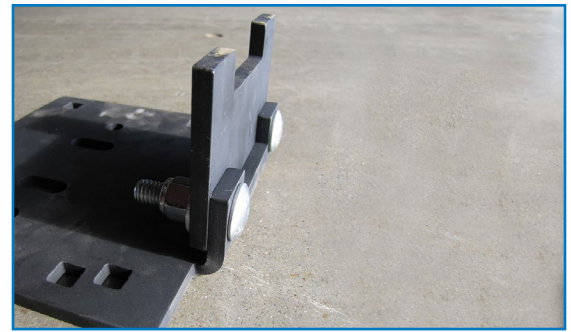

7A

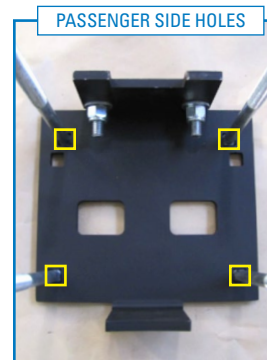

7B

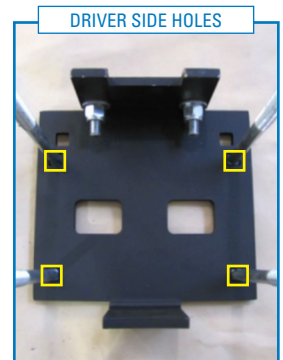

7C



7D



7E

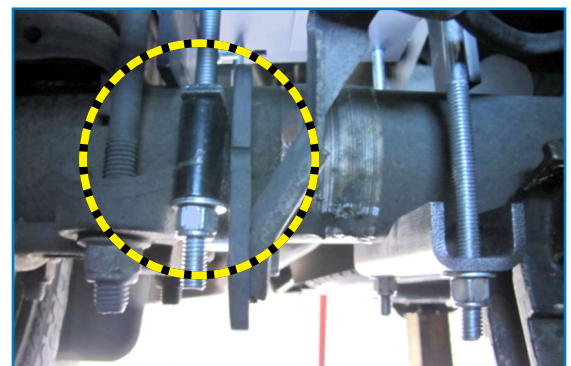

7F

8 ATTACH THE LOWER BRACKET TO THE AIR SPRING

Take a roll plate and set it below the air spring, making sure that the holes match up on each part.

Using the supplied adjustment plates included in this kit (and highlighted with a white arrow in Figure 8), bolt the air spring assembly onto the lower bracket with two 3/8" - 24 x 1.0" hex head cap screws, two 3/8" flat washers, and two 3/8" lock washers.

Torque to 27 N•m (20 ft-lbs)

- + *The axle will need to be raised up accordingly to attach the lower bracket to the air bag.*

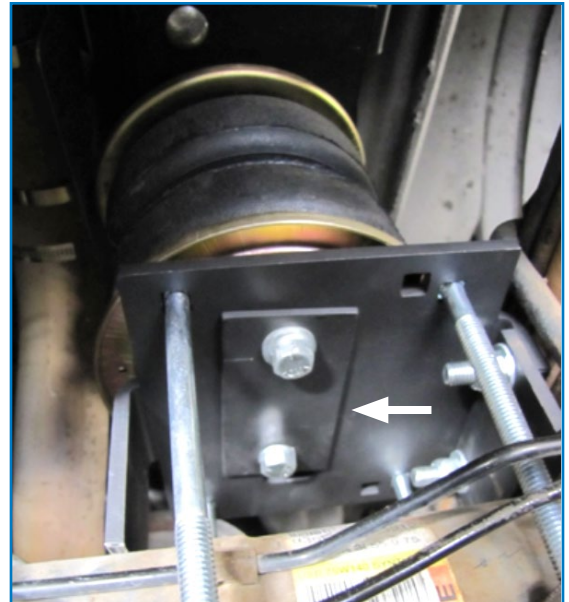

8

9 INSTALL HEAT SHIELD

Bend tabs on the heat shield so the required 1/2" of dead space exists between the heat shield and exhaust when attached.

Attach the heat shield to the exhaust pipe using 2 worm gear clamps. Each hose clamp holds a bent tab against the exhaust pipe.

Ensure heat shield faces toward air spring (as shown in Figure 9).

Installation continues on the following page.



9

INSTALL AIR LINE

Two fill valves are provided in this kit. The most common place to install them is in place of the license plate fasteners. Alternatively, two 5/16" holes can be drilled in a location of your choosing.

Cut the air line assembly into two equal lengths with the hose cutter provided in this kit or a sharp utility knife.

! **PLEASE NOTE:** *This kit contains push-to-connect fittings; using scissors or wire cutters to cut the nylon air line will distort the line and cause the connection to leak. The air line must be cut off squarely with a hose cutter or a sharp utility knife.*

Install one air line at a time starting at the fill valve location. Place a 5/16" nut on the air valve. Leave enough of the inflation valve in front of the nut to extend through the hole, install a flat washer, and 5/16" nut and cap (reference Figure A for assembly). There should be enough valve exposed after installation – approximately 1/2" – to easily apply a pressure gauge or an air chuck.

Route the air line back to the NPT fitting on the air spring, then cut the hose to length. Moisten the end of the air line prior to inserting it into the fitting and push it in until it stops.

Repeat with the other fill valve.

Secure the air lines using the provided tie-straps, away from any moving items and heat sources.

CHECK SYSTEM FOR LEAKS

Inflate both air springs to 90 psi and then use a mixture of dish soap and water on all air line connections to detect any air leaks. Large, expanding bubbles indicate a leak (as shown in Figure B).

Repair as necessary and retest.

Inflate air springs to a predetermined value and on following day recheck pressure. If one or both of air springs have lost pressure, an air leak is present.

! **Leak must be repaired, and then retested until no leaks exist.**

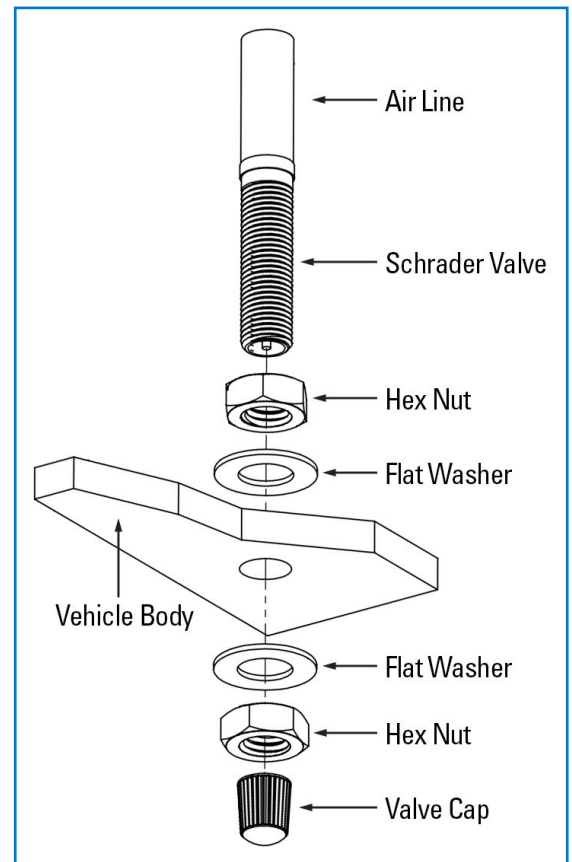

A

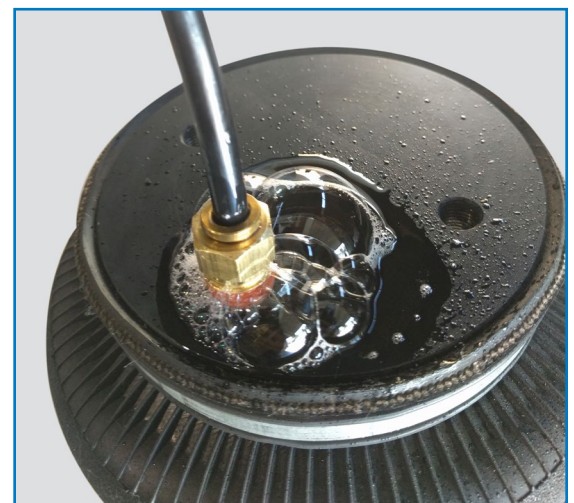

*Air Spring & NPT Air Fitting may differ between kits

B

CONGRATULATIONS! You have completed the install

After Installation continues on the following page.

.....

Thank you again, and congratulations on the installation of your Air Suspension kit.

AFTER COMPLETING THE INSTALLATION

- The air spring must have clearance between itself and the surrounding components to prevent any contact when spring is inflated or compressed. Trimming off excess bolt length may also be required to ensure no contact with the spring or other suspension components can be made once installed.
- If removed, re-install the wheels and torque fasteners to the manufacturer’s specifications. Re-torque all fasteners after the first 500 miles of driving.

OPERATING YOUR VEHICLE WITH AIR SUSPENSION

Air springs have minimum and maximum recommended pressure requirements:

PART #	SPRING STYLE	SPRING TYPE	MIN PSI	MAX PSI
HP10189	In-Coil	STANDARD DUTY	5 PSI	70 PSI
HP10560		STANDARD DUTY		
HP10001	Sleeve Style	STANDARD DUTY	10 PSI	100 PSI
HP10173		STANDARD DUTY		
HP10199		STANDARD DUTY		
HP10083	Single Convoluted	HEAVY DUTY	5 PSI	100 PSI
HP10083J		HEAVY DUTY with JOUNCE BUMPER	0 PSI* / 5 PSI	100 PSI
HP10000	Double Convoluted	HEAVY DUTY	5 PSI	100 PSI
HP10000J		HEAVY DUTY with JOUNCE BUMPER	0 PSI* / 5 PSI	100 PSI
HP10068	Large Double Convoluted	HEAVY DUTY	5 PSI	100 PSI
HP10438	Double Convoluted	EXTREME DUTY	5 PSI	100 PSI
HP10438J		EXTREME DUTY with JOUNCE BUMPER	0 PSI* / 5 PSI	100 PSI

** Springs with a jounce bumper can be run at zero PSI when vehicle is unloaded only*

For safe and proper operation, never operate the vehicle over the maximum listed PSI in the air springs. Staying under the pressure limit will ensure maximum air spring life. **Failure in doing so may result in damage to your vehicle and/or a void warranty.**

! It is recommended to check the air pressure in your air springs daily for first couple of days to ensure a leak has not developed.

Air springs are designed to maintain the vehicle’s stock ride height with a load. Do not use the air springs as a means to lift vehicle with no load. This will result in a harsh ride.

SERVICING YOUR VEHICLE WITH AIR SUSPENSION

When lifting the vehicle with a floor jack or hoist on the frame, never allow the air spring to limit the travel of the axle. Try to always jack the vehicle on the axle. Suspending the axle with the air spring limiting the axle travel will damage the air spring and void the air spring warranty.

WARRANTY

See additional warranty included with this kit for details.